

$7-5/8'' \times 7-5/8'' \times 1/2''$

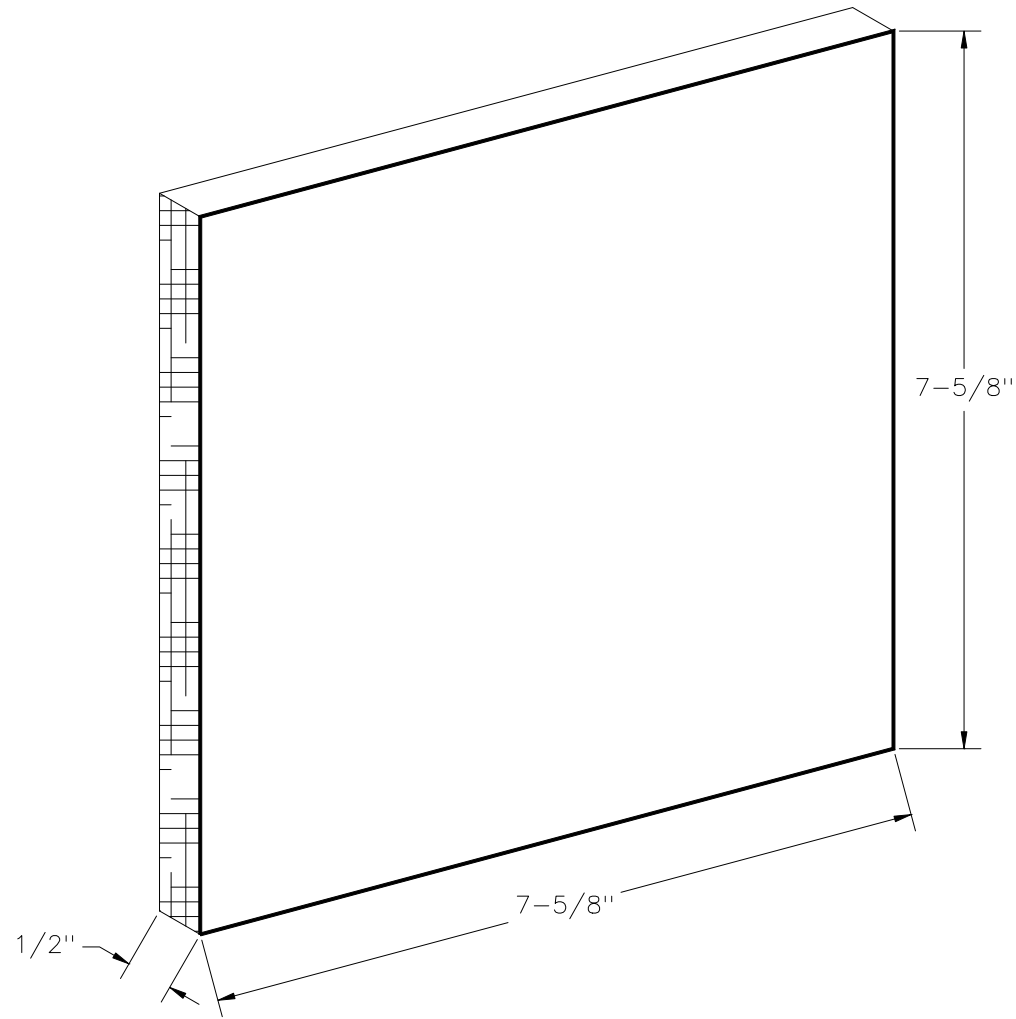

Endicott Clay Products Co