

ROOF TO ROOF SEAL SYSTEM. 8" (RR-8)

	Movement	
Expansion		Compression
Top Seal	12"	To 1-1/4"
Gutter	14"	To 1-1/4"

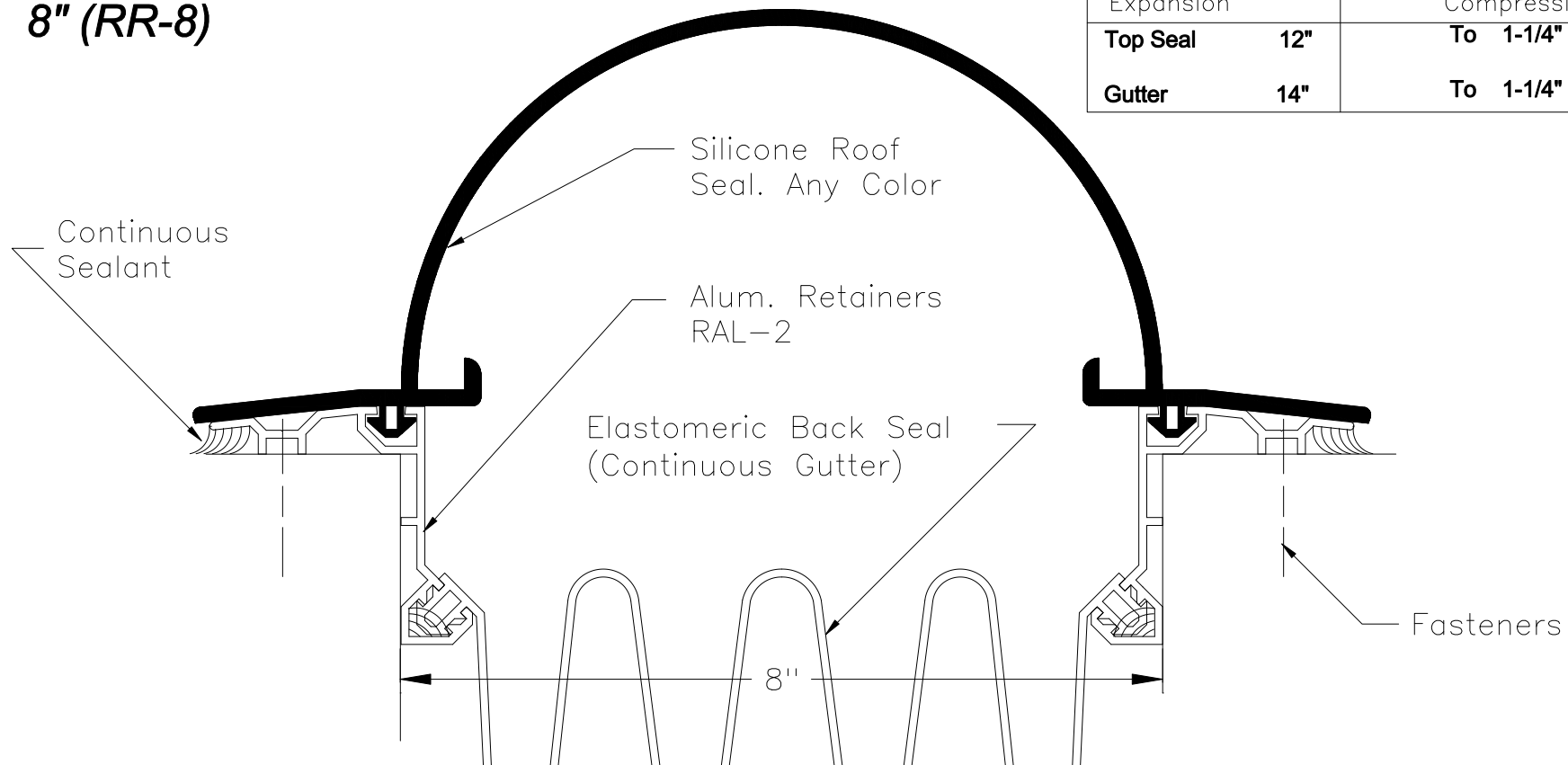

GENERAL SPECIFICATIONS

RR-SYSTEMS ARE SEISMIC EXPANSION JOINT SEALS FOR ROOF APPLICATIONS. THEY ARE EXTRUDED FROM SILICONE AND PRODUCED BY THE MICHAEL RIZZA CO. THE FACE AND ELASTOMERIC BACK SEAL ARE SECURED IN ALUMINUM RETAINERS USING A HIGH QUALITY SILICONE COMPATIBLE SEALANT. ALUMINUM EXTRUSIONS ARE 6063-T5 ALLOY AND TEMPER. SILICONE EXTRUSIONS MEET ASTM D2000, 4GE, 709, M, ARE UV STABILIZED AND DO NOT PROPAGATE FLAME. COLOR, AS SELECTED BY THE ARCHITECT.

FASTENERS

MICHAEL RIZZA CO. RECOMMENDS THAT ALUMINUM RETAINERS BE MECHANICALLY FASTENED AT 18" O.C. INSTALLER SHALL DETERMINE APPROPRIATE FASTENERS (BY OTHERS) DEPENDENT ON STRUCTURAL MATERIAL. STRUCTURAL ADHESIVES (BY OTHERS) MAY BE USED IN CONJUNCTION WITH, OR IN PLACE OF, FASTENERS IF APPROVED BY ARCHITECT OR MICHAEL RIZZA CO. AND BE IN ACCORDANCE WITH SEALANT MANUFACTURER'S RECOMMENDATIONS.



NO PART OF THIS DESIGN MAY BE REPRODUCED OR COPIED IN ANY FORM OR BY ANY MEANS, GRAPHIC ELECTRONIC OR MECHANICAL, INCLUDING PHOTOCOPYING, WITHOUT WRITTEN PERMISSION OF THE DESIGNER.

MICHAEL RIZZA COMPANY CO. INC.
P.O. BOX 545 BORING, OR 97009
PHONE: 503-663-2418 FAX: 503-663-9685

PROJECT

DATE:
8.12.9

JOB#:

DRG. NO.

SCALE:
NONE

DRAWN:
JBD

JOB: