

MultiDrain®

We Drain Your Site, Not Your Budget!

MULTIDRAIN SYSTEMS, INC.
 P.O. BOX 88
 BARIUM SPRINGS, NC 28010
 TOLL FREE: 1-800-433-1119
 PHONE: (704) 508-1010
 FAX: (704) 508-1011
 www.multidrain.com

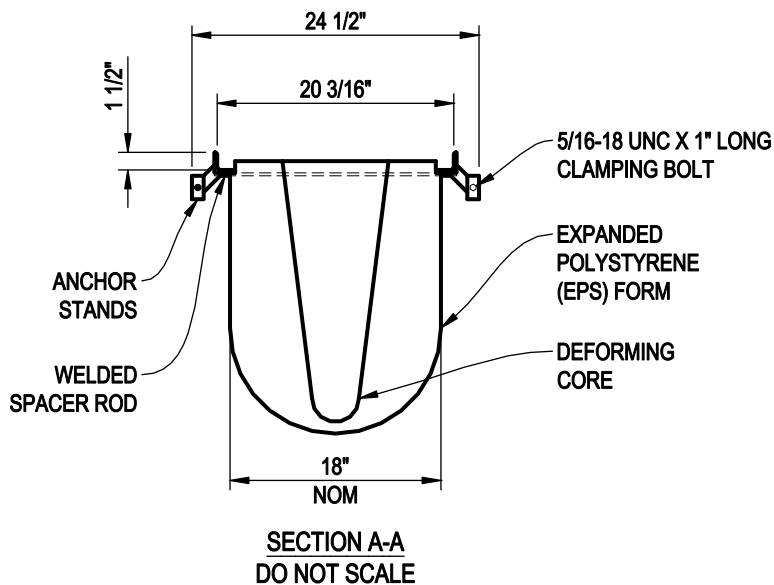
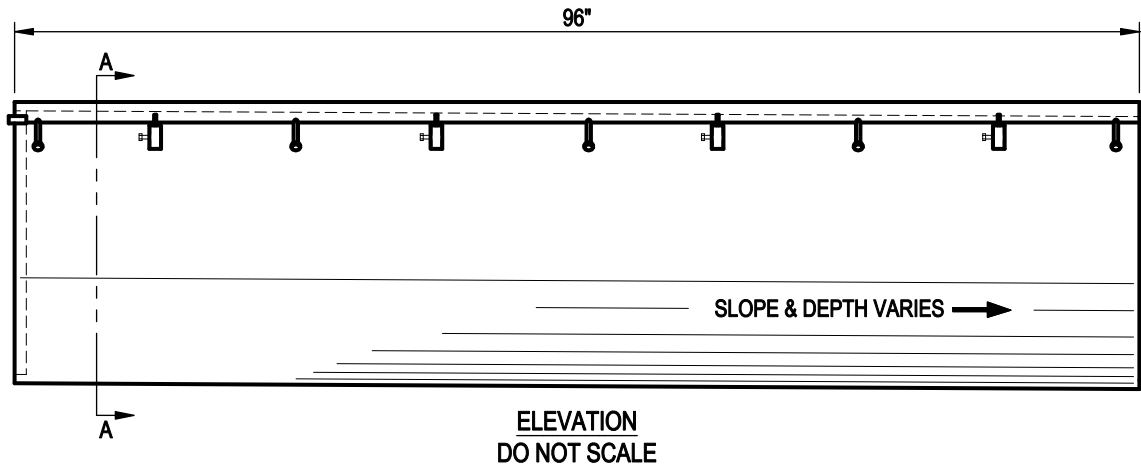

FINISH SPECIFICATION
 GRATE FRAME: BLACK PAINT - STANDARD
 HOT DIP GALVANIZE - OPTIONAL
 CAST GRATE : BLACK PAINT - STANDARD
 HOT DIP GALVANIZE - OPTIONAL

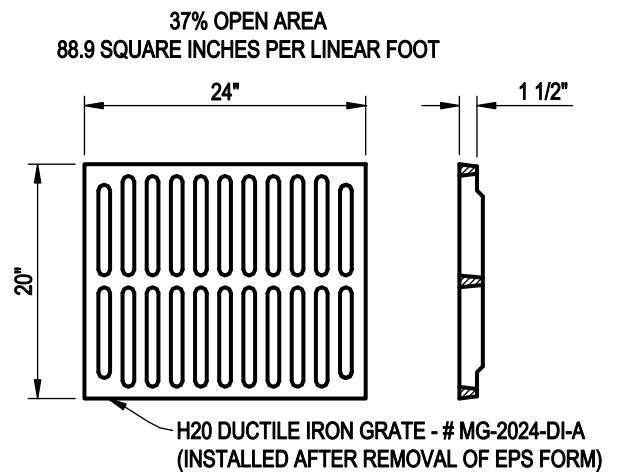

NOTES:

1. INSTALLATION TO BE COMPLETED IN ACCORDANCE WITH MANUFACTURERS SPECIFICATIONS.
2. DO NOT SCALE DRAWINGS.

 **EconoDrain® Series #18**
 DUCTILE IRON GRATE (STANDARD)