

DL SERIES DOORS

DIMENSIONS IN
() ARE METRIC.

TOP TO TOP
4 1/2" HINGES ONLY
1 3/4" DOOR

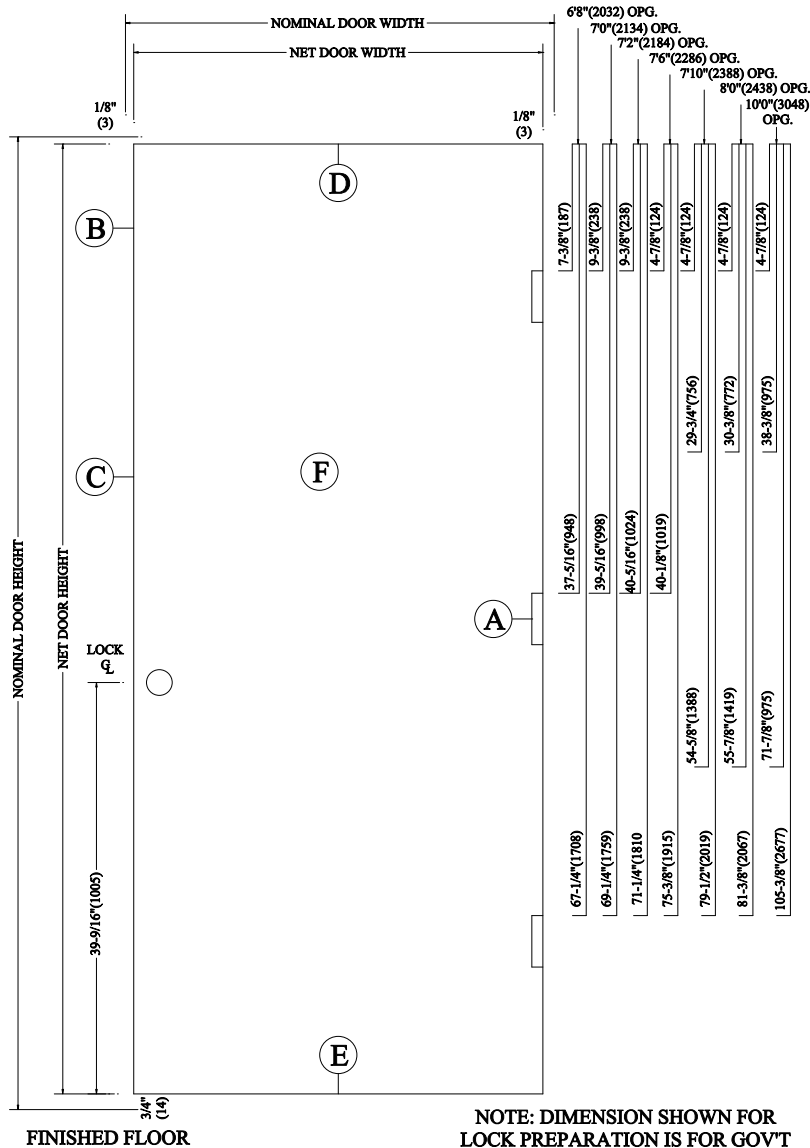

NOTE: DIMENSION SHOWN FOR LOCK PREPARATION IS FOR GOV'T SERIES 160, 161, 190 AND UNIT LOCKS. WHEN GOV'T SERIES 86 LOCK IS USED (ANSI A115.1) DIMENSION TO CENTER OF LOCK IS 3/8" (10) LESS THAN INDICATED.

CONSULT FACTORY FOR HARDWARE NOT SHOWN.

A

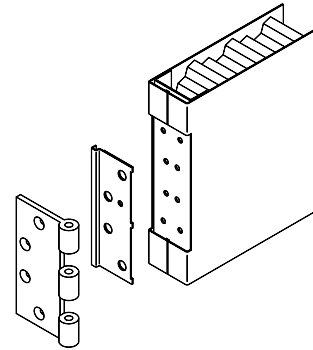

Continuous or segmented 16 gauge reinforcement with provision for 4 1/2" x 4 1/2" full mortise template hinges

E

DOOR BOTTOM

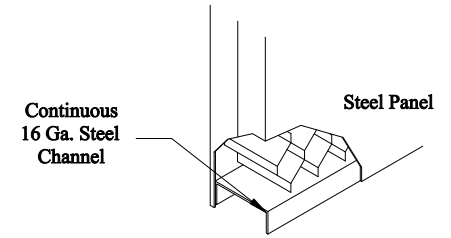

Continuous 16 Ga. Steel Channel

Steel Panel

F

14 Ga. Astragal for Double Doors (opt.)

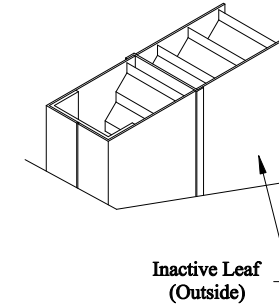

B

Continuous Welded Edge Seam

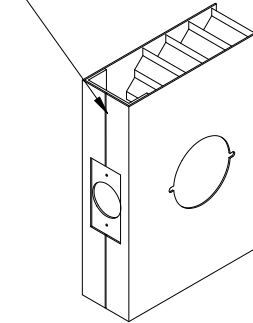

SPECIFIED CORE

D

Flush Top Continuous 16 Ga. Steel Channel

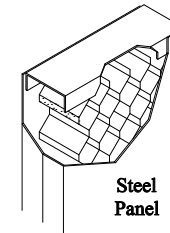

Steel Panel

12 Ga. Closer Reinforcement when specified

C

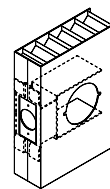

16 Ga. steel cylindrical lock reinforcement with provisions for Gov't Series 160 or 161 cylindrical lock sets (2-3/4" backset) and ANSI A115.2 lock front (1-1/8" x 2-1/4")

16 Ga. Mortise Lock reinforcement with provisions for Gov't Series 60 mortise lockset and ANSI A115.2 Lock Front (1-1/4" x 8)

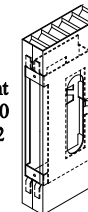

CONSTRUCTION AVAILABLE

- 20, 18, OR 16 GAUGE STEEL
- COLD ROLLED OR A-60 GALV STEEL
- HONEYCOMB CORE
- INSULATED CORE(POLYSTYRENE)
- TEXTURED STEEL

