

DOUBLE EGRESS DETAILS - MITERED

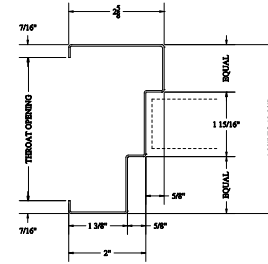

1 3/8" (35) FACE STANDARD

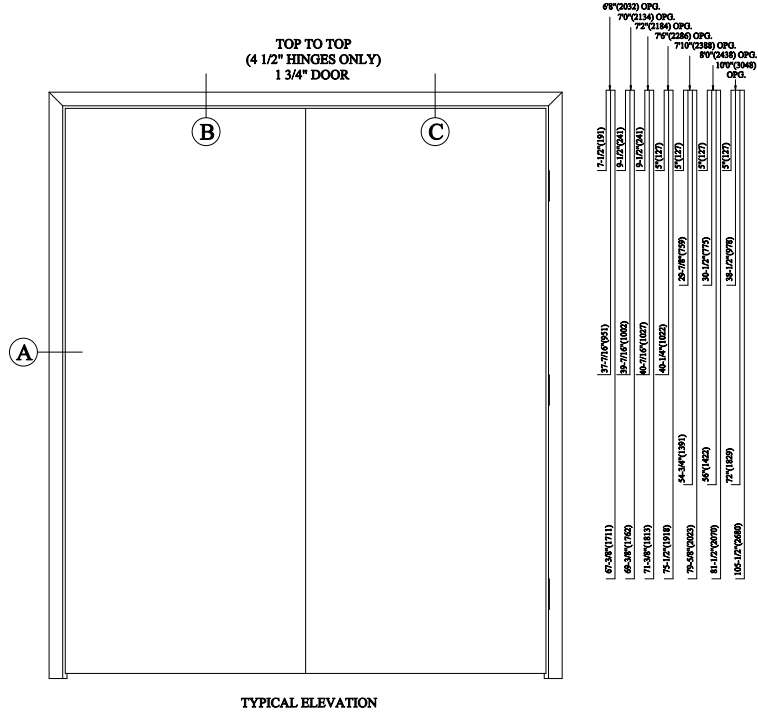
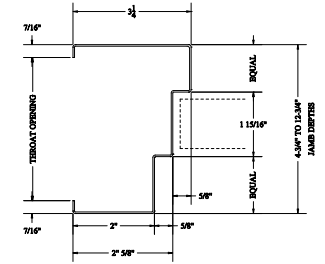

2" (51) FACE STANDARD

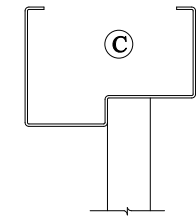
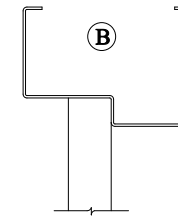

K. D. HEADER

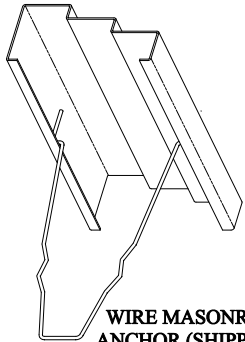

WIRE MASONRY ANCHOR (SHIPPED LOOSE, NON UL ONLY)

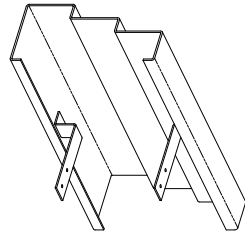

WOOD STUD ANCHOR (WELDED IN)

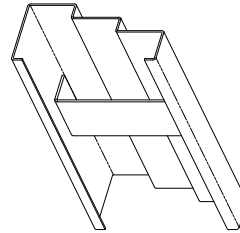

STEEL STUD ANCHOR (WELDED IN)

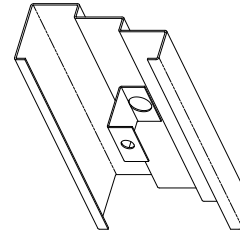

PREPARED OPENING ANCHOR (WELDED IN)

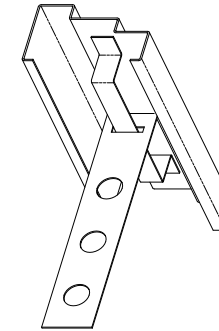

U.L. MASONRY ANCHOR (WELDED IN)

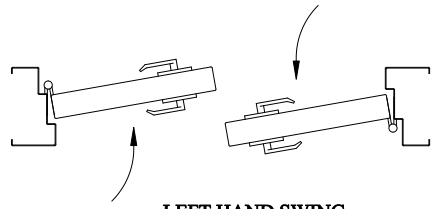

LEFT HAND SWING

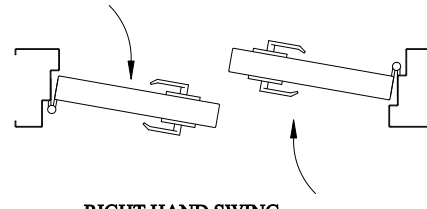

RIGHT HAND SWING

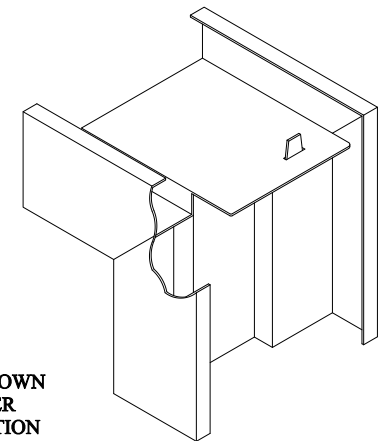

KNOCK-DOWN CORNER CONNECTION

ALL DOUBLE EGRESS OPENINGS SHALL BE SUPPLIED AS RIGHT HAND SWING UNLESS OTHERWISE SPECIFIED

DIMENSIONS IN () ARE METRIC