

THERMATITE T150-MR

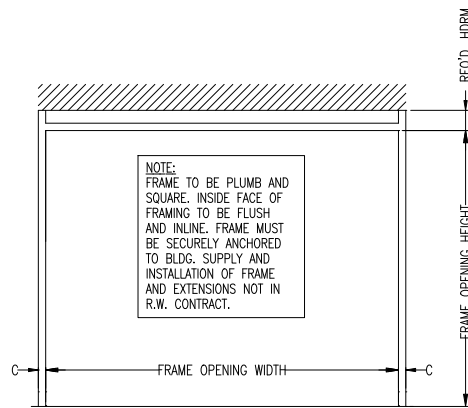

INTERIOR ELEVATION OF FRAMING BY OTHERS

ISSUE NO.	REV. LET.	ISSUES OR REVISIONS	DATE	BY	APP.
1					

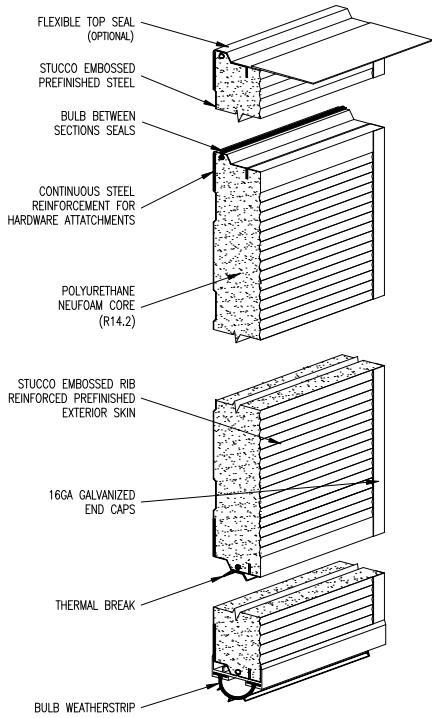
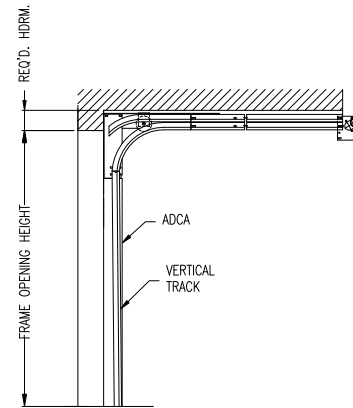

CROSS SECTION

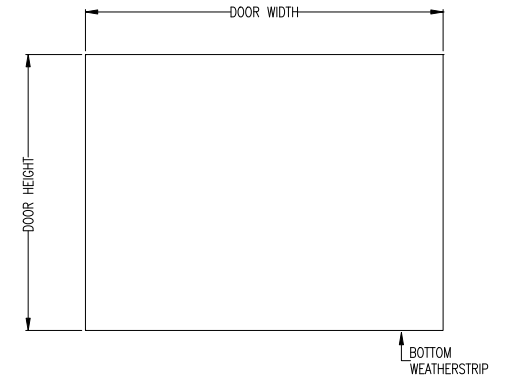

EXTERIOR ELEVATION

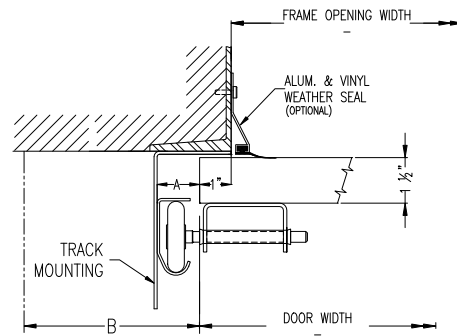

STEEL JAMB DETAILS

DOOR WIDTH		ADCA	A	B	C
DOOR HEIGHT		2"	1 1/2"	3 1/2"	2 1/2"
FRAME OPENING WIDTH		3"	2"	4"	3"
FRAME OPENING HEIGHT		VERTICAL TRACK			
HEADROOM REQ'D.		HORIZONTAL TRACK			
TRACK MOUNTING	<input type="checkbox"/> ADCA <input type="checkbox"/> BRACKET	LITES			

TRUSSING	WIND LOAD
OPTIONS	

TITLE THERMATITE T150-MR DOOR C/W ___" ROLLTITE LOW HEADROOM REAR MOUNT HARDWARE

CLIENT

SETS REQUIRED

TAG

CLIENT'S ORDER NO.

R-W ORDER NO.

Richards-Wilcox

CANADA INC.
TORONTO, ONTARIO

DRAWN		SCALE	NTS
CHECKED		DRAWING NO.	
APPROVED		SHEET NO.	