

THERMATITE T175-MR

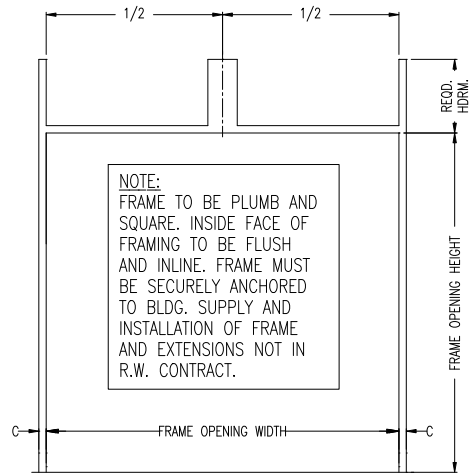

INTERIOR ELEVATION OF FRAMING BY OTHERS

ISSUE NO.	REV. LET.	ISSUES OR REVISIONS	DATE	BY	APP.
1					

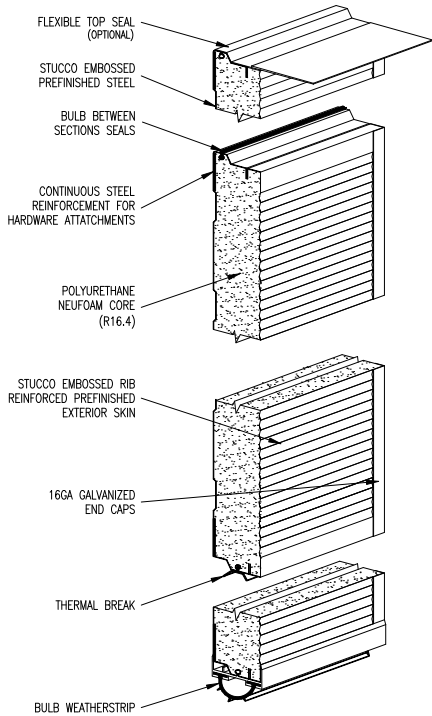
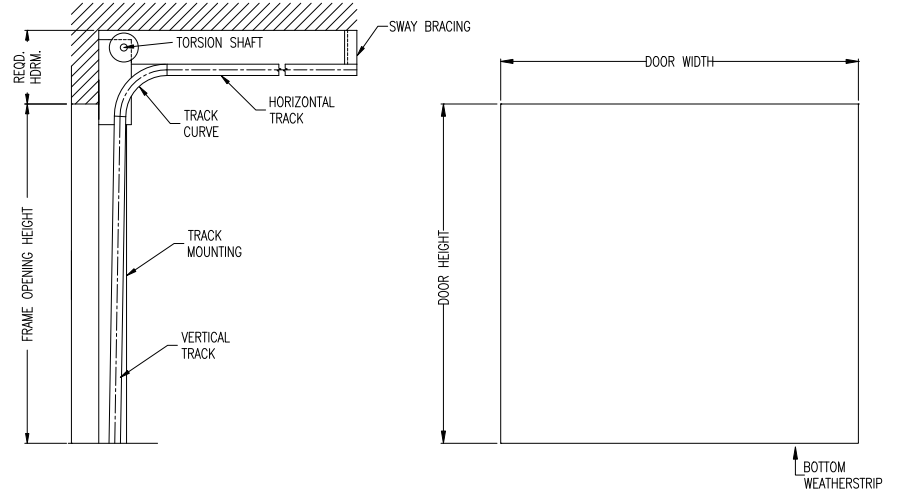

CROSS SECTION

EXTERIOR ELEVATION

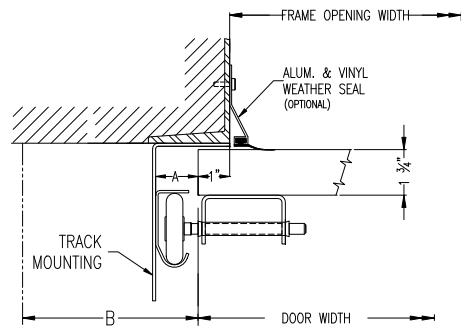

STEEL JAMB DETAILS

DOOR WIDTH		ADCA	A	B	C	TRUSSING	WIND LOAD
DOOR HEIGHT		2"	1 1/2"	3 1/2"	2 1/2"		
FRAME OPENING WIDTH		3"	2"	4"	3"	OPTIONS	
FRAME OPENING HEIGHT		VERTICAL TRACK					
HEADROOM REQ'D.		HORIZONTAL TRACK ___" RADIUS					
TRACK MOUNTING	<input type="checkbox"/> ADCA <input type="checkbox"/> BRACKET	LITES					

TITLE	THERMATITE T175-MR DOOR C/W ___" ROLLTITE STANDARD LIFT HARDWARE				
CLIENT					
SETS REQUIRED	TAG				
CLIENT'S ORDER NO.	R-W ORDER NO.				

Richards-Wilcox
CANADA INC.
TORONTO, ONTARIO

DRAWN			SCALE	NTS
CHECKED			DRAWING NO.	
APPROVED			SHEET NO.	