

DET.  $\frac{15}{6}$

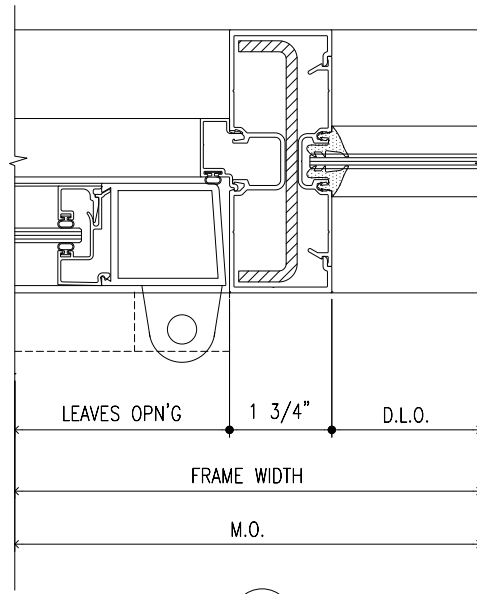

DET.  $\frac{16}{6}$

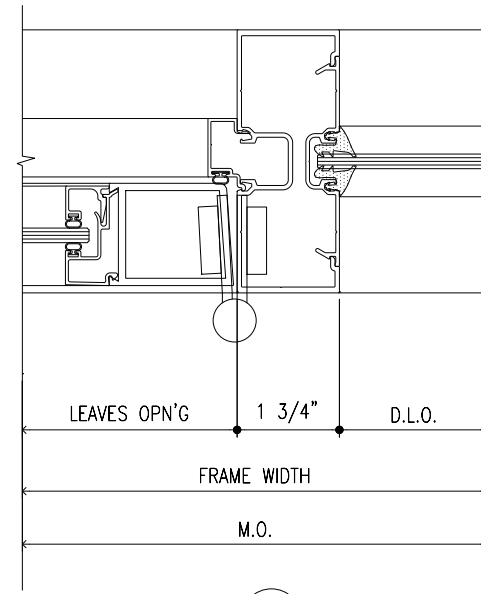

DET.  $\frac{17}{6}$

PROJECT NAME: IMPACT SYSTEM DETAILS: SMI-McKINLEY

APPRD.: A.M.	DRAW BY: L.C.	CHK BY: A.M.
REV. DATE:	DATE: JULY 19-07	DATE:
TEST REPORT NO.:	SERIE TEST: SMI-NON IMPACT SYSTEM	SCALE: 6" = 1'-0"
SHEET: 6 OF 6		



## SMI SYSTEMS WINDOW WALL + ENTRANCE

11305 NW. 128 STREET, MEDLEY, FLORIDA 33178  
PHONE: 305-888-6288 FAX: 305-888-6289