

1-TREAD

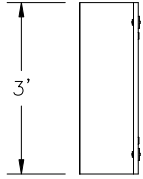

TOP VIEW

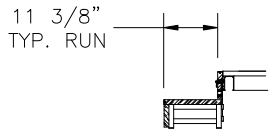

SIDE VIEW

2-TREAD

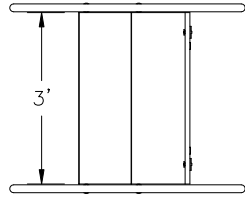

TOP VIEW

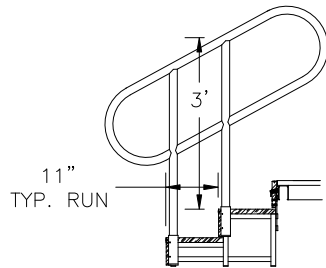

SIDE VIEW

3-TREAD

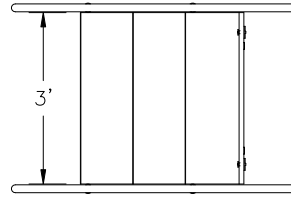

TOP VIEW

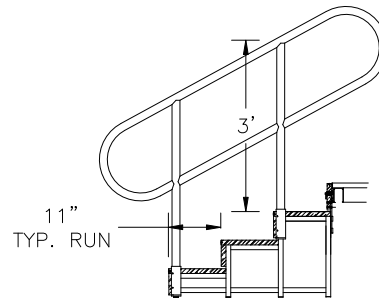

SIDE VIEW

4-TREAD

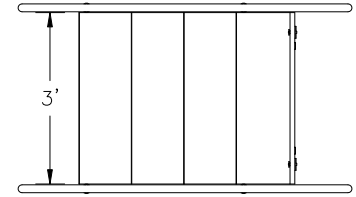

TOP VIEW

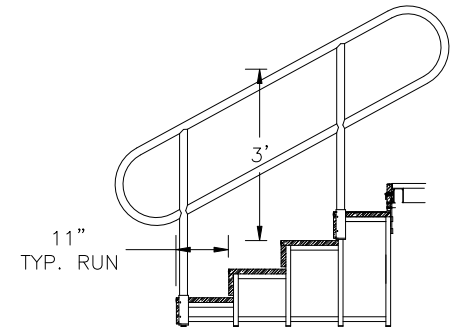

SIDE VIEW

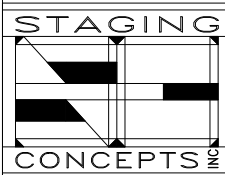

CORPORATE OFFICE
 7008 Northland Dr. Suite 150
 Brooklyn Park, Minnesota 55428
 PH: (763) 533-2094

MATERIAL

TITLE
**FIXED HEIGHT
 STAIR UNITS**

THIS DRAWING IS THE PROPERTY OF STAGING CONCEPTS, INC AND IS FURNISHED ON A CONFIDENTIAL BASIS. NEITHER THE DRAWING NOR ITEMS THEREON ARE TO BE REPRODUCED OR USED IN ANY MANNER NOT AUTHORIZED BY STAGING CONCEPTS AND IS LOANED SUBJECT TO RETURN ON DEMAND

ITEM	DATE	DESCRIPTION OF CHANGE	AUTH.
	DR. BY	DATE	PROJECT
	SCALE		PROJECT
	UNSPECIFIED TOLERANCES ARE TO BE		NUMBER
	LINEAR	ANGULAR	