

AOL FRAMING
(D-42 NESTED IN D-42)

INTERIOR

1 HEAD DETAIL
SCALE: FULL

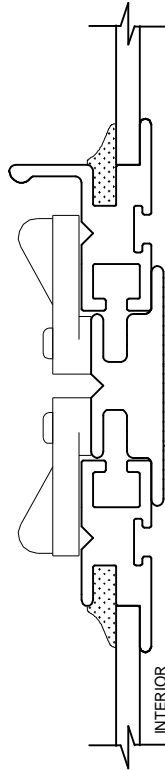

AOL FRAMING
(T-9)

INTERIOR

4 MUNTIN DETAIL
SCALE: FULL

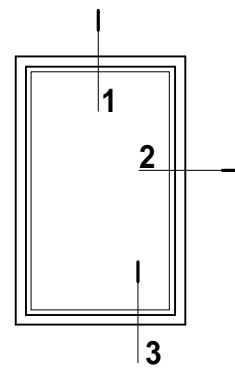

AOL-A

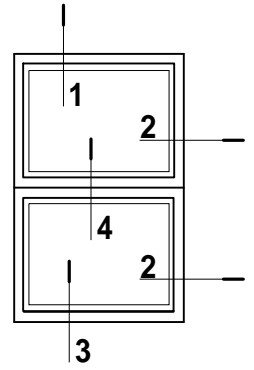

AOL-C

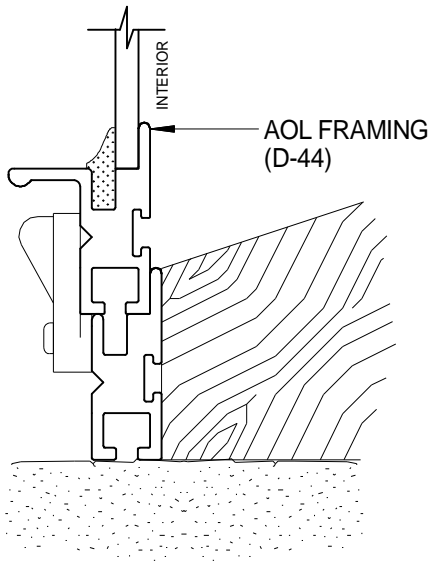

AOL FRAMING
(D-44)

INTERIOR

3 SILL DETAIL
SCALE: FULL

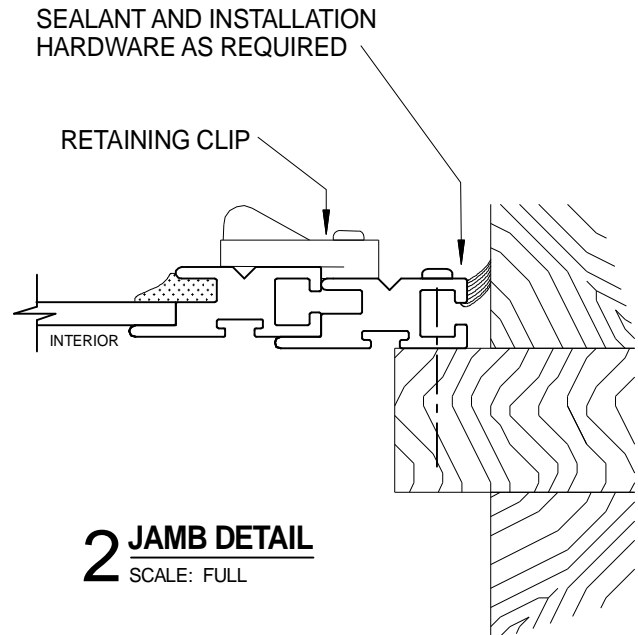

SEALANT AND INSTALLATION
HARDWARE AS REQUIRED

RETAINING CLIP

INTERIOR

2 JAMB DETAIL
SCALE: FULL

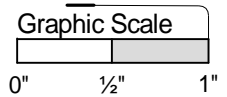

NOTE: INTERCHANGEABLE SCREEN AVAILABLE

PRODUCT
ALLIED ONE LITE • AOL-A and AOL-C
REMOVABLE PANELS

DWG. NO.

A-2

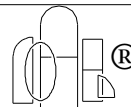

Allied Window
Performance Panels®

11111 CANAL ROAD • CINCINNATI, OH 45241 • PH: 800-445-5411, 513-559-1212 • FAX: 513-559-1883 • www.alliedwindow.com • info@alliedwindow.com