

3/4" H-MOLDING

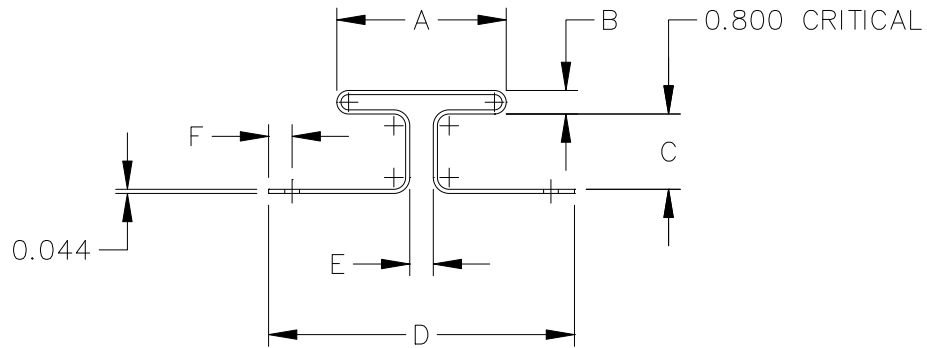

- A. FACE WIDTH = 1.800 ± 0.020
- B. EXPOSED BEAD WIDTH = 0.250 ± 0.010
- C. SIDING POCKET WIDTH = 0.800 ± 0.030
- D. TOTAL WIDTH = 3.000 ± 0.250
- E. HIDDEN GAP WIDTH = 0.000 TO 0.250
- F. NAIL SLOTS CENTER = $0.250 \pm .062$

WALL THICKNESS EXPOSED = $.044 \pm .035$
 WEIGHT PER FOOT - - - = .185 LBS.
 OVERALL LENGTH - - - = 12'-6"
 WARP - - - - - = .125"/PANEL
 WEEP HOLE - - - - - = N/A
 NAIL CENTER - - - - - = 16"

Alside®
 First On America's Homes