

REVISION HISTORY			
REV.	DESCRIPTION	DATE	APPROVED

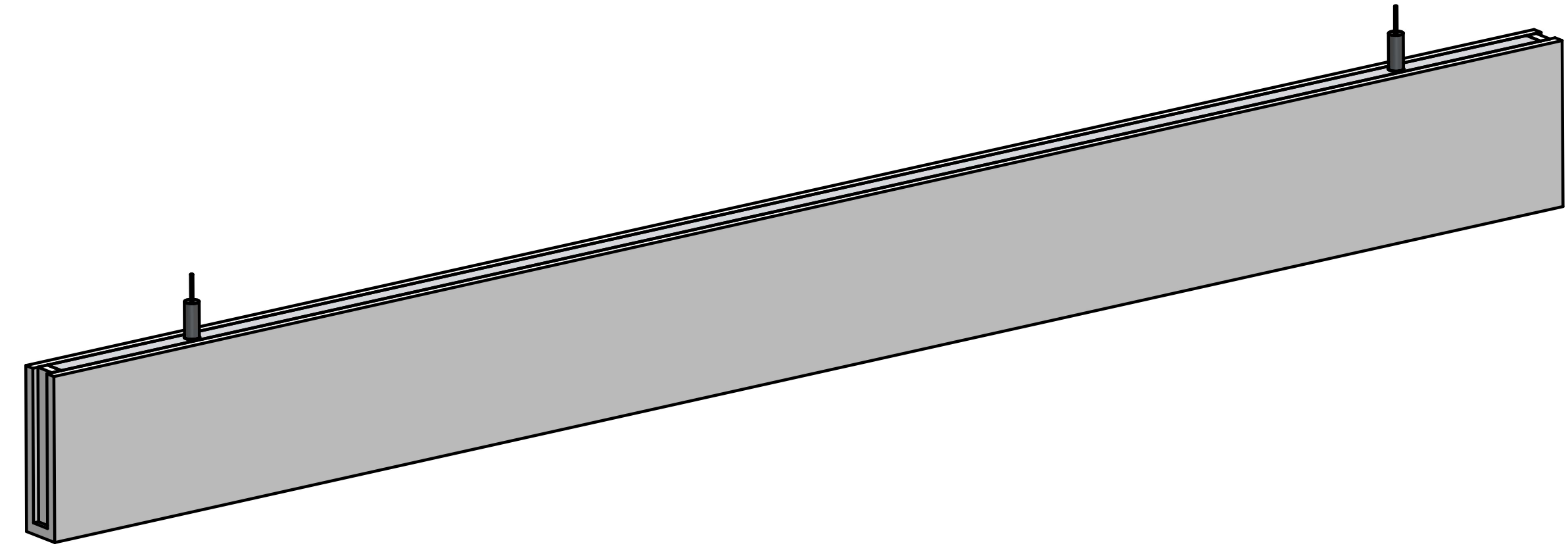

SECTION A-A

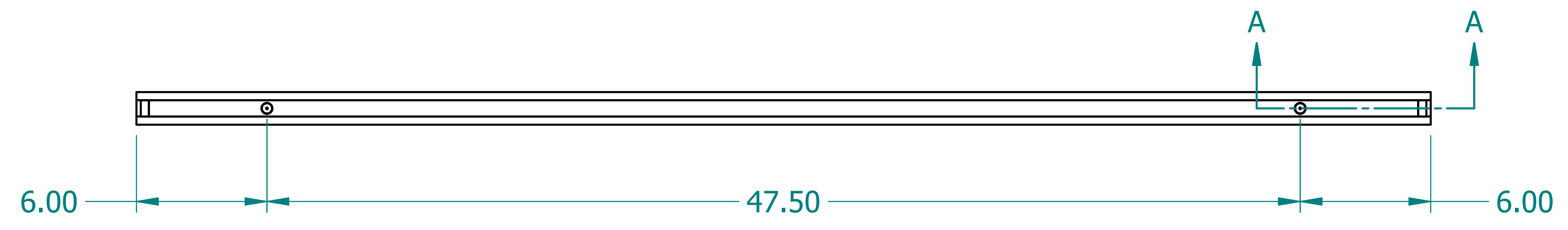
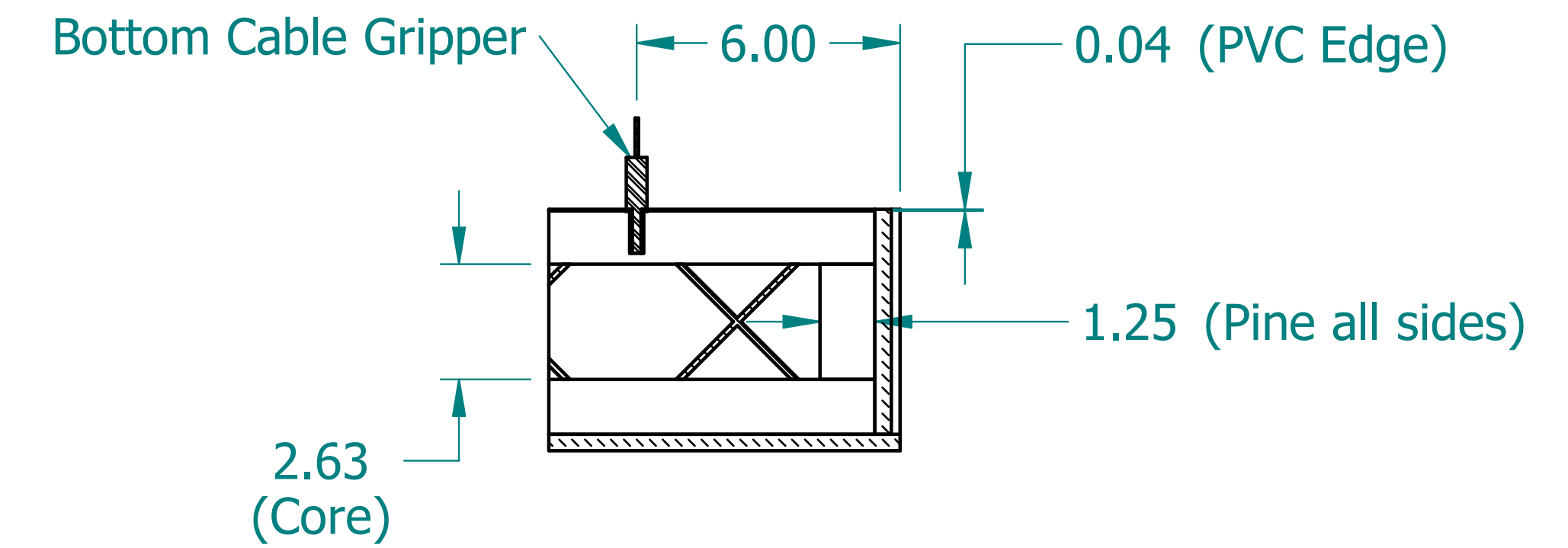

DETAIL B

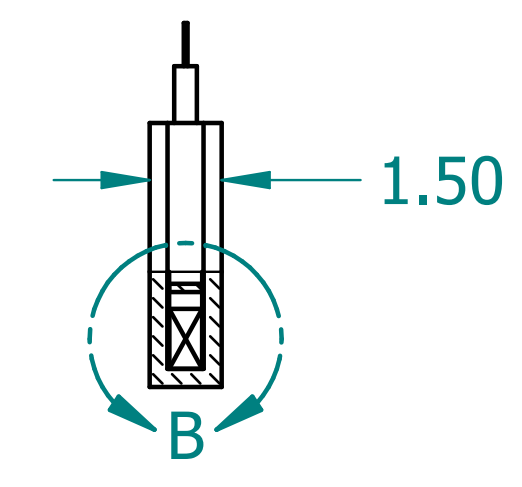
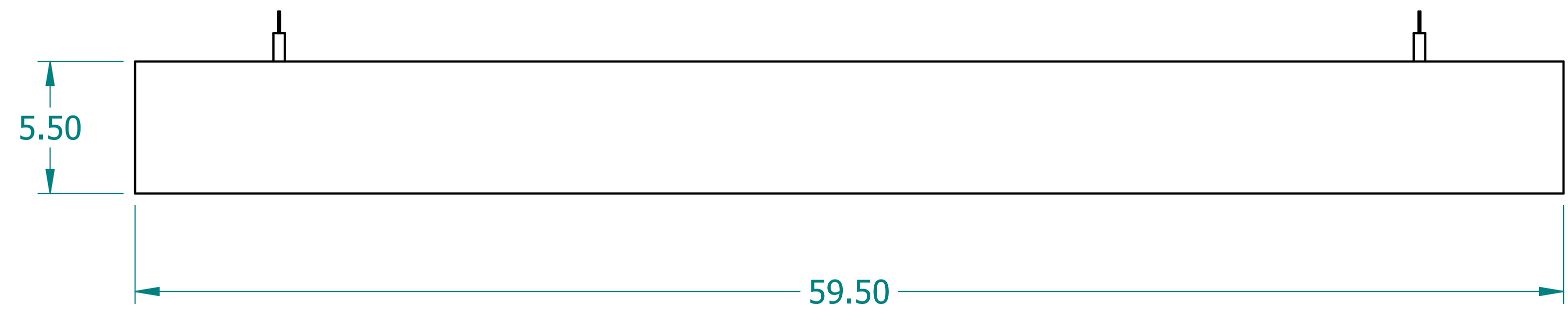
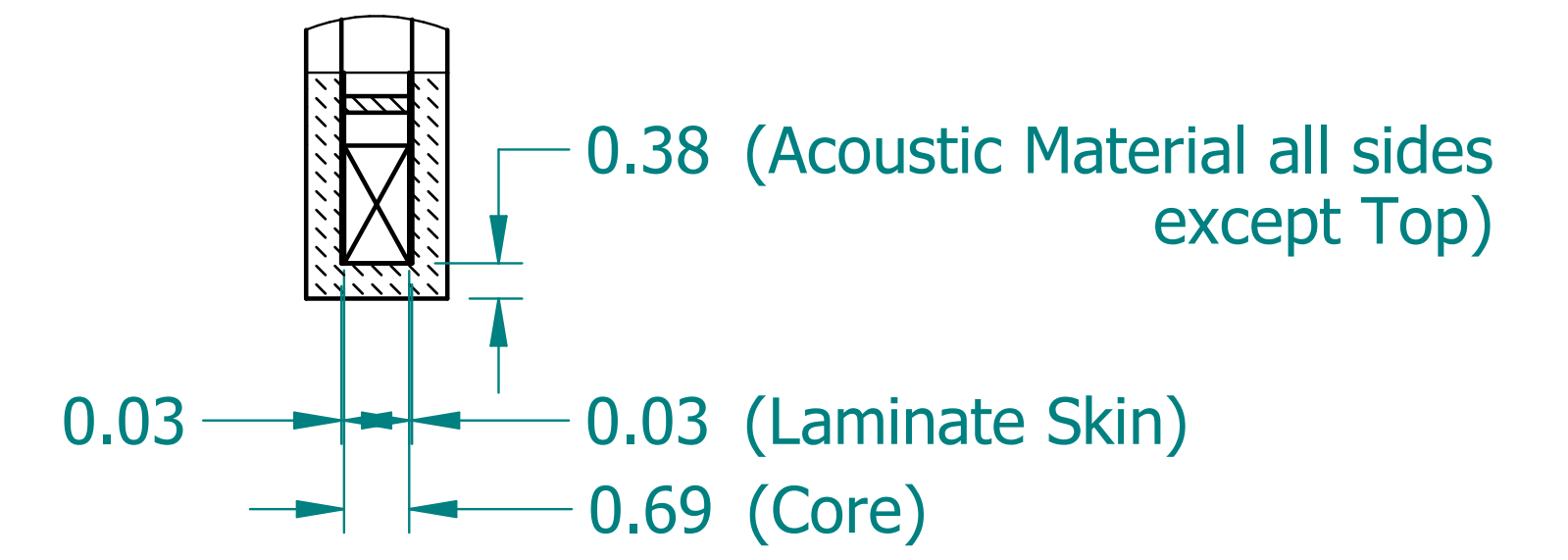

	NAME	DATE
DRAWN	SAI	03/11/20
ENG APPR	ERIC	03/11/20

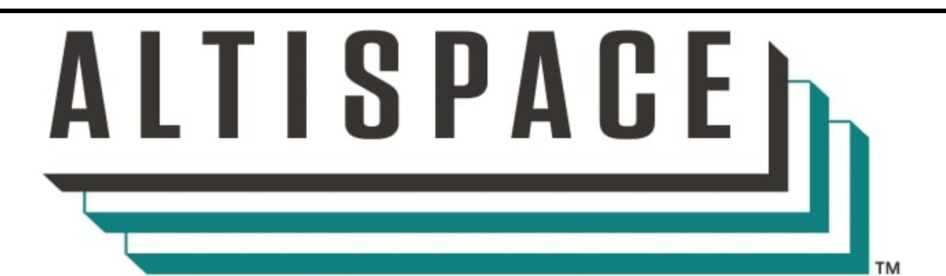

UNLESS OTHERWISE SPECIFIED DIMENSIONS ARE IN 'INCHES'  
 ANGLES  $\pm 0.8^\circ$  ; 2 PL  $\pm 0.040$  ;  
 3 PL  $\pm 0.020$

TITLE		Acoustic Blade	
SUBTITLE		60"x6"x1.5"	
PART NO:	ABlade-025-XX	REV.	1.0
SIZE: 34"x22"	SCALE: 0.25	SHEET 1 OF 1	
FILE NAME: Acoustic Blade (60.6.1.5).dft			