

REVISION HISTORY			
REV.	DESCRIPTION	DATE	APPROVED

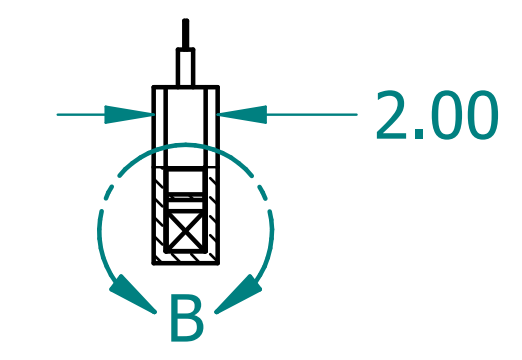

SECTION A-A

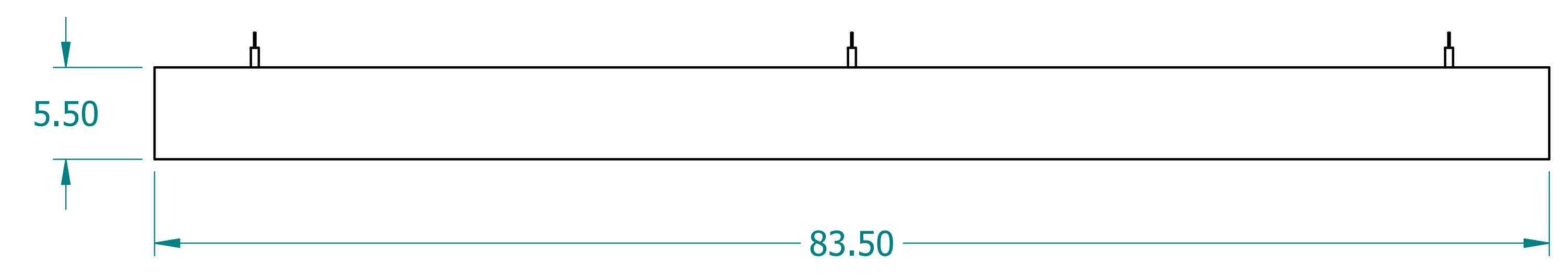
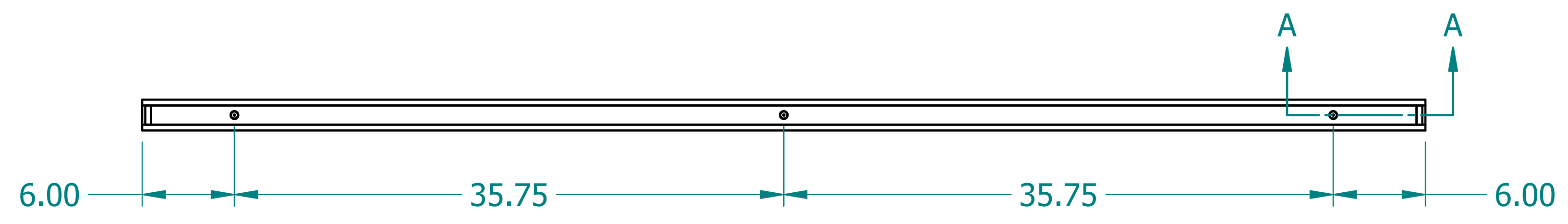
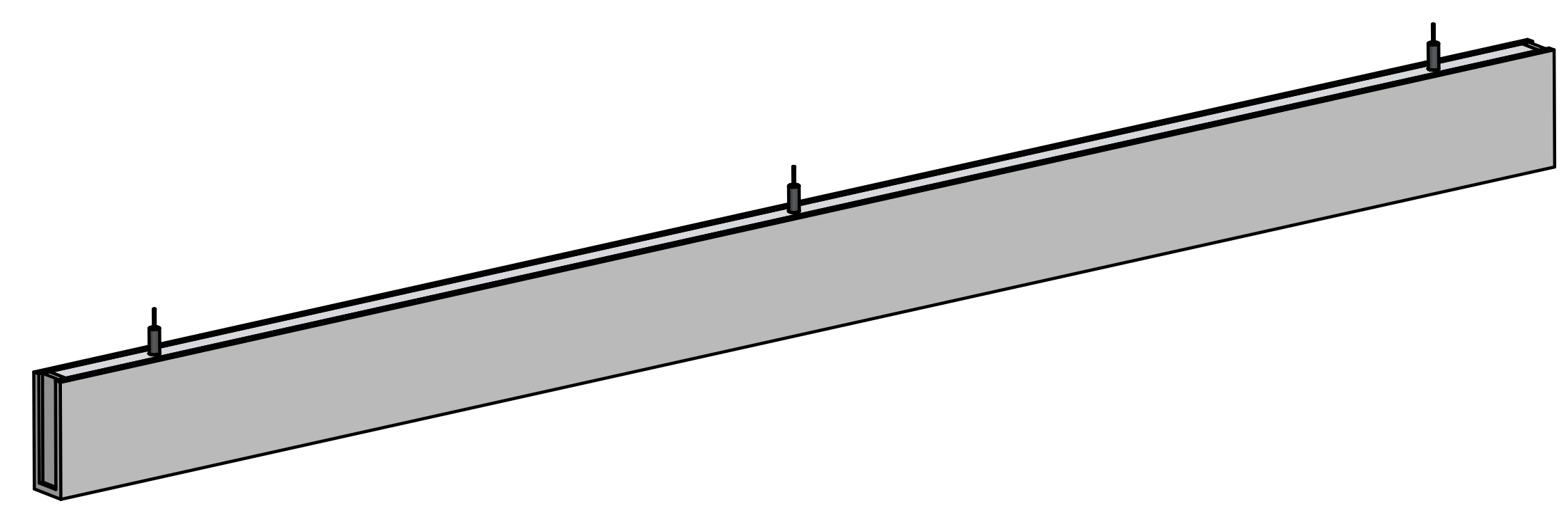
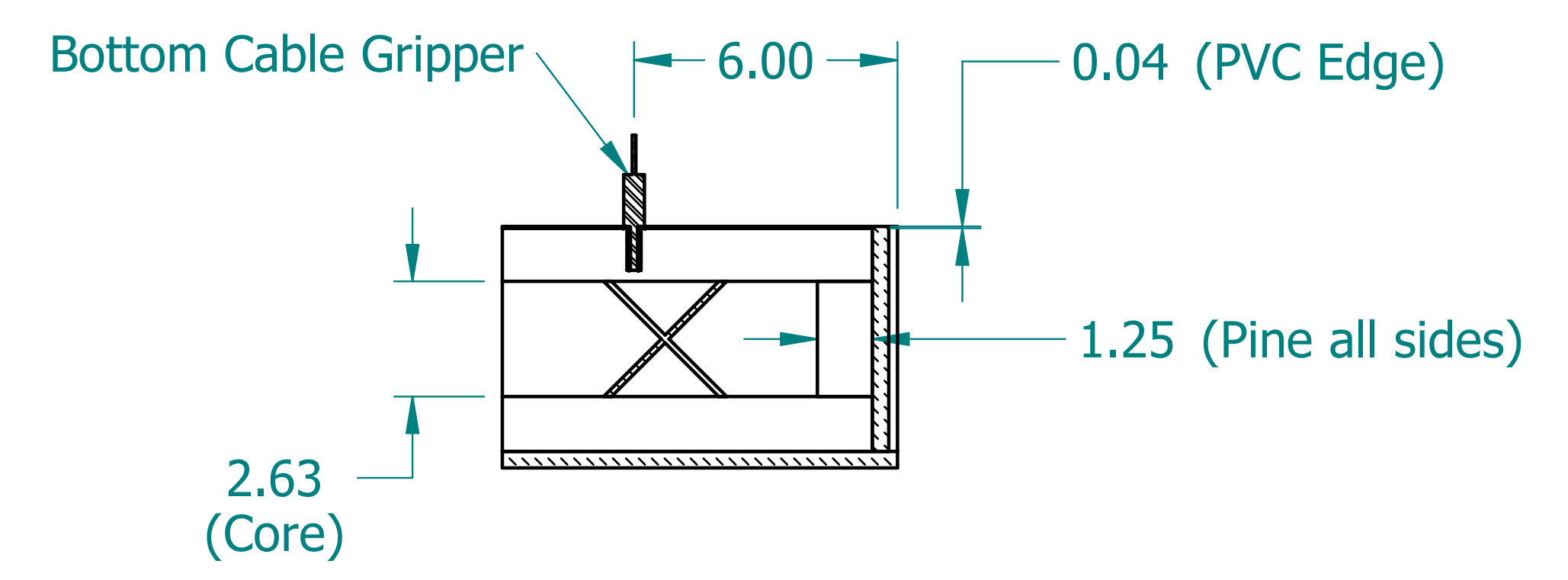

DETAIL B

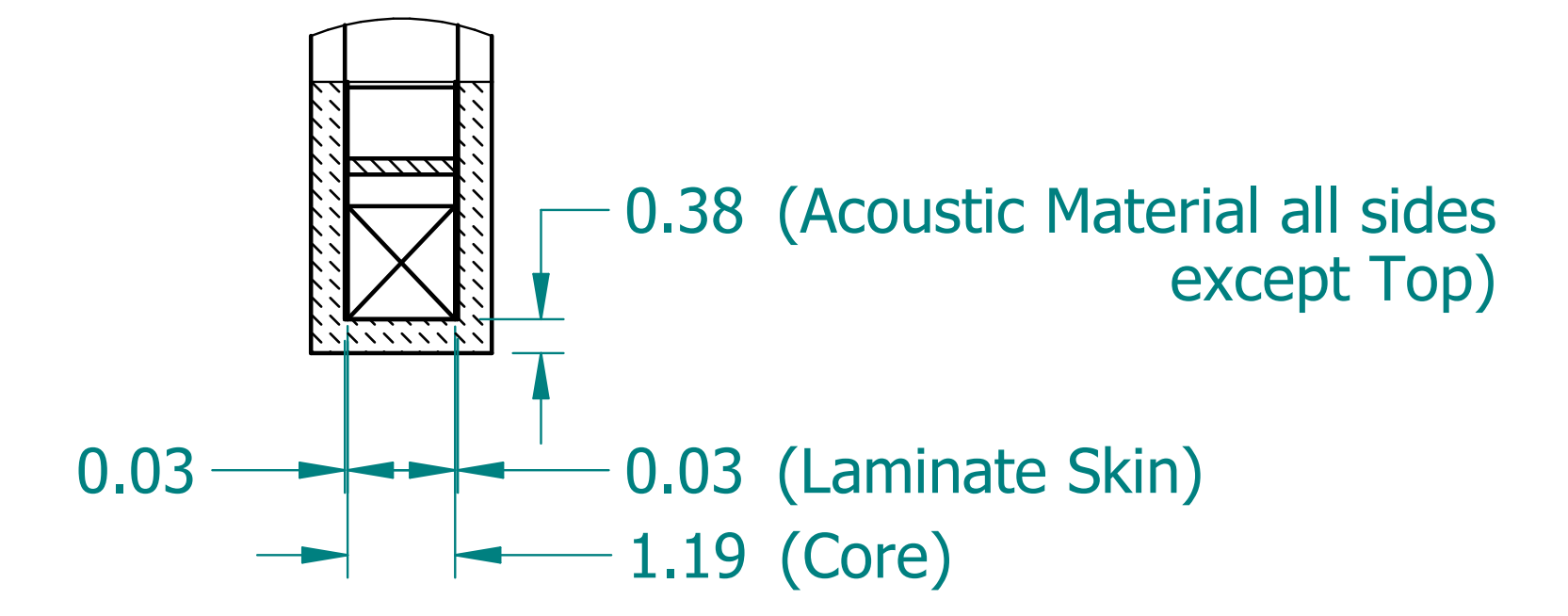

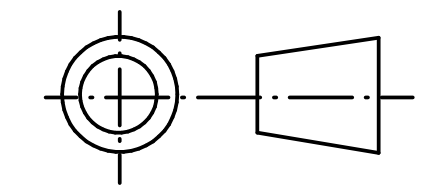
NAME	DATE	
DRAWN: SAI	03/11/20	
ENG APPR: ERIC	03/11/20	
 <p>UNLESS OTHERWISE SPECIFIED DIMENSIONS ARE IN 'INCHES'</p> <p>ANGLES ±0.8° ; 2 PL ±0.040 ; 3 PL ±0.020</p>		<p>TITLE: Acoustic Blade</p> <p>SUBTITLE: 84"x6"x2"</p> <p>PART NO: ABlade-045-XX REV: 1.0</p> <p>SIZE: 34"x22" SCALE: 0.17 SHEET 1 OF 1</p> <p>FILE NAME: Acoustic Blade (84.6.2).dft</p>