

REVISION HISTORY			
REV.	DESCRIPTION	DATE	APPROVED

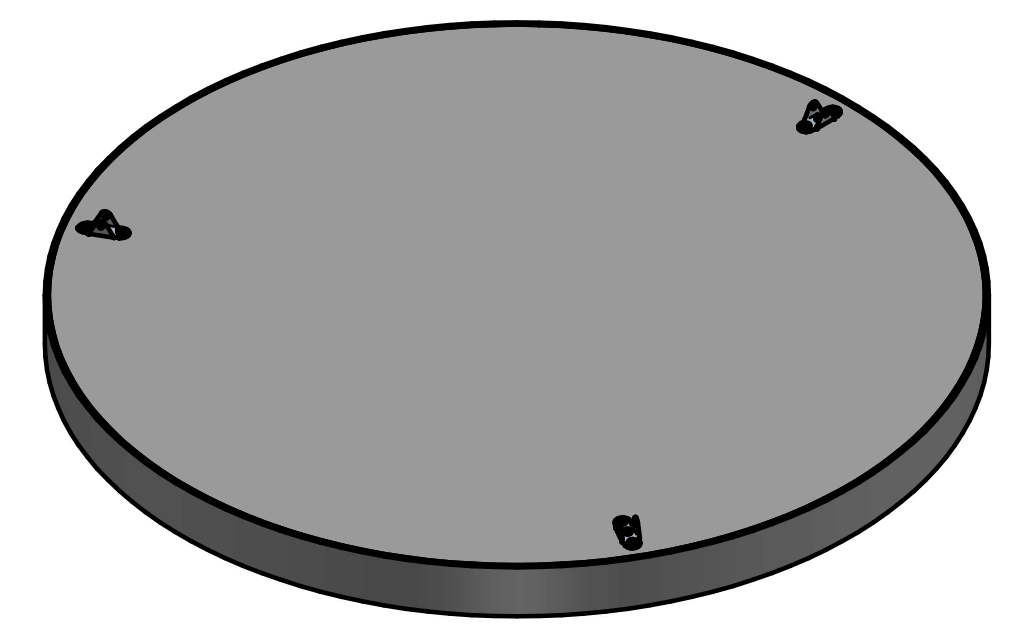

SECTION A-A

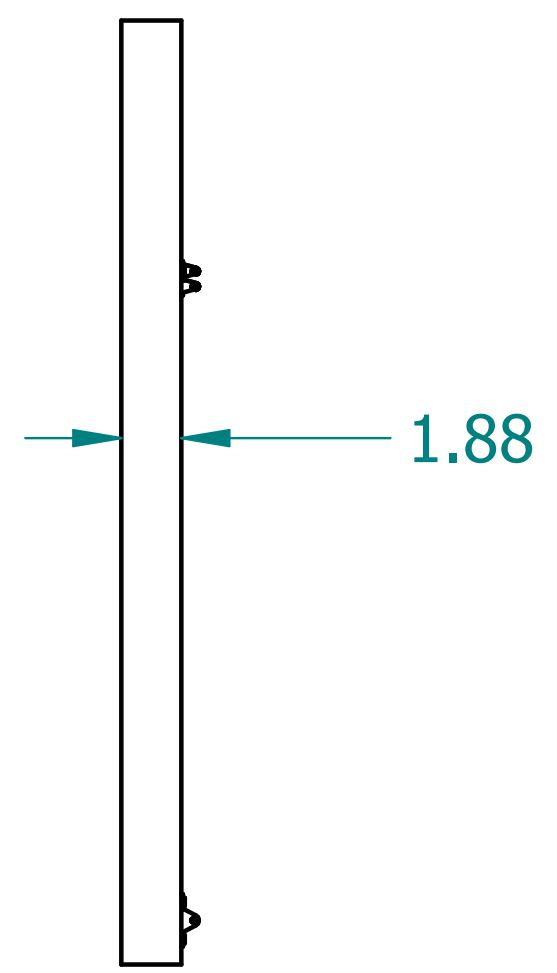
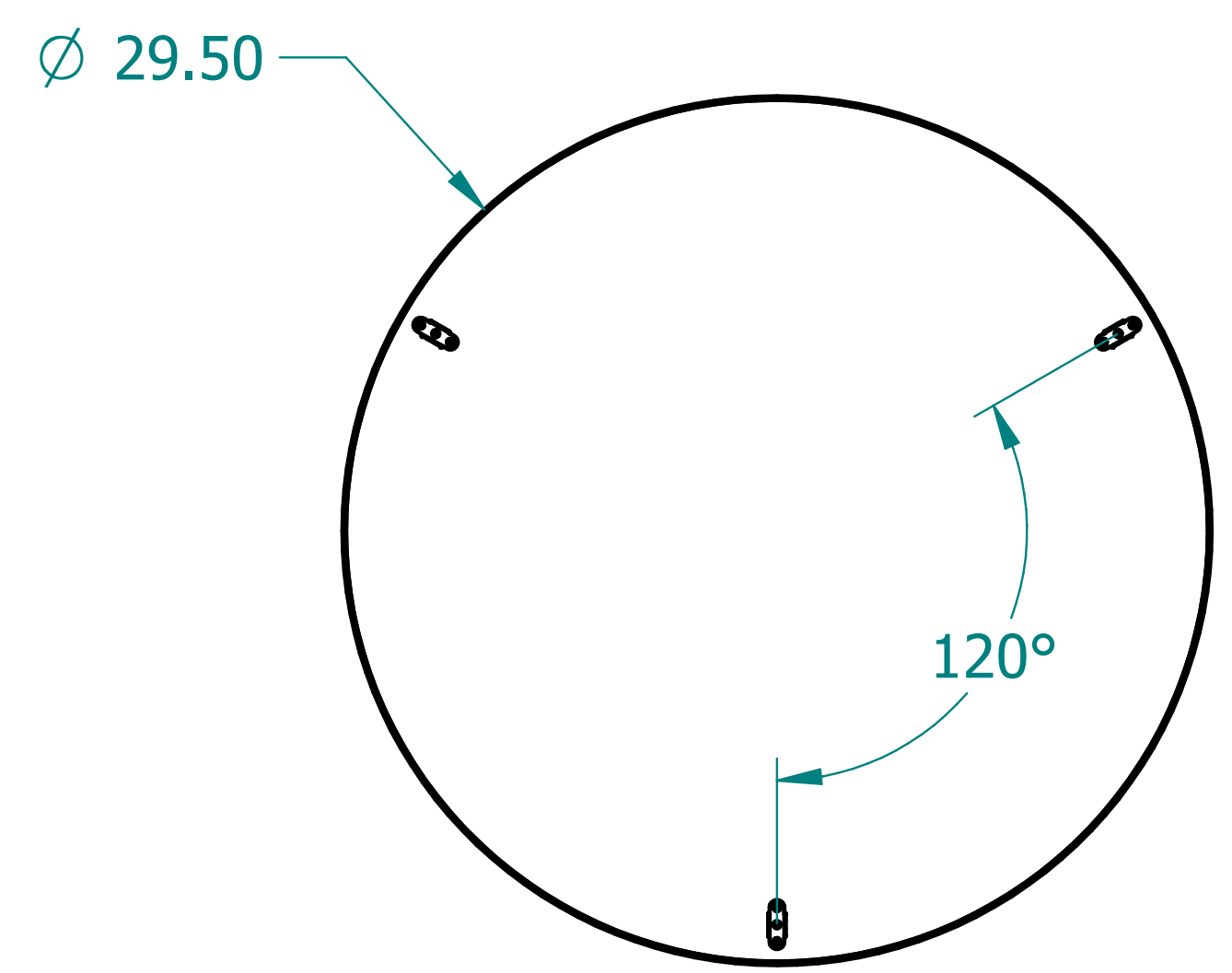
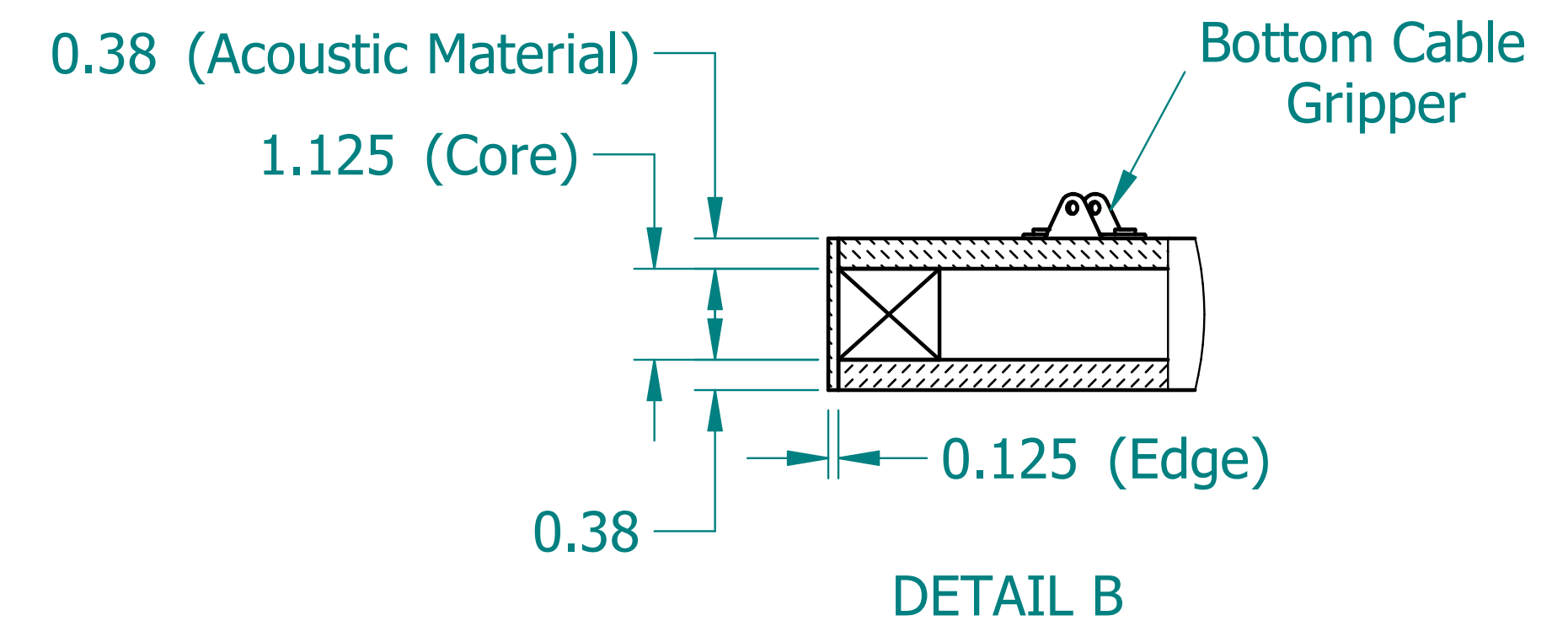
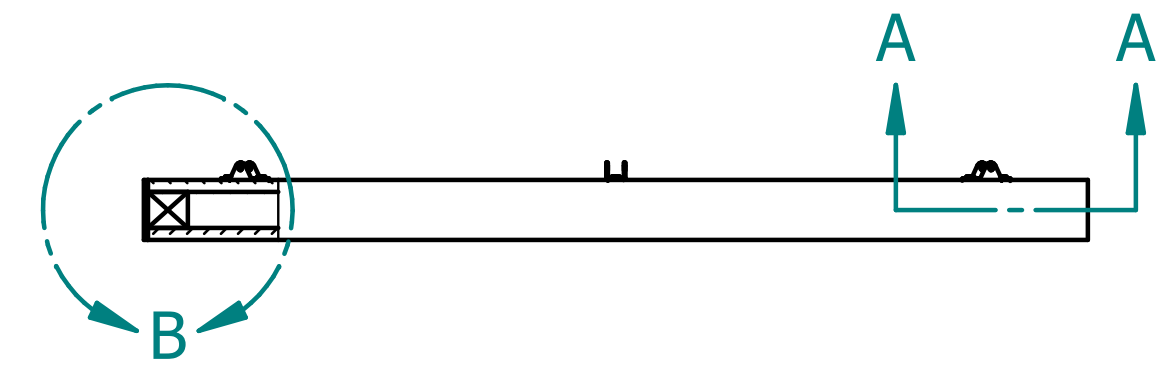
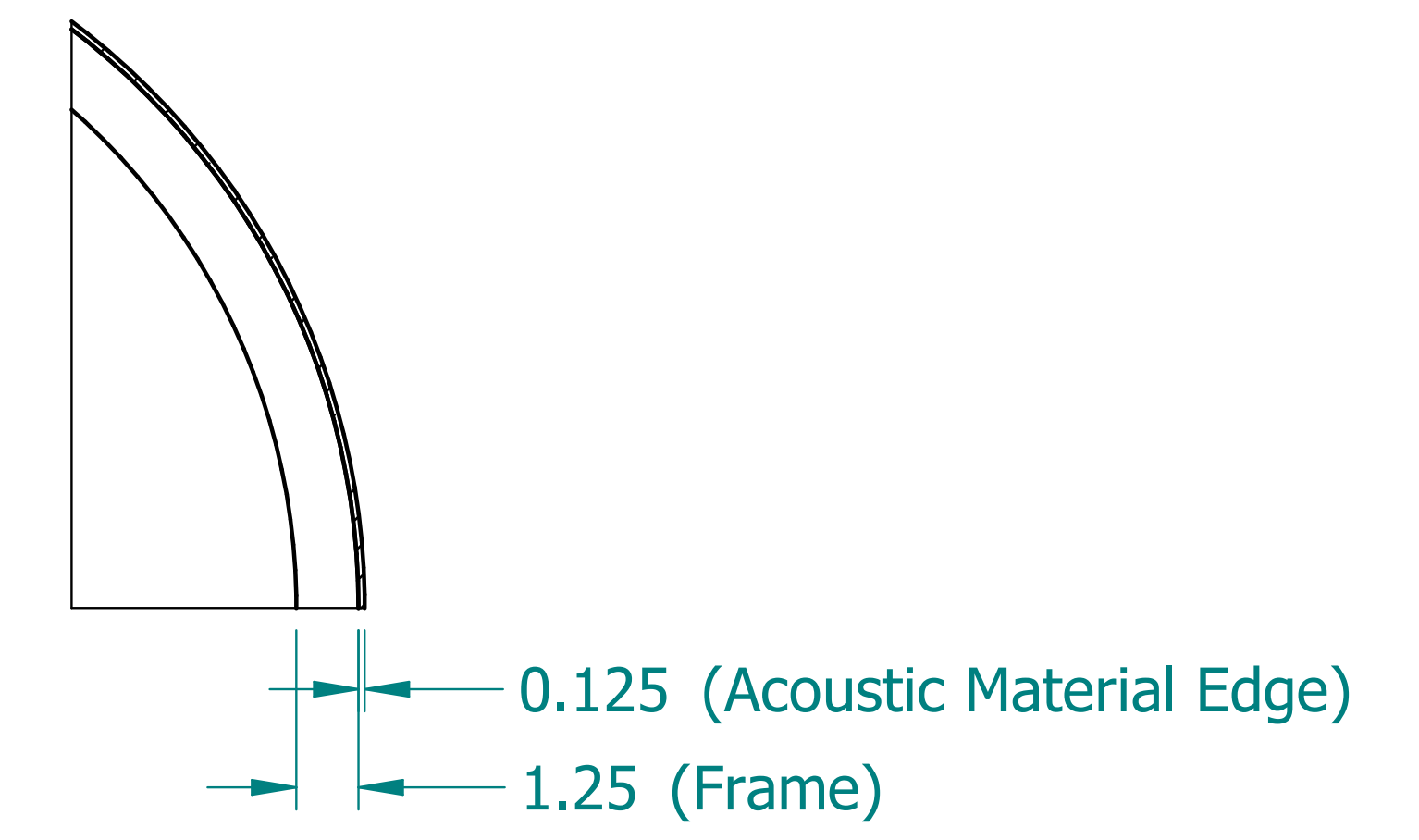

	NAME	DATE
DRAWN	SAI	04/27/20
ENG APPR	ERIC	04/27/20



UNLESS OTHERWISE SPECIFIED DIMENSIONS ARE IN 'INCHES'
ANGLES ±0.8° ; 2 PL ±0.040 ; 3 PL ±0.020

TITLE Acoustic Shape: Circle		
SUBTITLE 30"x30"x2"		
PART NO: AShape-2-02-XX	REV. 1.0	
SIZE: 34"x22"	SCALE: 0.17	SHEET 1 OF 1
FILE NAME: Acoustic Circle (30.30.2).dft		