

REVISION HISTORY			
REV.	DESCRIPTION	DATE	APPROVED

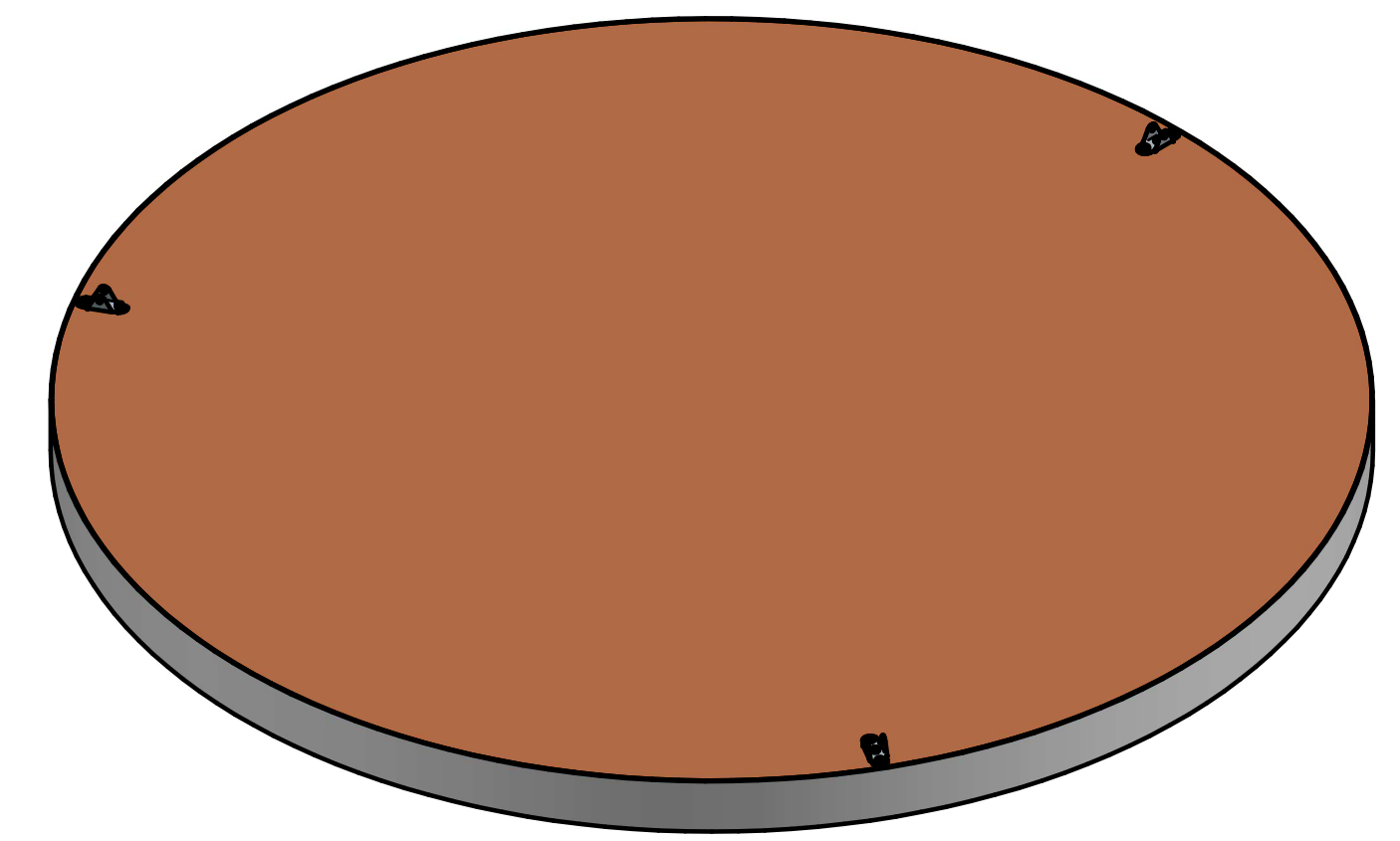

SECTION A-A

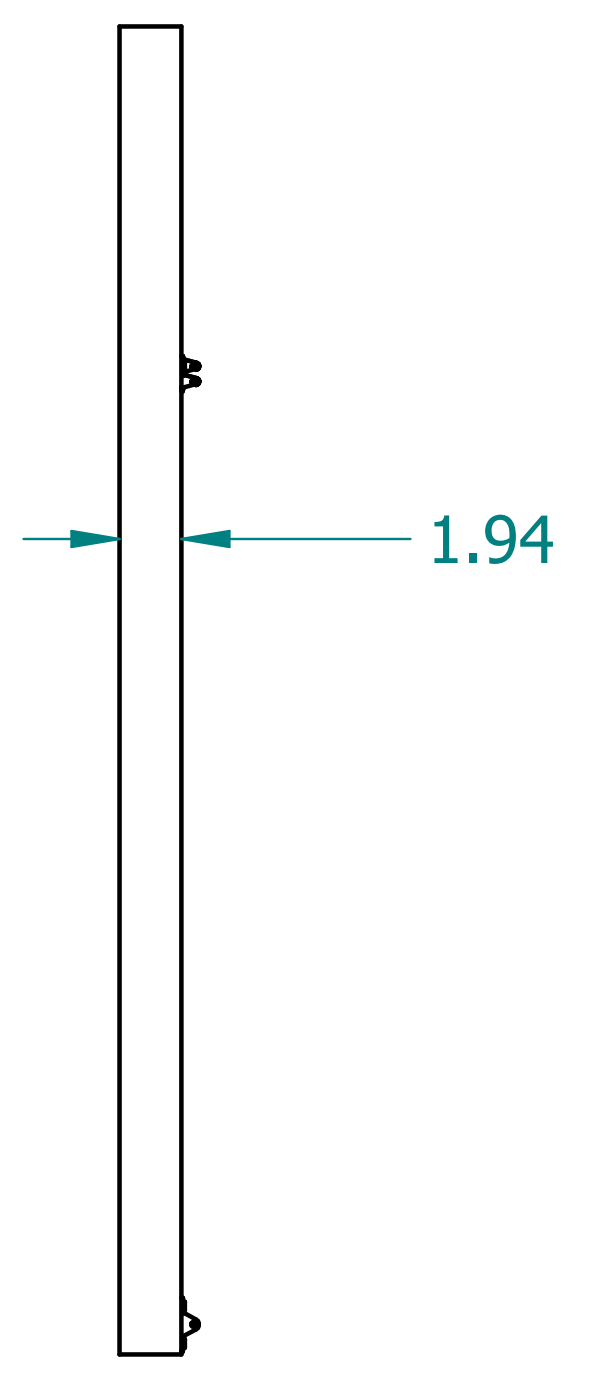
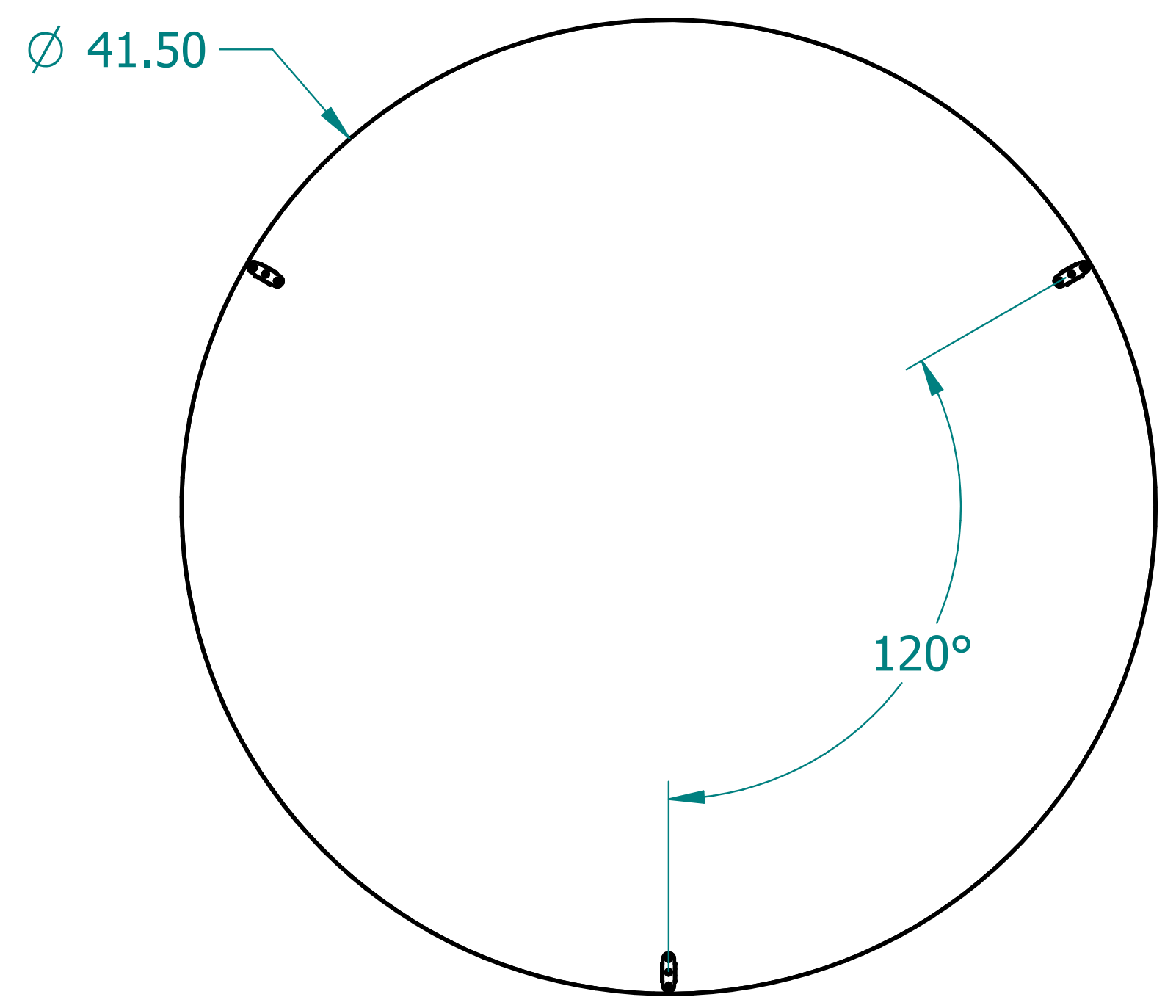
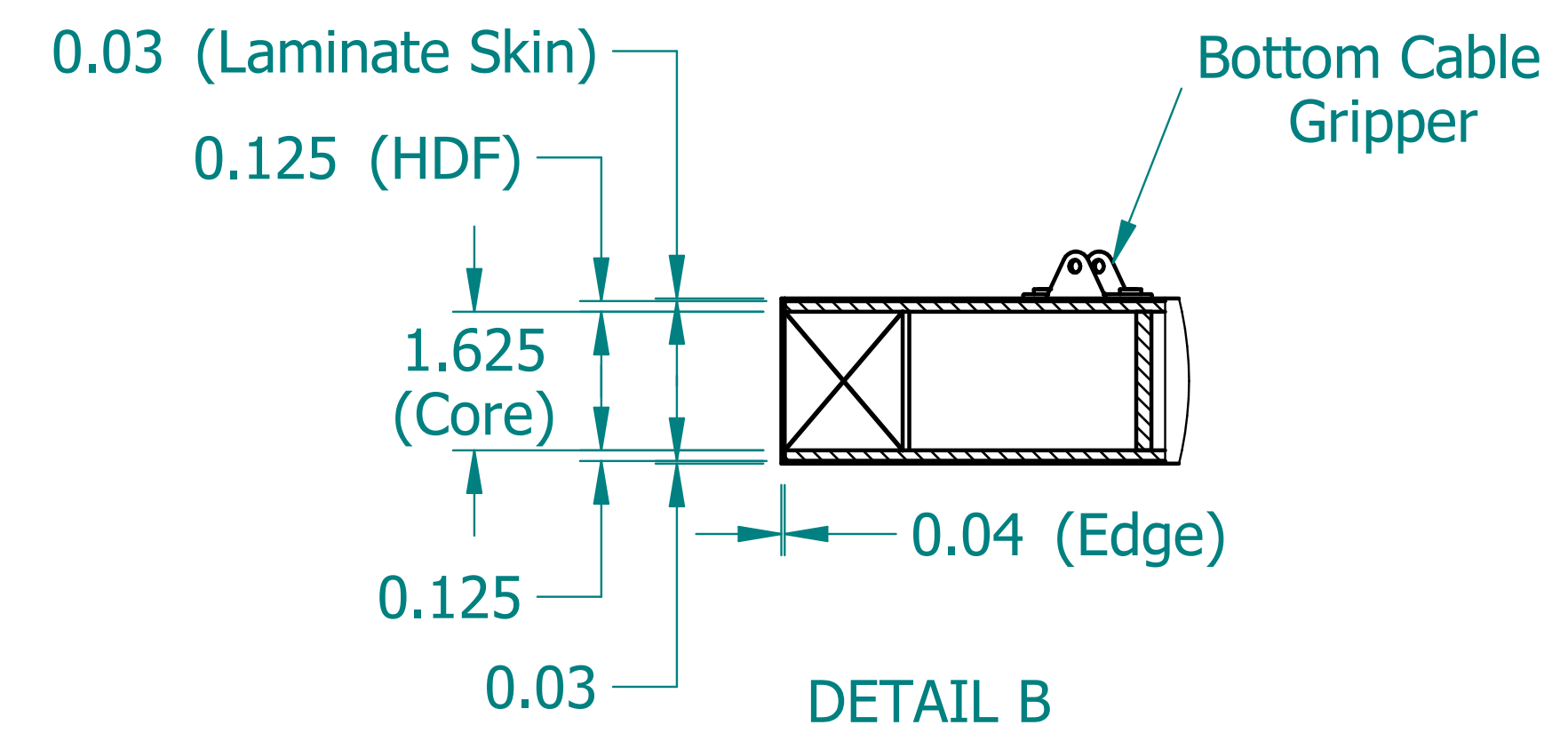
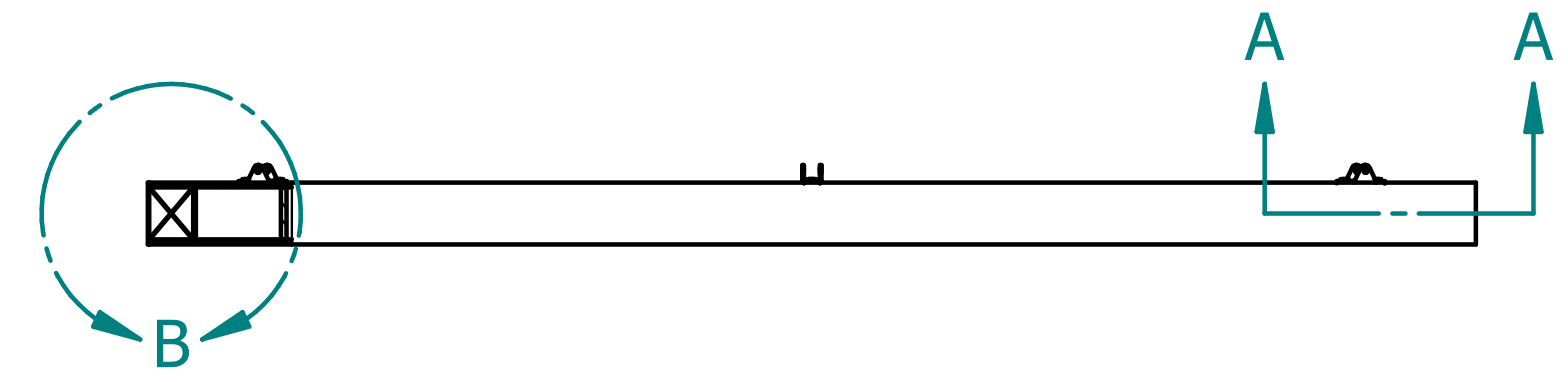
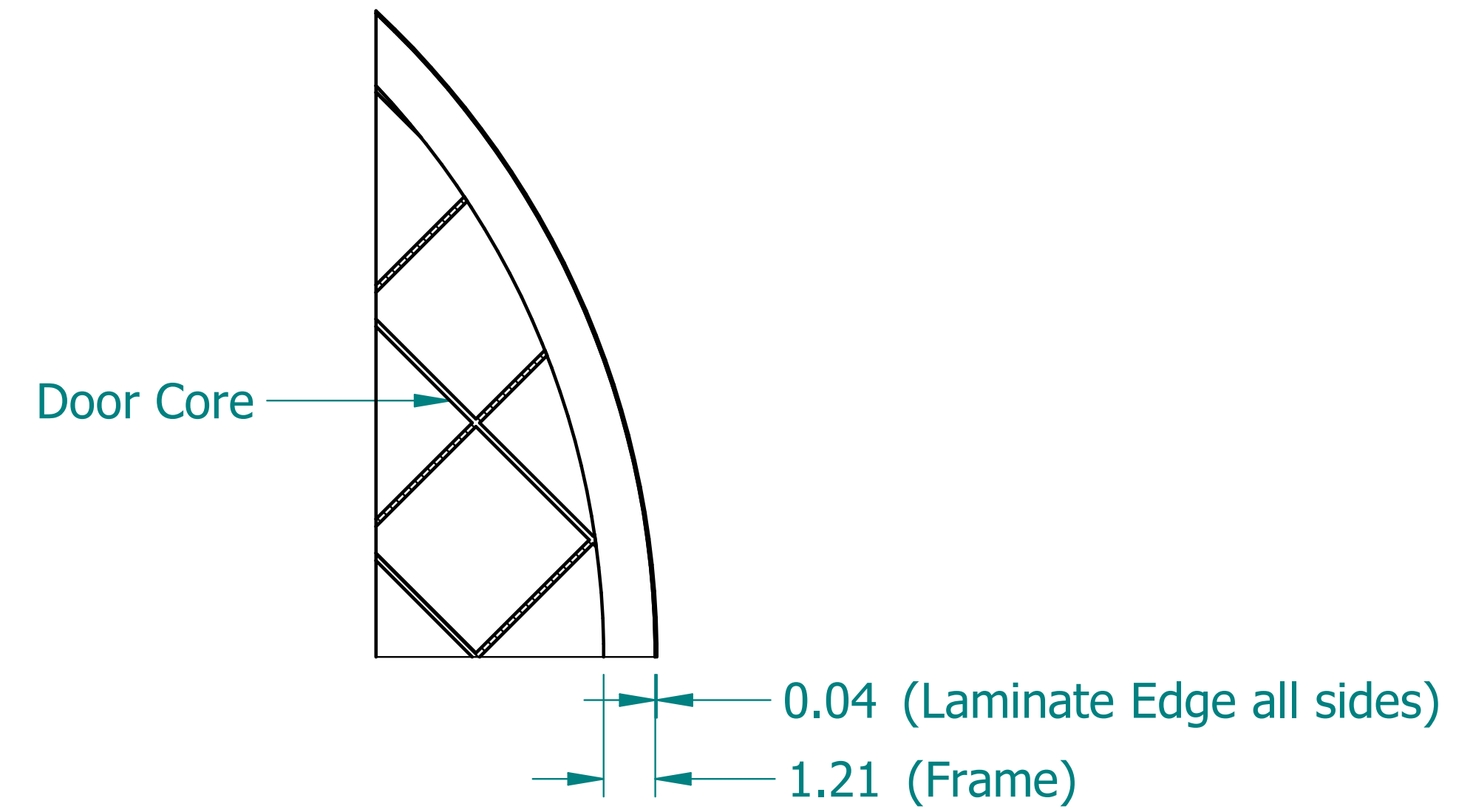

	NAME	DATE
DRAWN	SAI	04/27/20
ENG APPR	ERIC	04/27/20



UNLESS OTHERWISE SPECIFIED DIMENSIONS ARE IN 'INCHES'
 ANGLES ±0.8° ; 2 PL ±0.040 ;
 3 PL ±0.020

TITLE Laminate Shape: Circle		
SUBTITLE 42"x42"x2"		
PART NO: Shape-2-04-XX	REV. 1.0	
SIZE: 34"x22"	SCALE: 0.17	SHEET 1 OF 1
FILE NAME: Laminated Circle (42.42.2).dft		