

REVISION HISTORY			
REV.	DESCRIPTION	DATE	APPROVED

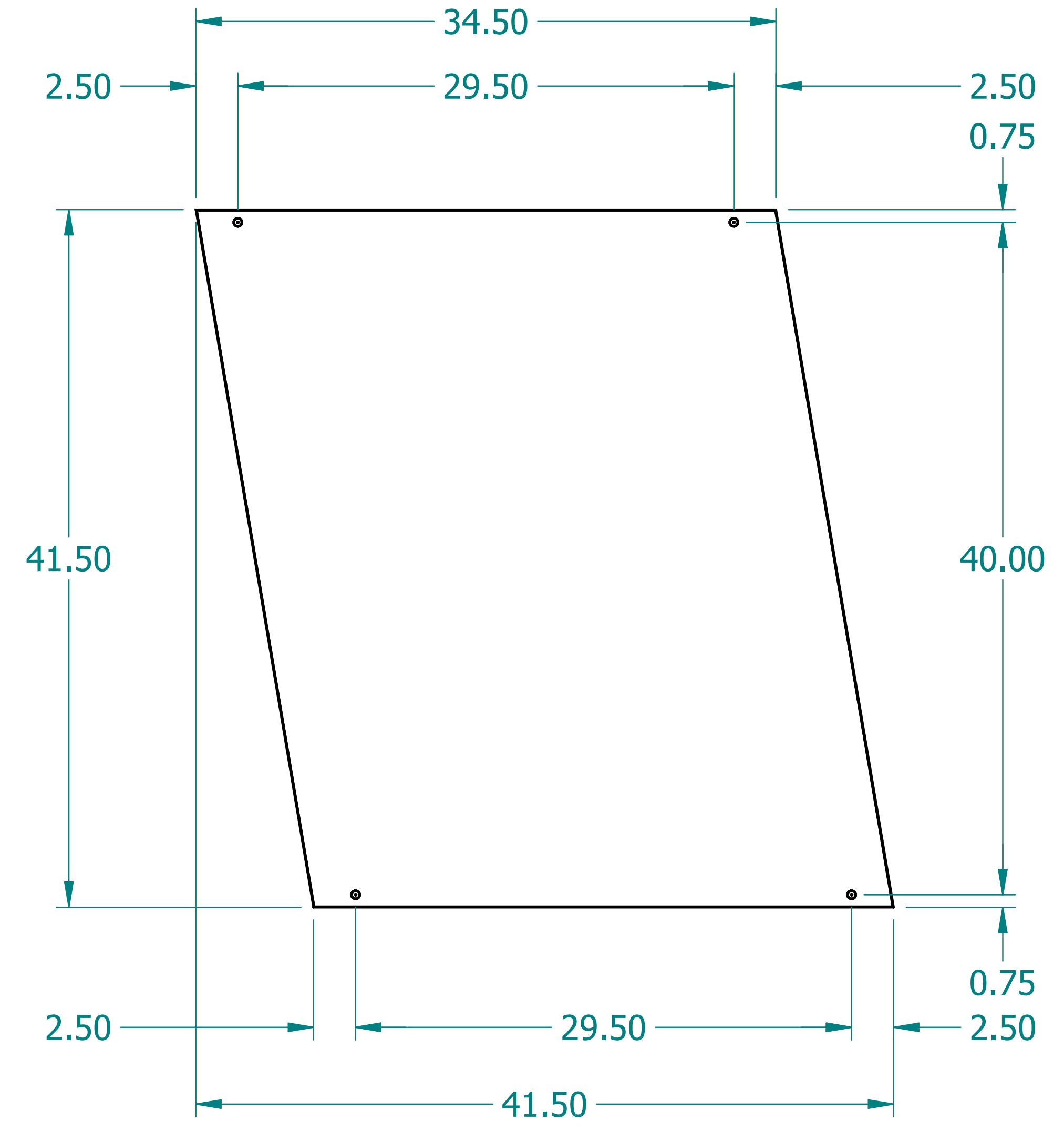

SECTION A-A

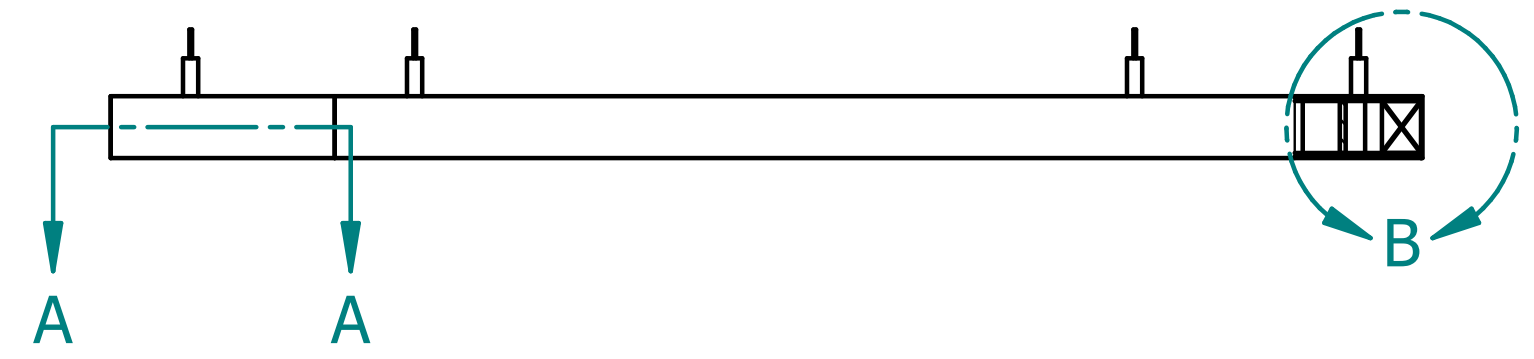
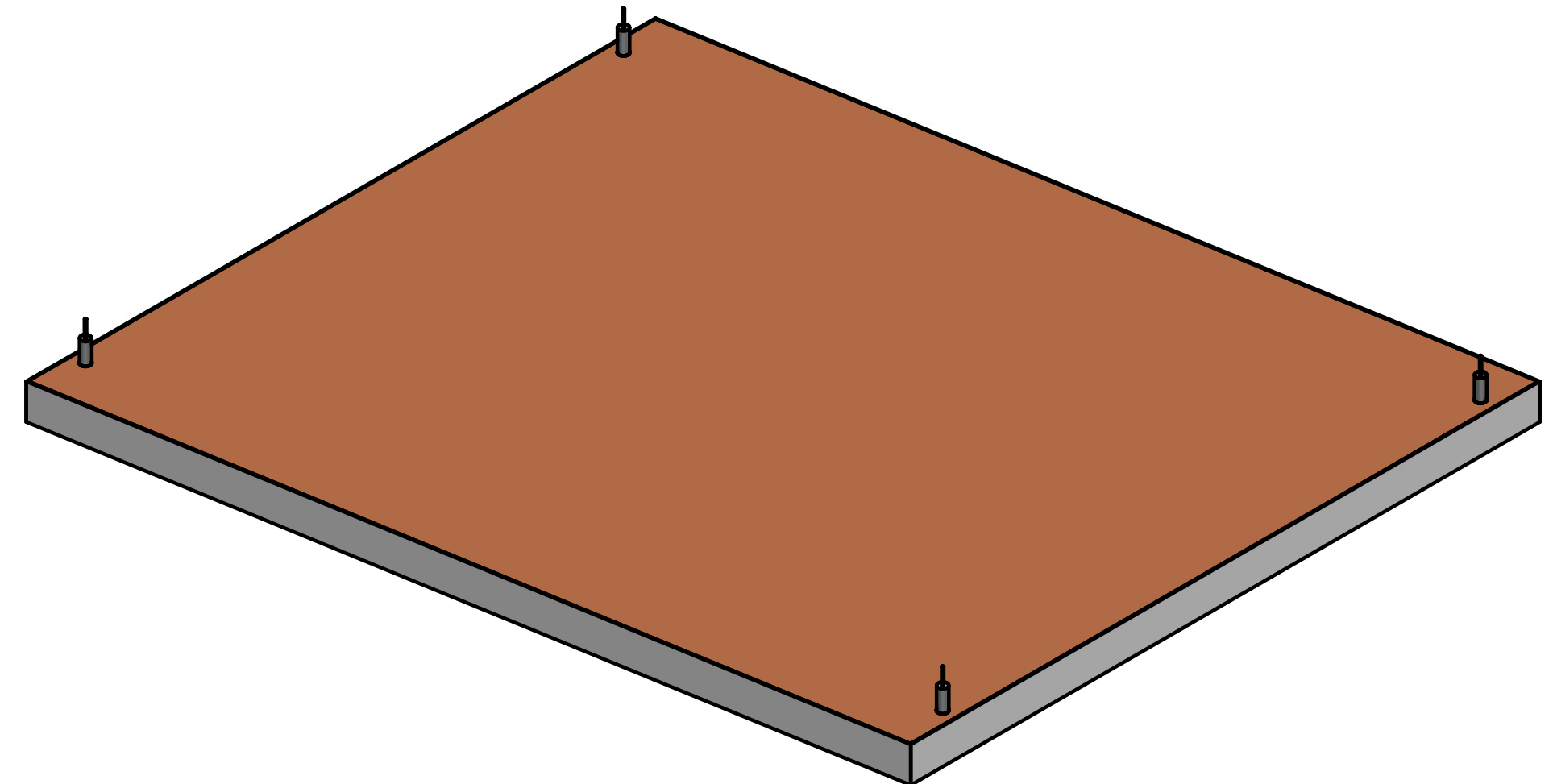
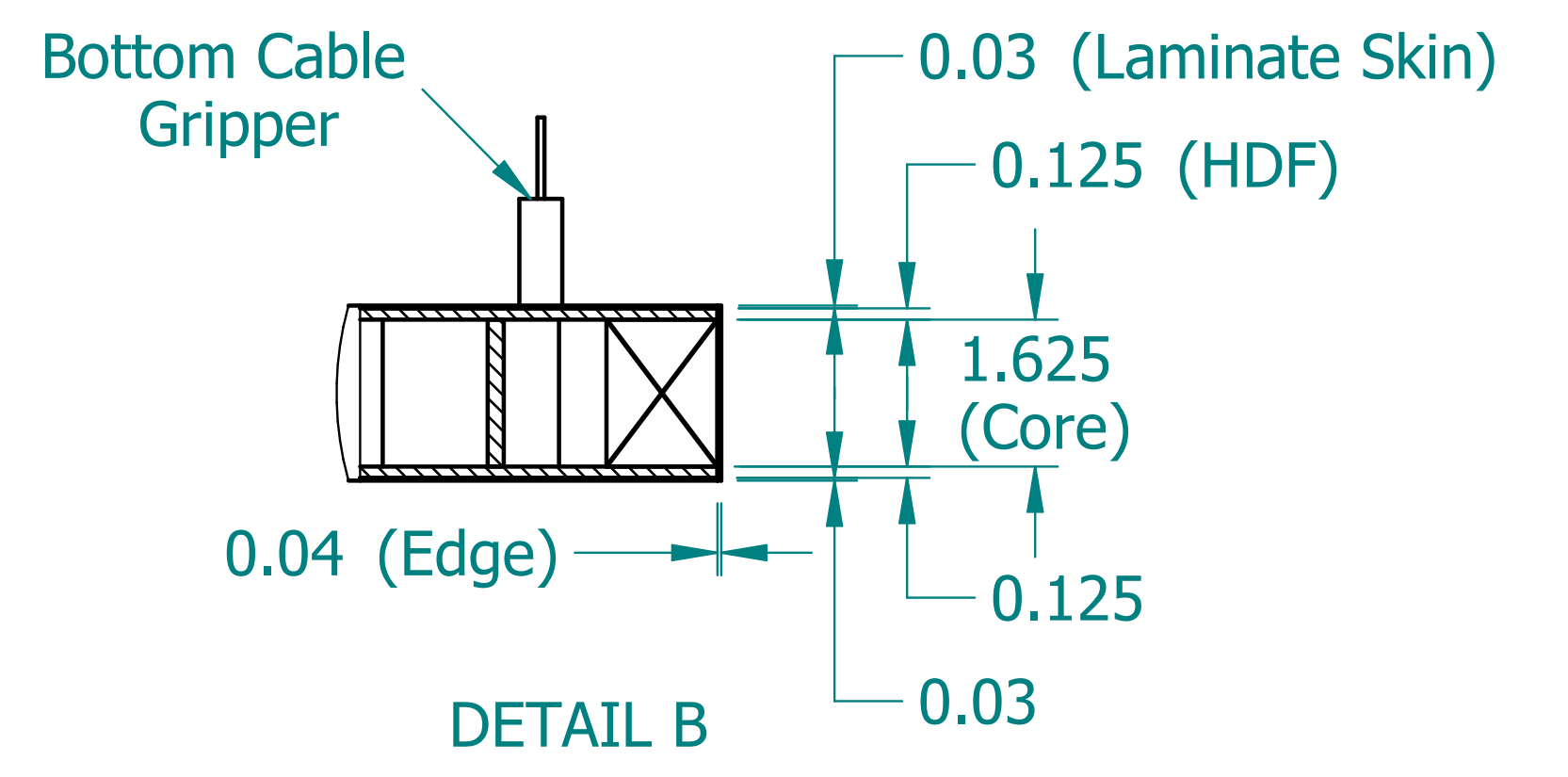
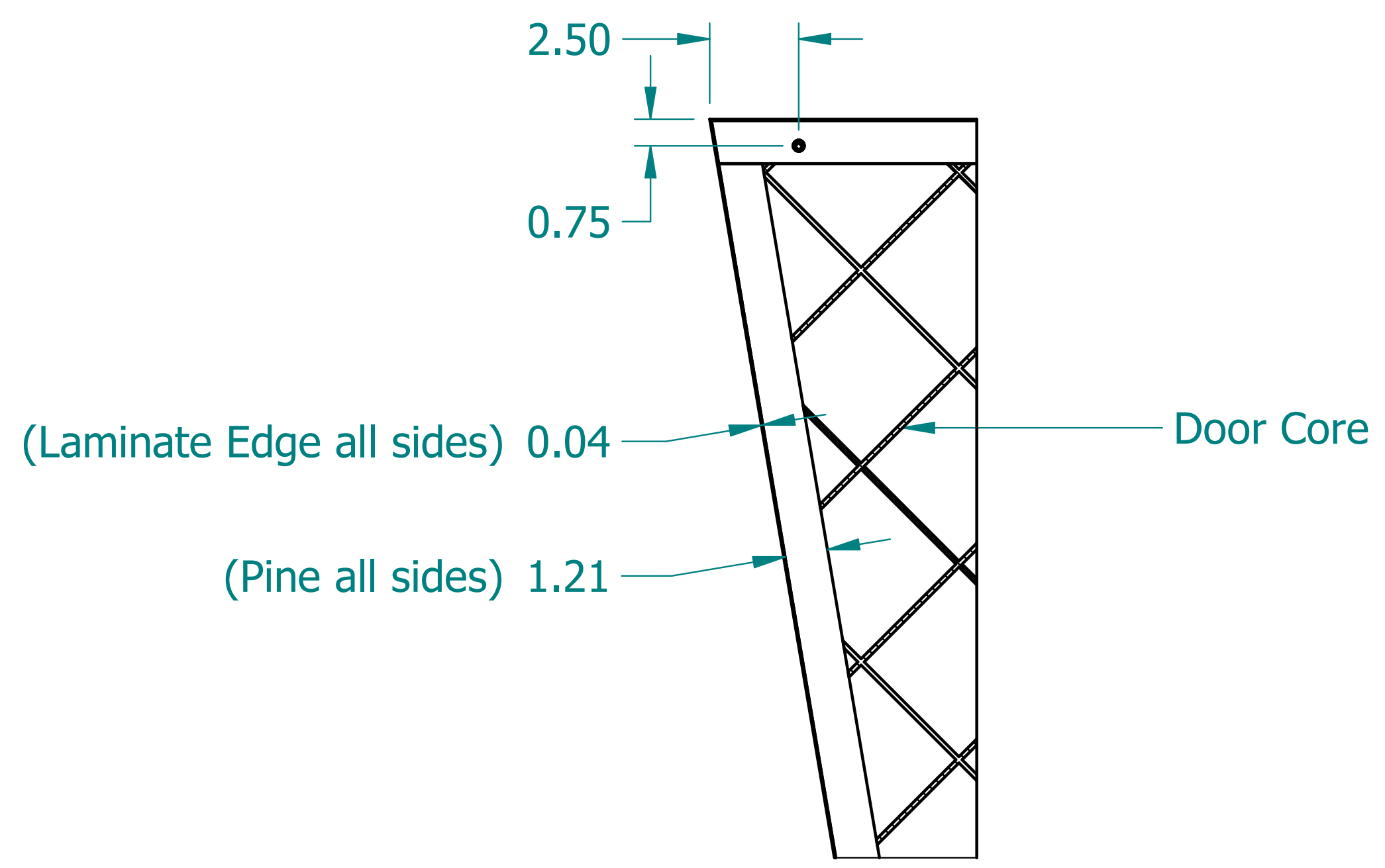

	NAME	DATE
DRAWN	SAI	05/05/20
ENG APPR	ERIC	05/05/20



UNLESS OTHERWISE SPECIFIED DIMENSIONS ARE IN 'INCHES'
 ANGLES $\pm 0.8^\circ$; 2 PL ± 0.040 ;
 3 PL ± 0.020

TITLE Laminate Shape: Left Parallelogram		
SUBTITLE 42"x42"x2		
PART NO: Shape-5-04-XX	REV. 1.0	
SIZE: 34"x22"	SCALE: 0.17	SHEET 1 OF 1
FILE NAME: Left Parallelogram (42.42.2).dft		