

REVISION HISTORY			
REV.	DESCRIPTION	DATE	APPROVED

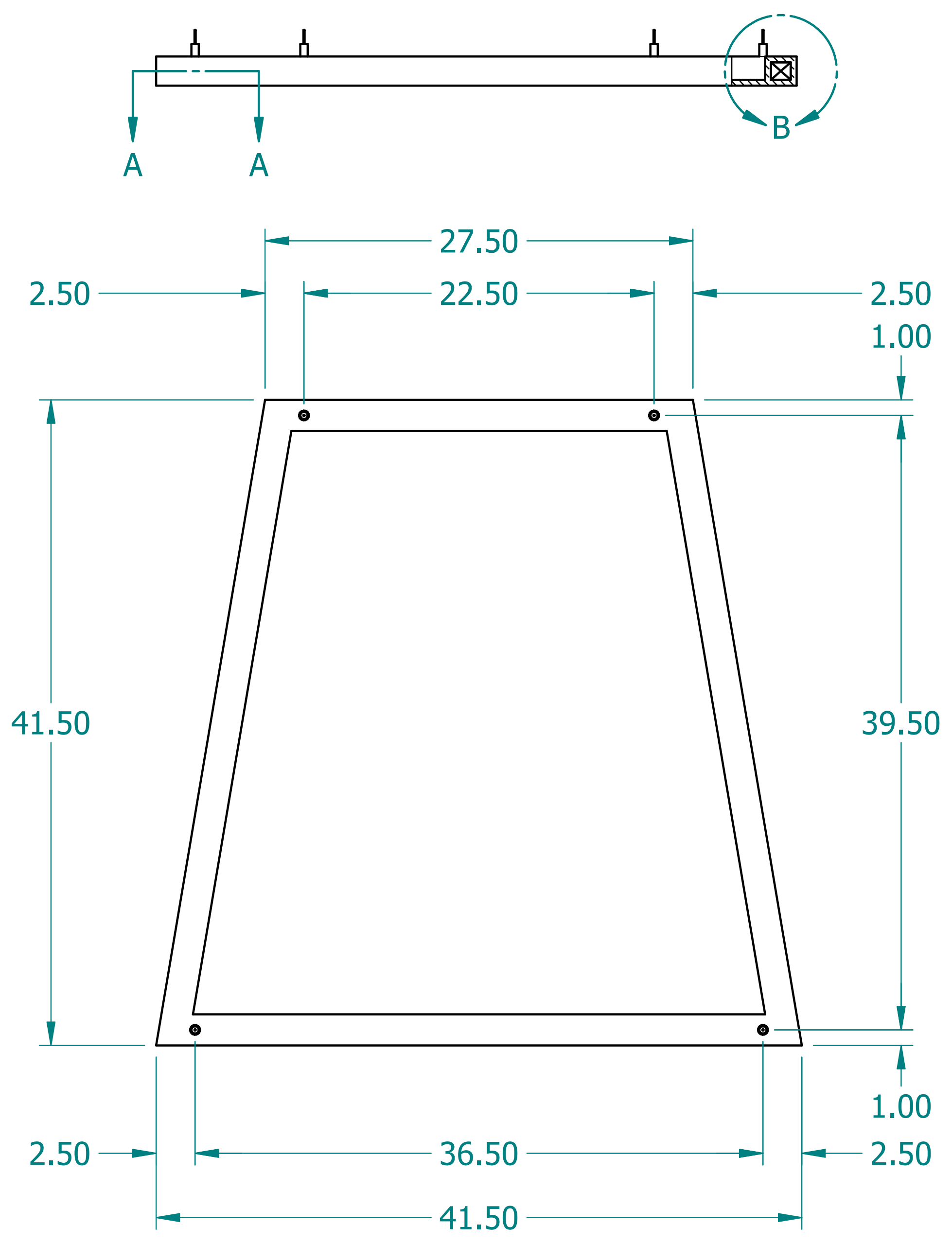

SECTION A-A

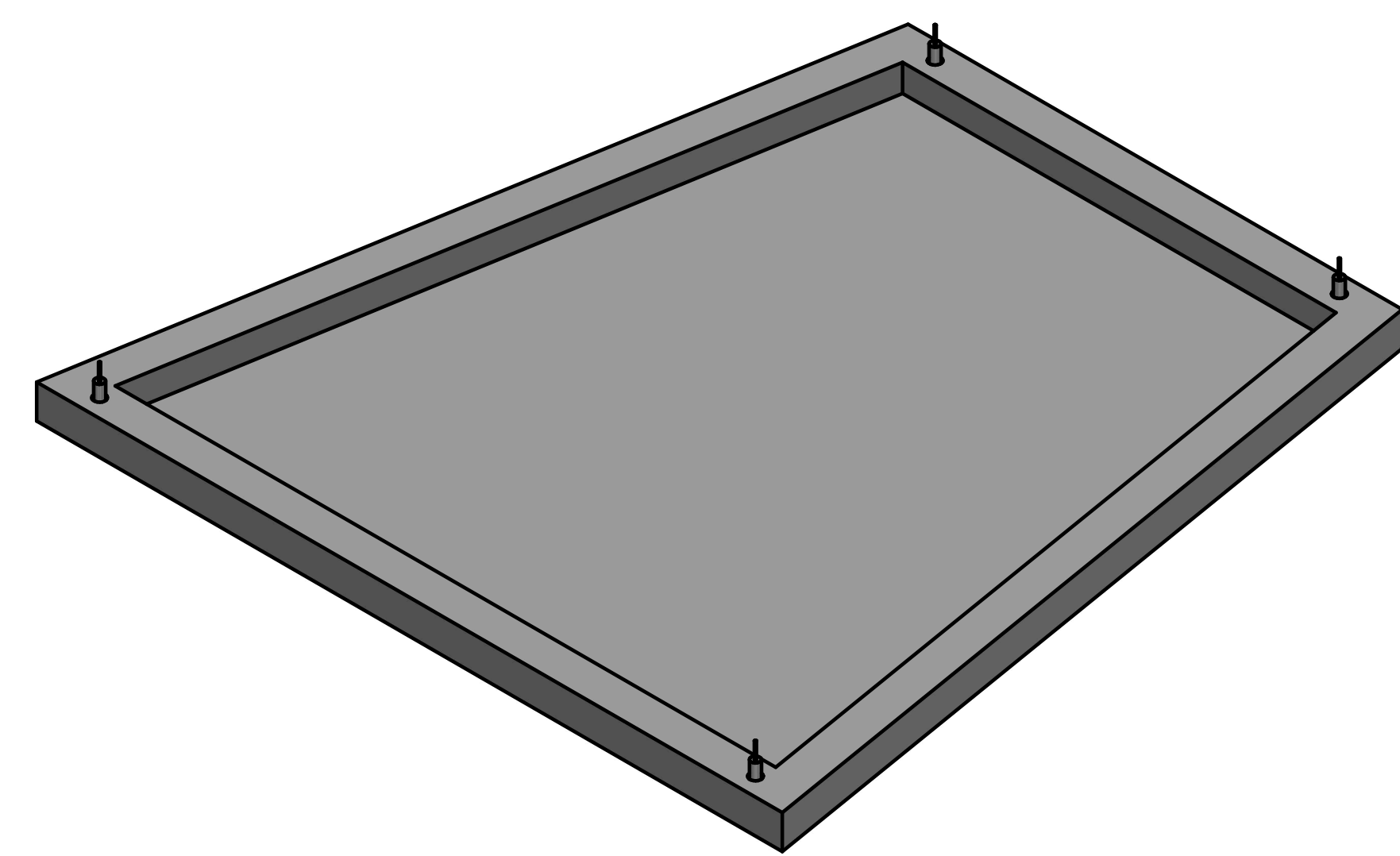
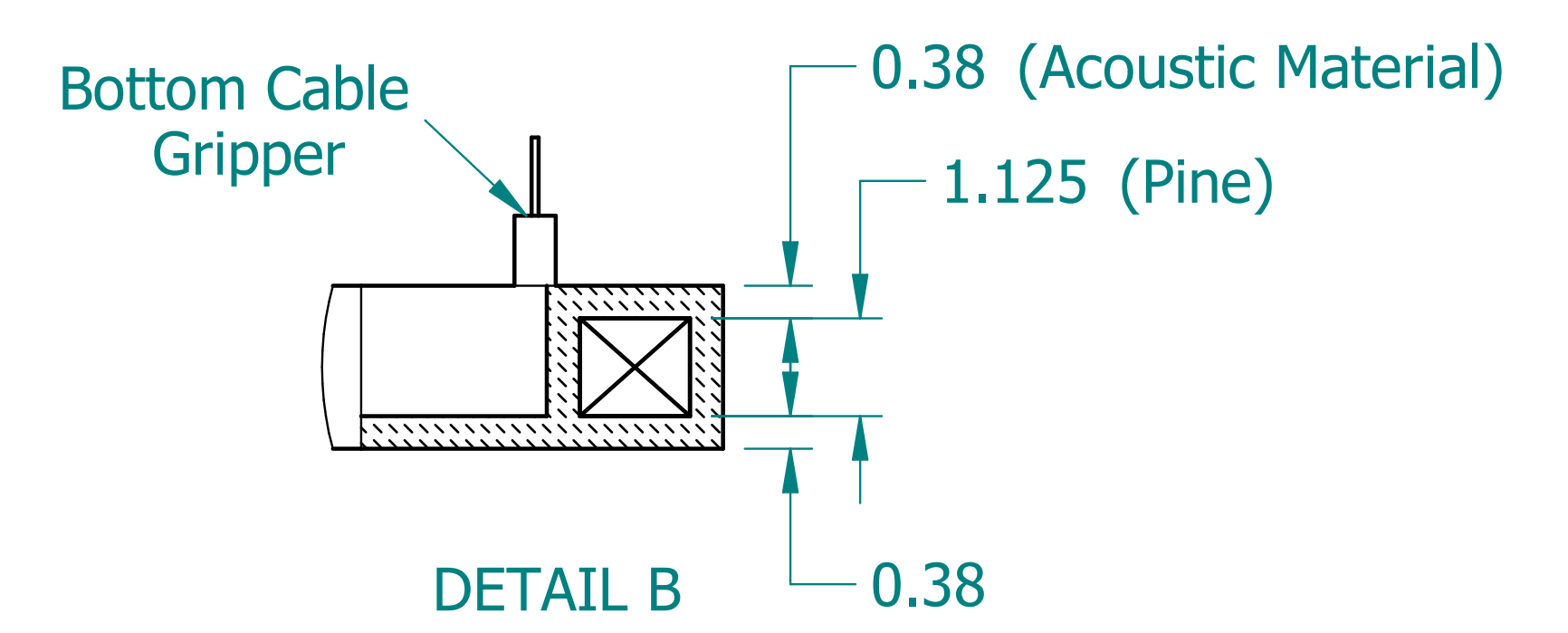
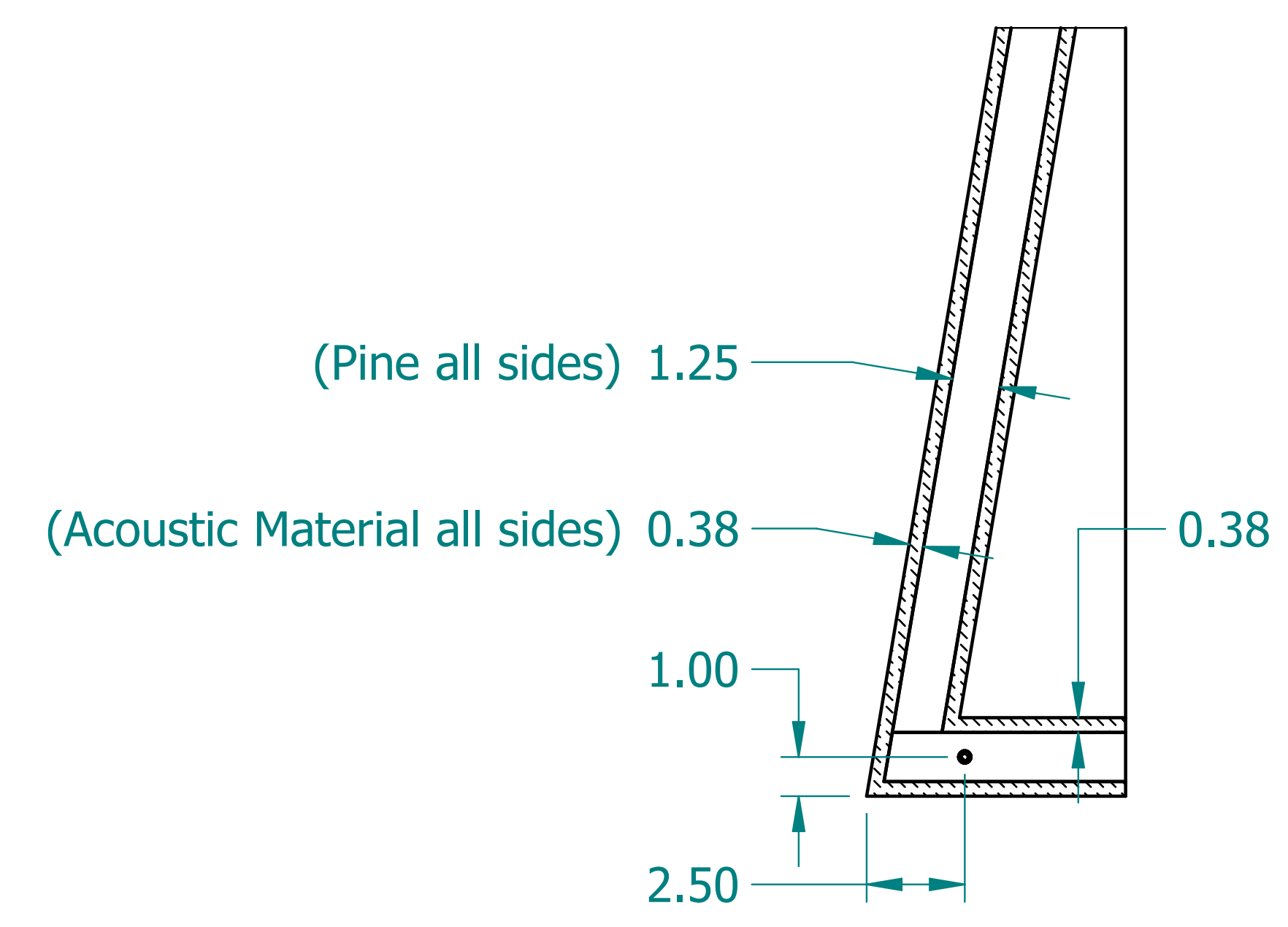

	NAME	DATE
DRAWN	SAI	05/01/20
ENG APPR	ERIC	05/01/20



UNLESS OTHERWISE SPECIFIED DIMENSIONS ARE IN 'INCHES'
 ANGLES $\pm 0.8^\circ$; 2 PL ± 0.040 ;
 3 PL ± 0.020

TITLE Acoustic Shape: Trapezoid		
SUBTITLE 42"x42"x2"		
PART NO: AShape-4-04-XX	REV. 1.0	
SIZE: 34"x22"	SCALE: 0.17	SHEET 1 OF 1
FILE NAME: Acoustic Trapezoid (42.42.2).dft		