

ELEVATION

3/4" = 1'-0"

NOTES:

- ALL DOORS INCLUDE FACTORY PRE-MACHINING FOR HARDWARE.
- ALL DOORS INCLUDE FACTORY SEALING OF EDGES.
- FACTORY PRE-FINISHING IS OPTIONAL. SPECIFIED FACTORY FINISH TO BE: ____.

LEGEND:

1. WOOD FACE VENEER (PULL SIDE). FACE VENEER TO BE: ____.
2. WOOD FACE VENEER (PUSH SIDE). FACE VENEER TO BE: ____.
3. ACOUSTIC CORE.
4. HARDWOOD STILES AND RAILS.
5. SWEEP SEAL.
6. 1/4" HIGH FLAT ACOUSTIC THRESHOLD.
7. FINISHED FLOOR COVERING MATERIAL.

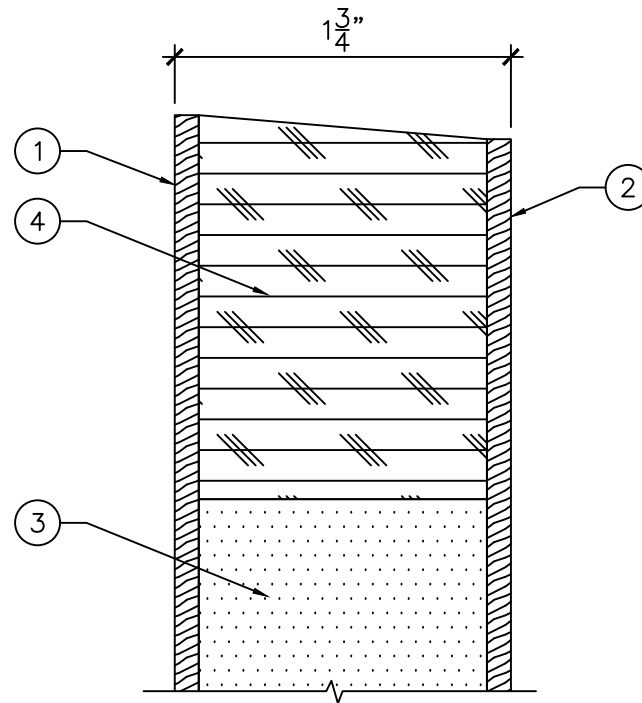

TOP DETAIL "A"

1"-0" = 1'-0"

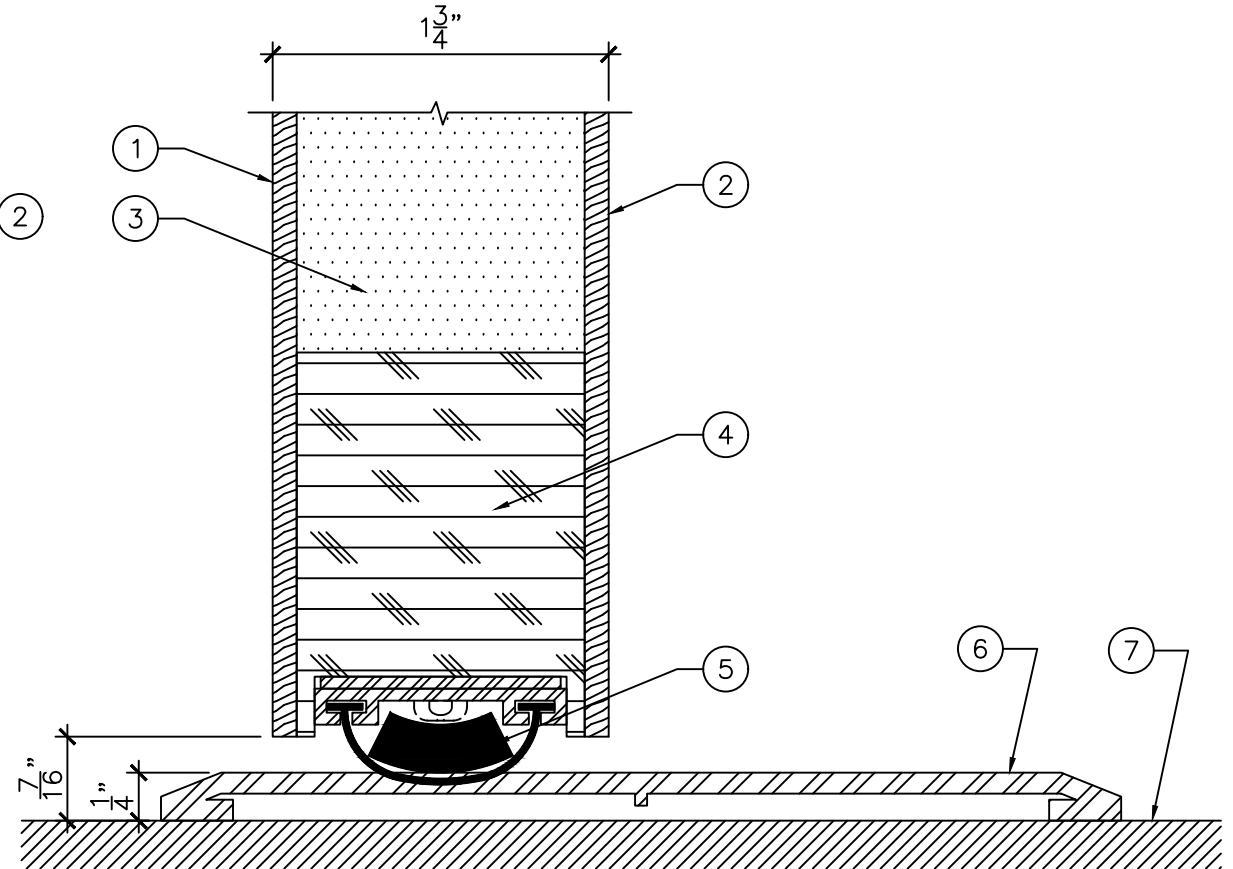

BOTTOM DETAIL "B"

1"-0" = 1'-0"



DRAWING TITLE:

**WOOD CLAD ACOUSTIC DOOR - NON FIRE RATED
FROM STC 36 TO STC 40**

DATE: OCTOBER 17, 2016

DRAWN BY: TWB

REVISION: 0