

I: GLAZING MATERIAL

INNER OUTER

POLYCARBONATE DOME

2: GLAZING COLOR

CLEAR
 BRONZE N/A
 WHITE
 OTHER _____

3: FRAME FINISH

MILL
 BRONZE ANODIZED
 CLEAR ANODIZED
 CUSTOM COLOR _____

4: PYRAMID PITCH (OPTIONAL)

22 DEGREE (1/2 WIDTH X .414)
 30 DEGREE (1/2 WIDTH X .577)
 40 DEGREE (1/2 WIDTH X .839)

OSHA (Standards-29 CFR)-1910.23(e)(8)

FOR SELF FLASHING SKYLIGHTS PROVIDE
 ROUGH OPENING OR ID OF SKYLIGHT DIMENSION

QTY: R.O. = X
 QTY: R.O. = X
 QTY: R.O. = X
 QTY: R.O. = X
 QTY: R.O. = X

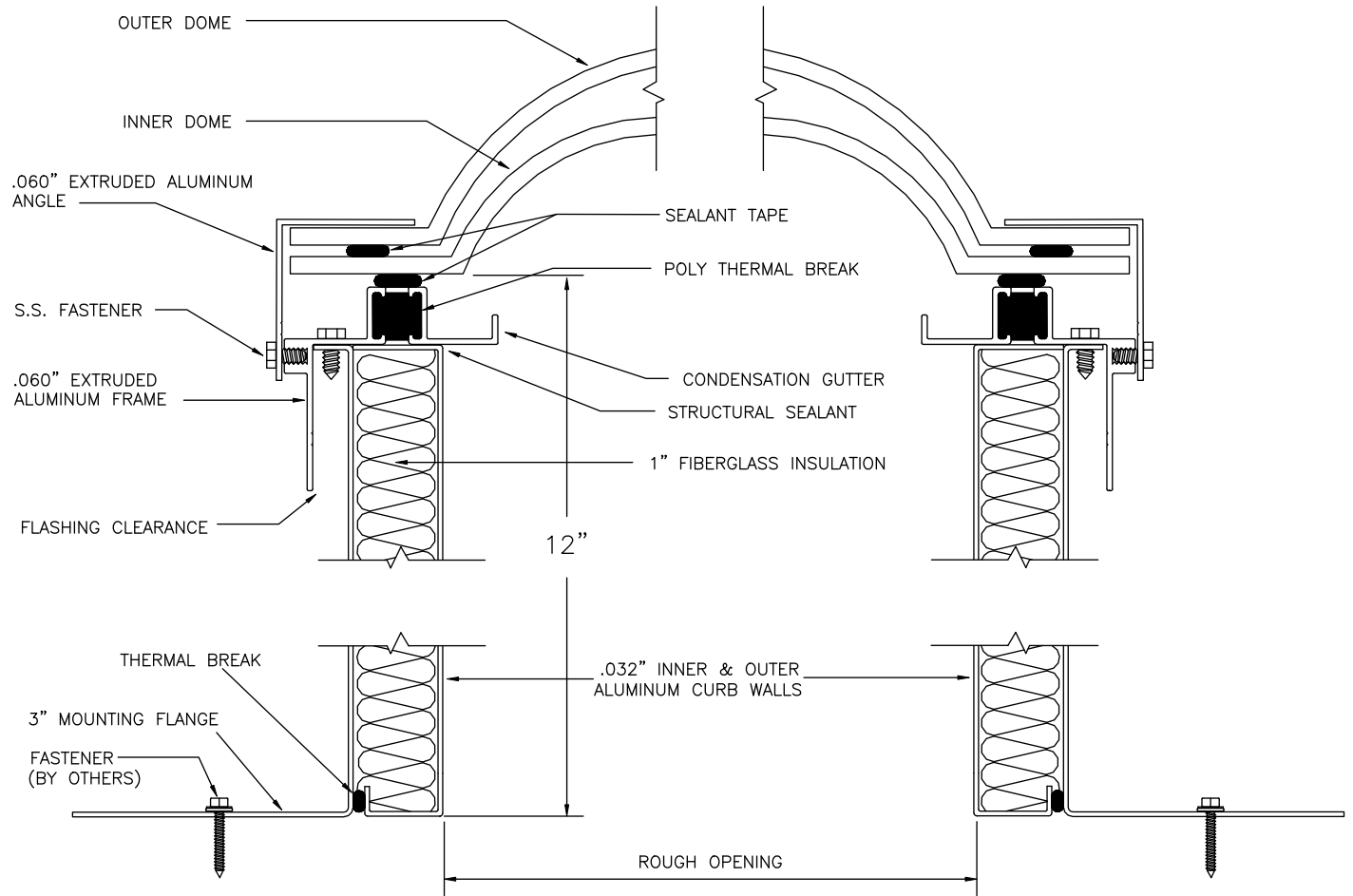

**12" THERMALLY BROKEN & INSULATED SELF FLASHING
 FALL PROTECTION RATED UNIT
 (MODEL TSF-12-FG)**



AMERICAN SKYLIGHTS

Phone: 855.772.7401 Fax: 855.445.7282