

GRADE  
**STYLE 'A'**  
POST MOUNTED

**STYLE 'B'**  
POST MOUNTED

**STYLE 'C'**  
OFFSET WALL OR  
POST MOUNTED

**STYLE 'D'**  
WALL OR POST MOUNT

**STYLE 'DA5'**  
PAD MOUNTED

**STYLE 'E'**  
\* STANDARD \*  
PAD MOUNTED

**STYLE 'DUAL SPLIT'**  
FOR DUAL GATES 8' AND TALLER  
MOUNT HIGH ON PRIMARY, LOW ON SECONDARY  
(UNLESS OTHERWISE SPECIFIED)

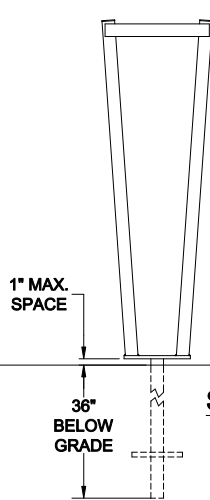
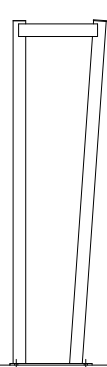
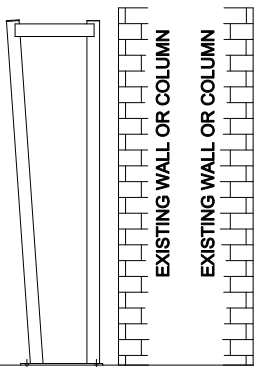
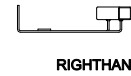
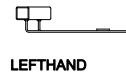
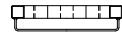
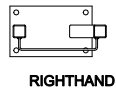
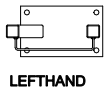

**STYLE 'G'**  
BURIED IN  
THE GROUND

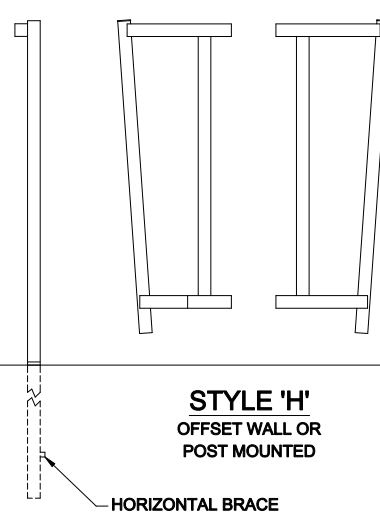

**STYLE 'H'**  
OFFSET WALL OR  
POST MOUNTED

**STYLE 'BARRACUDA'**  
PAD MOUNTED OR BURIED

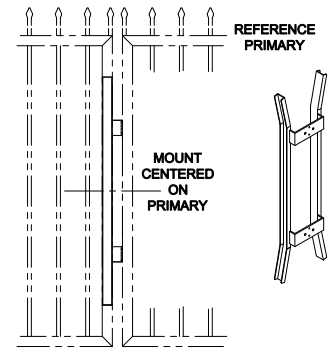
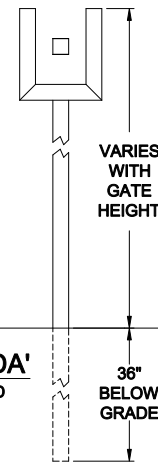

**STYLE 'DUAL CENTER'**  
FOR DUAL GATES SHORTER THAN 8'  
MOUNTED ON THE PRIMARY GATE  
(UNLESS OTHERWISE SPECIFIED)

**NOTES:**

- \* STANDARD PAD AND POST MOUNTED YOKE ARE 5" TALL.
- \* STYLES 'G' AND 'BARRACUDA' RECESS ADDITIONAL 36" BELOW GRADE.
- \* STYLES 'A','B','C','D' & 'H' ARE MOUNTED 5" ABOVE GRADE.
- \* UNLESS SPECIFIED, GATE IS FURNISHED WITH STYLE 'E'.
- \* PRIMARY AND SECONDARY YOKE CONFIGURATION BASED ON HEIGHT.

**NOTICE**

THE INFORMATION CONTAINED ON THIS DOCUMENT IS CONFIDENTIAL. ANY DISSEMINATION, UNAPPROVED DISCLOSURE OR COPYING OF THIS INFORMATION IS STRICTLY PROHIBITED

Date: 12/21/05  
Dm. By: MKS  
Ckd. By: DMR



**DO NOT SCALE**

Rev.:	Description:	Date:	Dm. By:	Ckd. By:
D	RE-ARRANGED ALL & ADDED DUAL STYLE YOKE	11/25/14	KAY	DMR

Rev.:	Description:	Date:	Dm. By:	Ckd. By:
C	ADDED "DA5" STYLE YOKE (DOUBLE PAD MOUNTED)	07/01/14	MKS	EGS
B2	ADDED "H" STYLE YOKE	01/17/13	SLD	KLL
B1	ADDED BARRACUDA STYLE YOKE	01/17/13	SLD	SLD
A	ADDED FLATBAR TO STYLE "B" YOKE	08/27/10	MKS	DMR

UNLESS OTHERWISE SPECIFIED DIMENSIONS ARE IN INCHES ANGLES ± 1°  
XX ± 1/32, .XX ± .01, .XXX ± .005

Dwg.: 105 YOKE STYLES

Title: YOKE STYLES (5' STANDARD)