

**ASSA ABLOY**

ASSA ABLOY Entrance Systems  
1900 Airport Road  
Monroe, NC 28110  
Phone: 1-866-237-2687  
specdesk.na.besam@assaabloy.com

BESAM RD4A-2  
REVOLVING DOOR SYSTEM  
PLAN VIEW

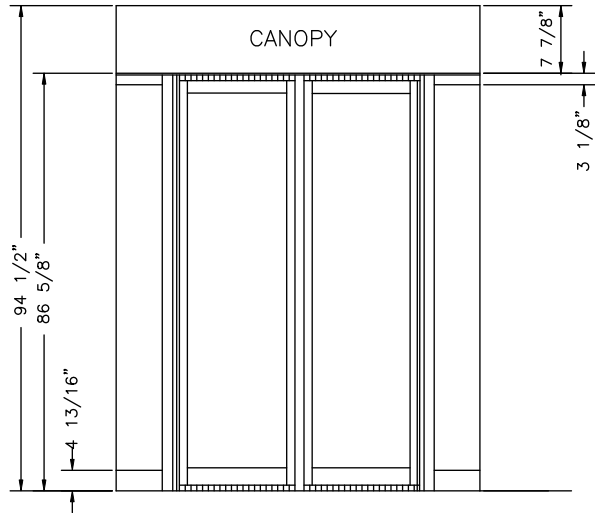

ELEVATION

OVERHEAD CEILING MOUNTED ANTI-TAILGATING SENSOR SYSTEM. OPTIONAL ANTI-PIGGYBACKING SENSOR SYSTEM IS AVAILABLE.

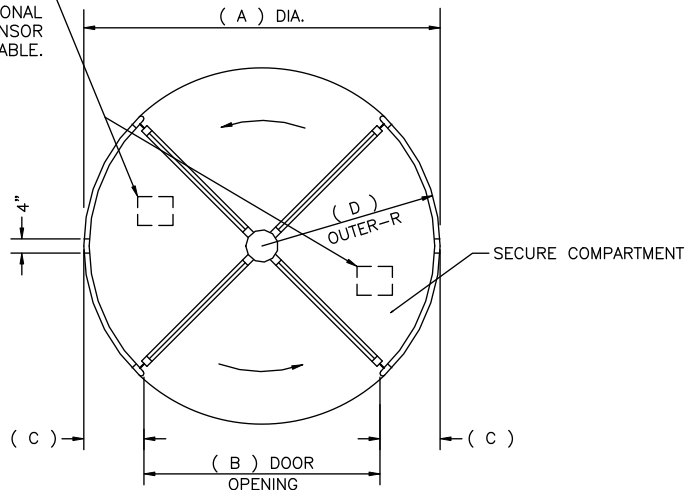

PLAN VIEW

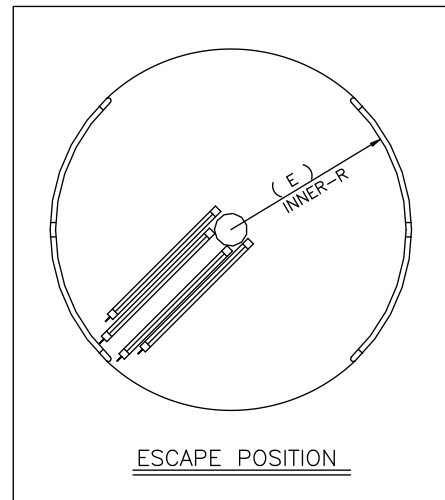

ESCAPE POSITION

42" WIDE LOW ENERGY AUTOMATIC ADA APPROVED SWING DOOR WITH INTERLOCKING ELECTRO-MAGNETIC LOCKING SYSTEM. ACCESS CONTROL DEVICE REQUIRED FOR PASSAGE.

TYPICAL ACCESS CONTROL REVOLVER WITH HANDICAP SWING DOOR ENTRANCE.

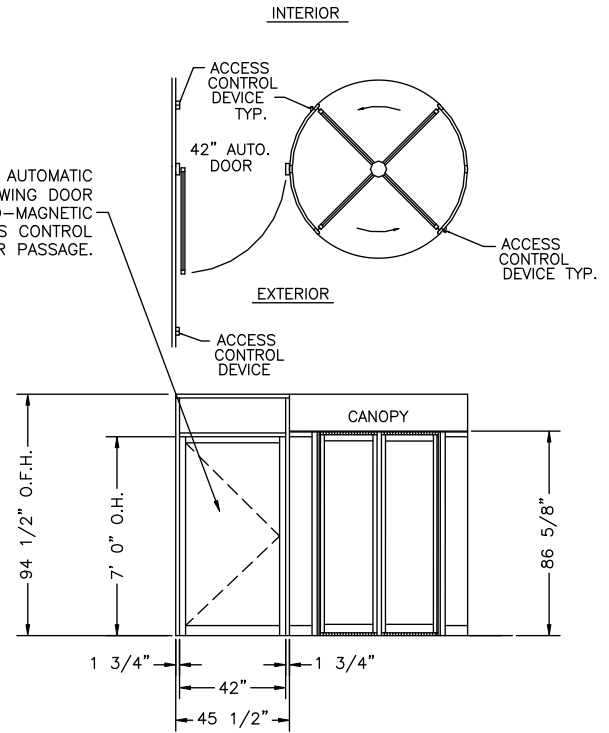

MODEL #	OVERALL DIAMETER (A)	DOOR OPENING (B)	(C)	OUTER RADIUS (D)	INNER RADIUS (E)	OVERALL FASCIA HEIGHT
RD4A-2-6	74 1/4"	47 1/4"	13 1/2"	37 1/8"	35 3/8"	94 1/2"
RD4A-2-7	86 1/8"	55 5/8"	15 1/4"	43 1/16"	41 5/16"	94 1/2"
RD4A-2-8	98"	64"	17"	49"	47 1/4"	94 1/2"

DWG NO. RD4A-2	SHEET 1 OF 2
DRN BY D.D.D. DATE 5/12/99	CHK BY DATE REV. D DATE 5/30/14

BESAM RD4A-2 2 WAY ACCESS CONTROL  
REVOLVING DOOR SYSTEM  
PLAN VIEW

**ASSA ABLOY**

ASSA ABLOY Entrance Systems  
1900 Airport Road  
Monroe, NC 28110  
Phone: 1-866-237-2687  
specdesk.na.besam@assaabloy.com