

D

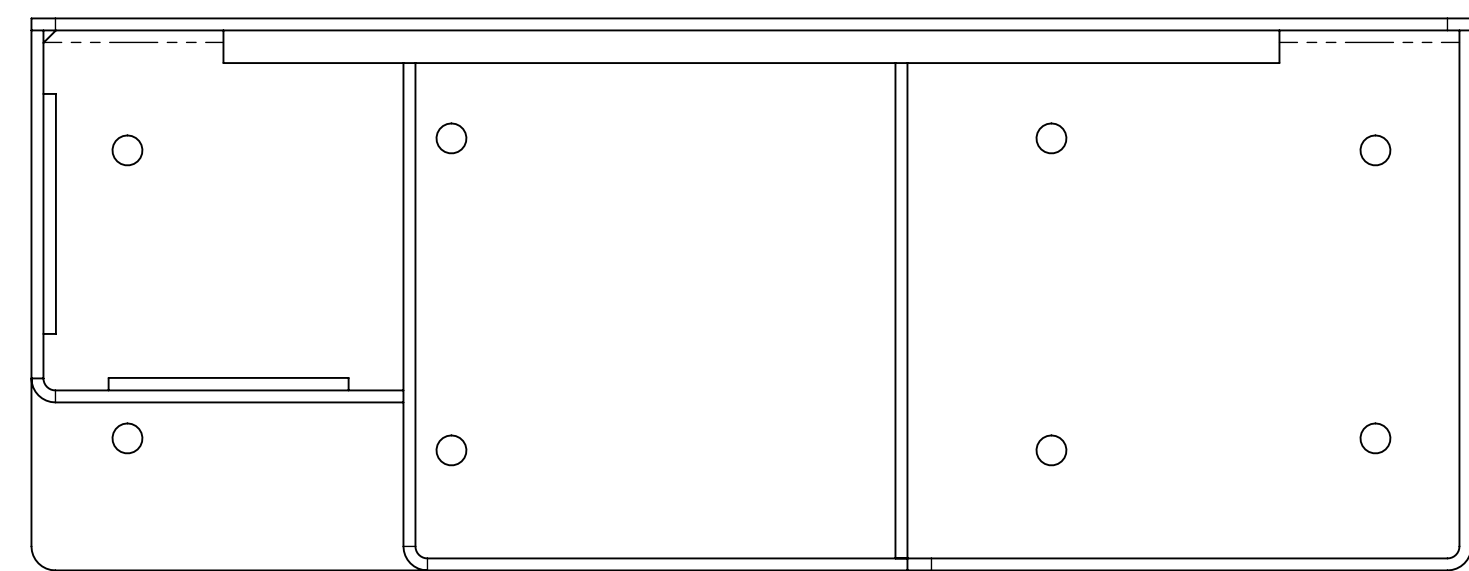

C

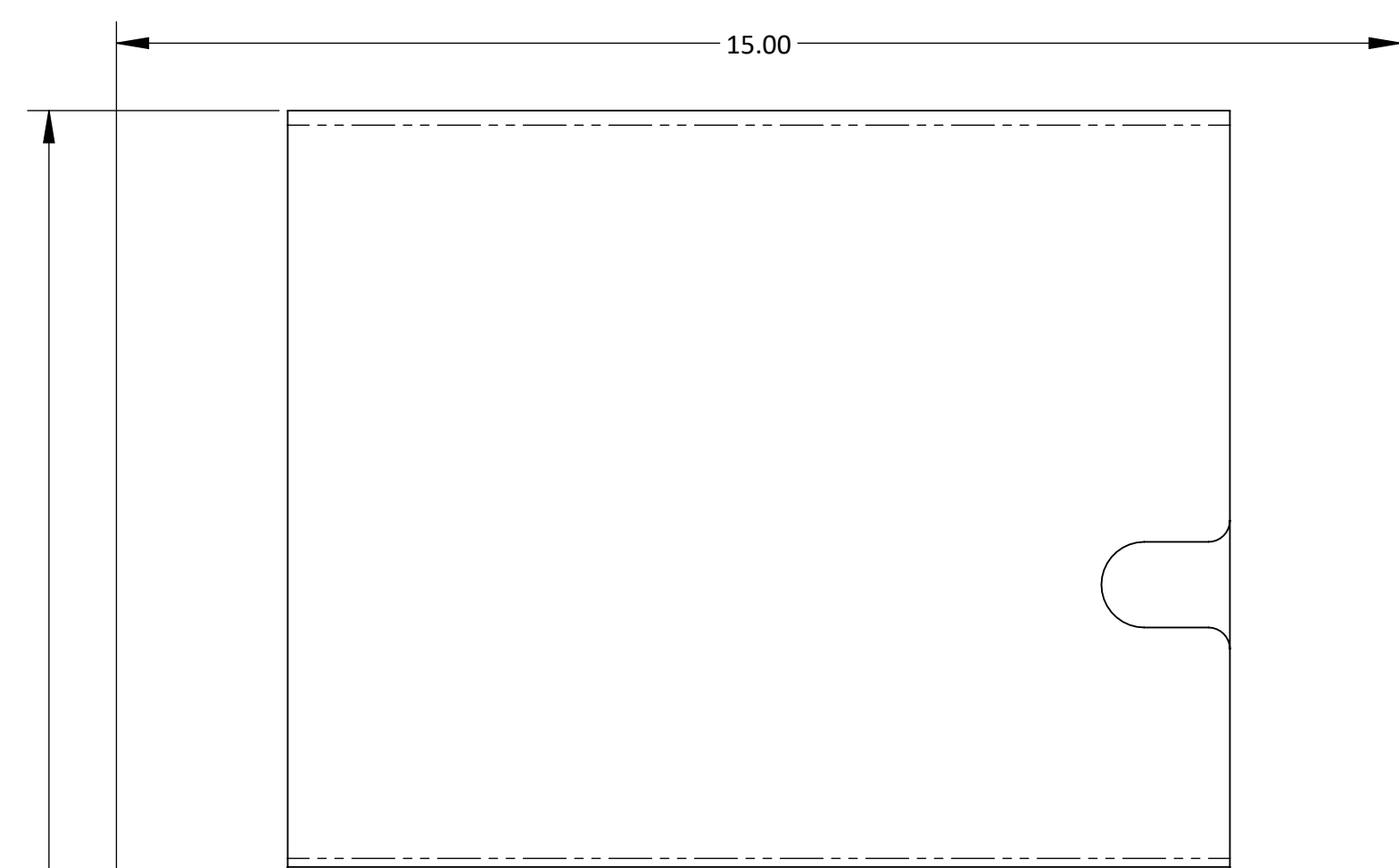

B

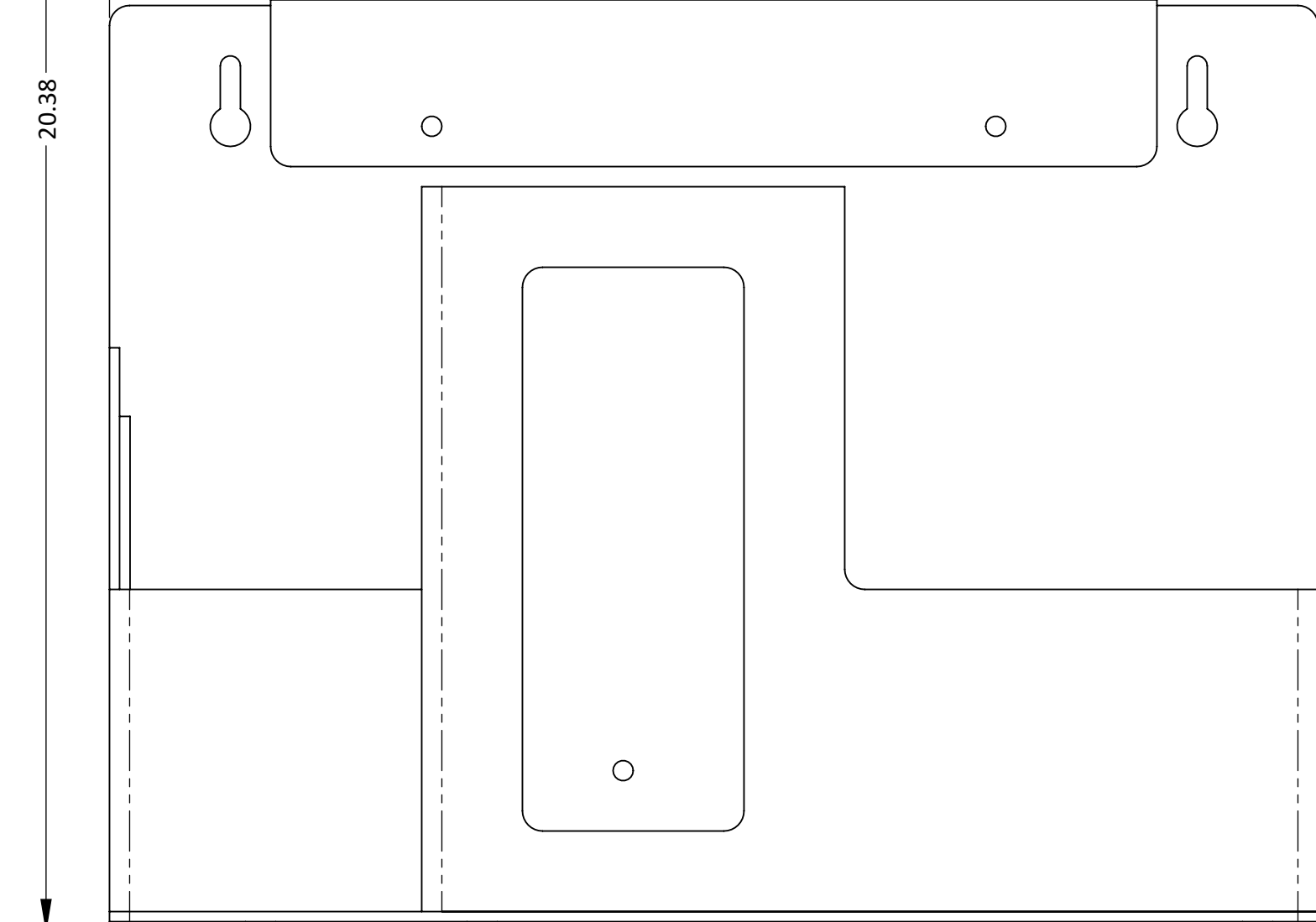

A

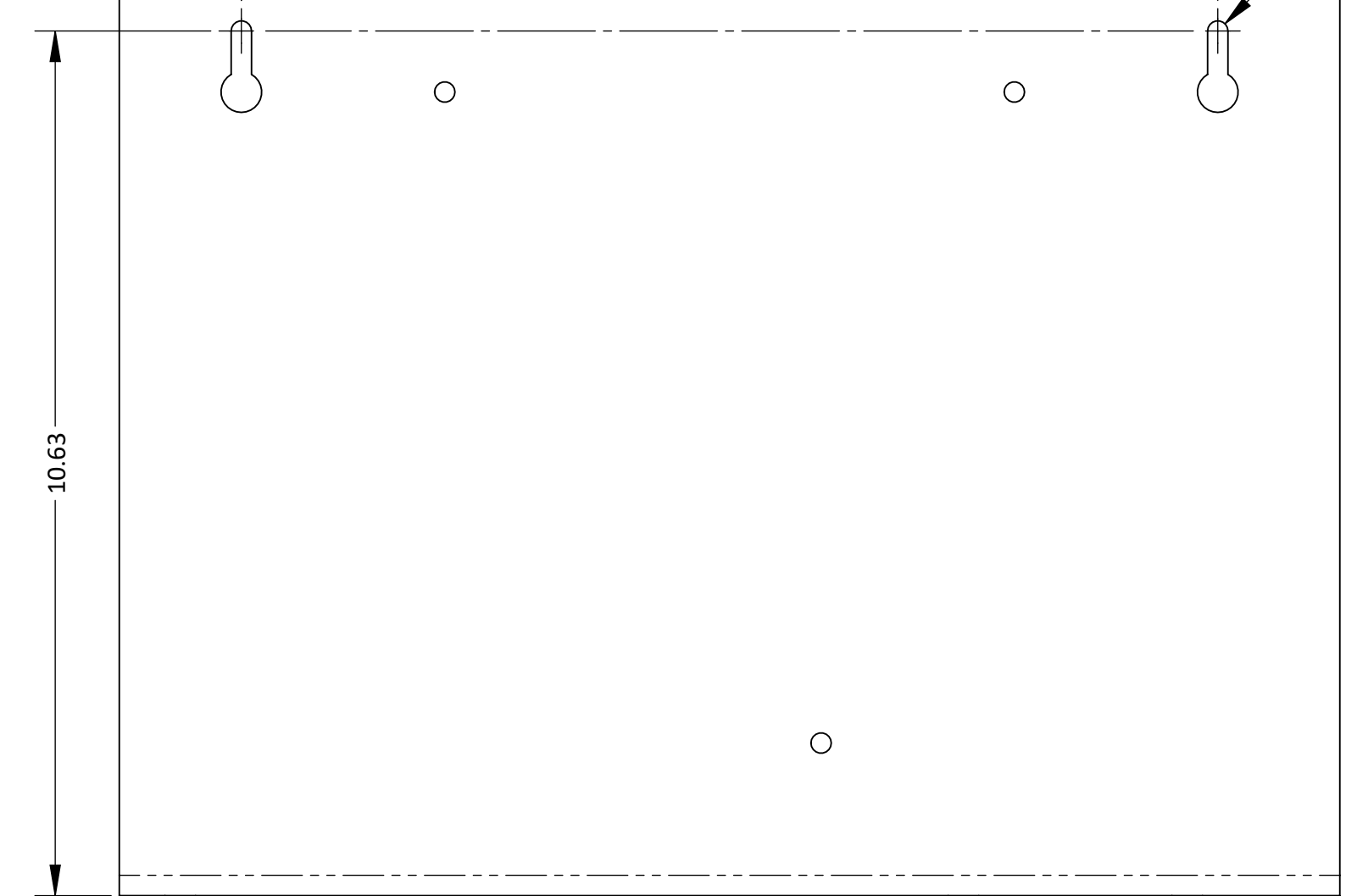
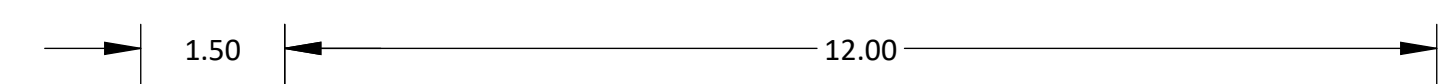
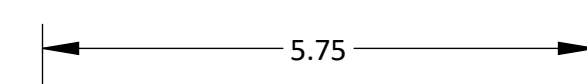

Ø .25(2X)
MOUNTING HOLES

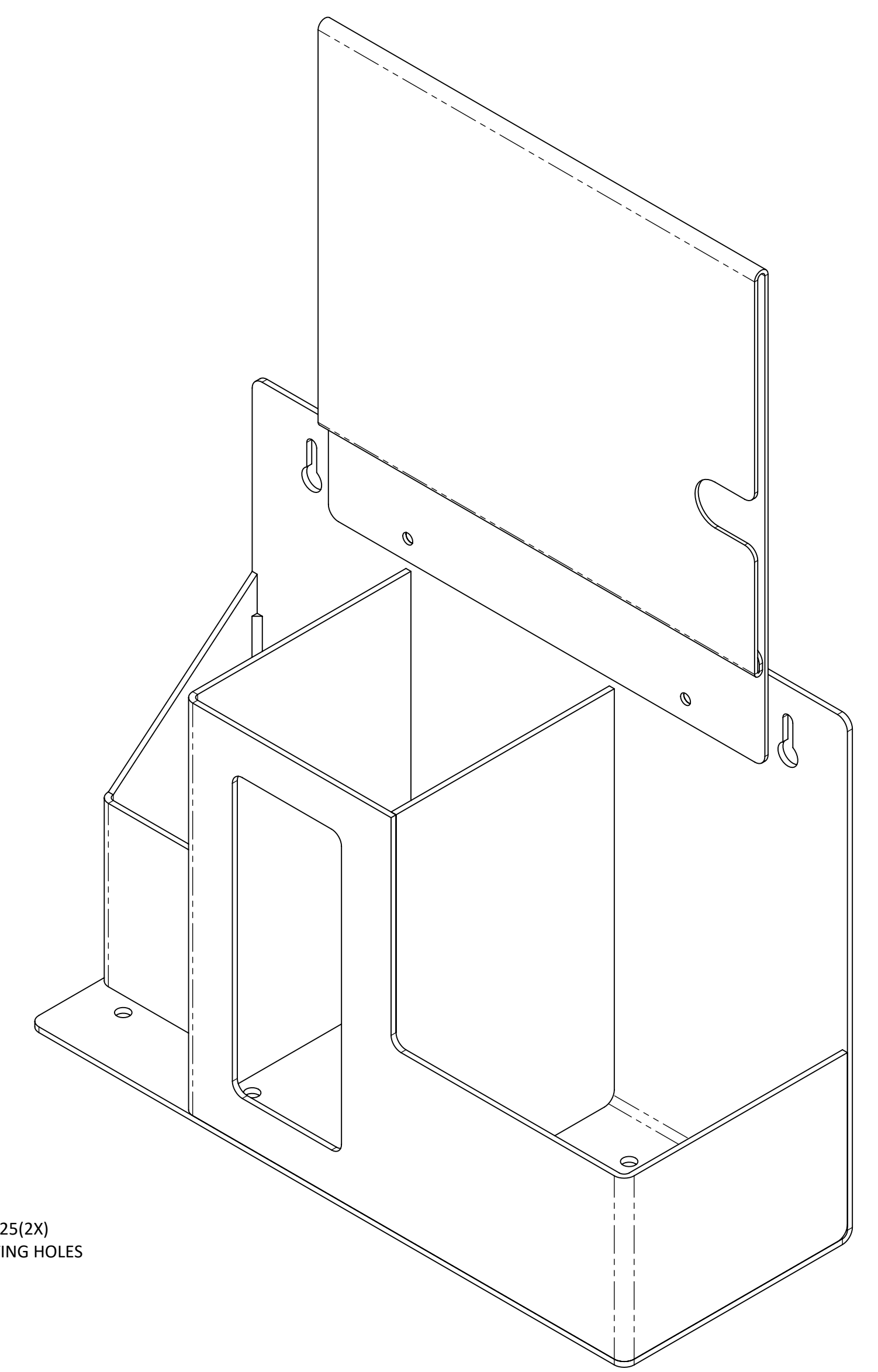

D

C

B

A

MATERIAL: ABS Plastic/PETG Plastic		PART NO.: ED-097	
FINISH: Quartz Beige/Clear		TITLE: INFECTION PREVENTION SYSTEM	
BOWMAN Dispensers	BOWMAN Dispensers 20325 71st Ave NE, Ste D Arlington, WA 98223		TOLERANCE .XX = ± .03 .XXX = ± .010 ANGULAR = ± 1°
	SCALE 1:2	REV G	SHEET 1 of 1

FILE NAME: ED-097_ARCAT_SLDDRW