

LEGEND

- 1 FIBER CEMENT CLADDING SHEETS
- 2 BREATHABLE WATERPROOF MEMBRANE
- 3 3/4" MINIMUM SPACER FOR VENTILATION
- 4 AIR SPACE
- 5 3 1/2" EPDM RUBBER STRIP
- 6 1 1/4" EPDM RUBBER STRIP
- 7 STAINLESS STEEL SCREW

LEGEND

- 8 FLASHING
- 9 3/4" MIN. DISTANCE FROM FLASHING
- 10 BACKER ROD & SEALANT
- 11 INSULATION
- 12 VERTICAL BATTEN
- 13 HORIZONTAL BATTEN

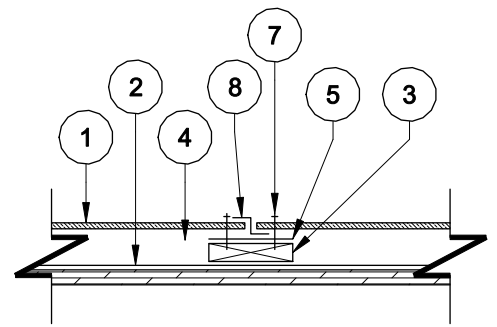
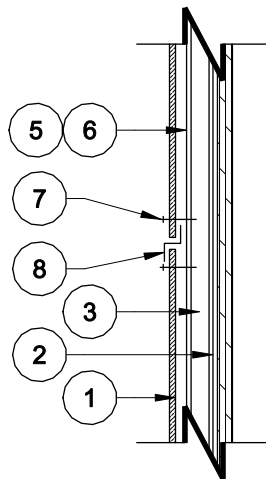
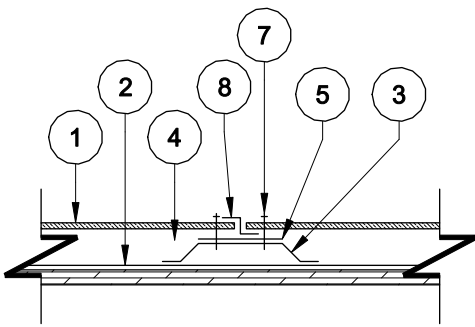

CBF

CEMENT BOARD FABRICATORS, INC.
T (800) 366-5378 / F (502) 774-5757 / INFO@CBF11.COM / WWW.CBF11.COM

JOINT SOLUTIONS
COVERED JOINTS - OPTION 2

5/1/2014