

REVISION STATUS - ALL SHEETS ARE THE SAME REVISION				
ZONE	REV.	DESCRIPTION	DATE	APPROVED
	X1	DEVELOPMENT	02/01/2017	KRH

NOTES: UNLESS OTHERWISE SPECIFIED

- 1 MATERIAL: ASTM A36, HOT ROLLED STEEL, OR CENTERLINE STEEL, LLC APPROVED EQUIVALENT.
- 2 ALL DIMENSIONS ARE TO THEORETICAL SHARP.
- 3 REMOVE BURRS AND BREAK ALL SHARP EDGES .03 MAX.
- 4 ALL DIMENSIONS ARE IN INCHES UNLESS STATED OTHERWISE.
- 5 PARTS SHALL BE FREE OF GREASE AND CUTTING FLUID.
- 6 POWDER COAT PER MIL-PRF-24712A (TYPE 3, CLASS 3)

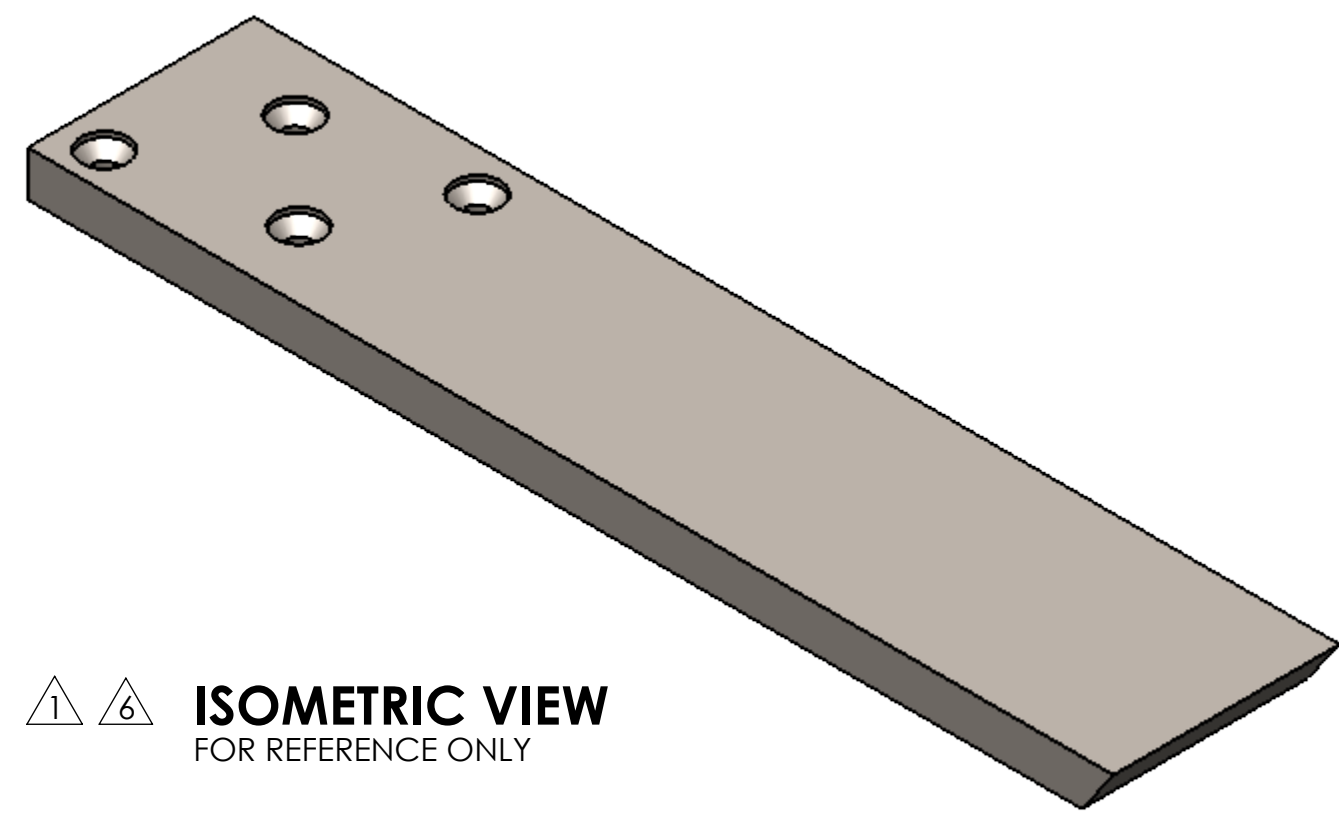

ISOMETRIC VIEW
FOR REFERENCE ONLY

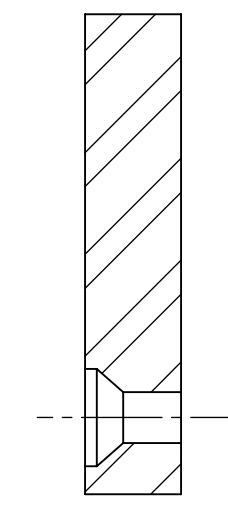
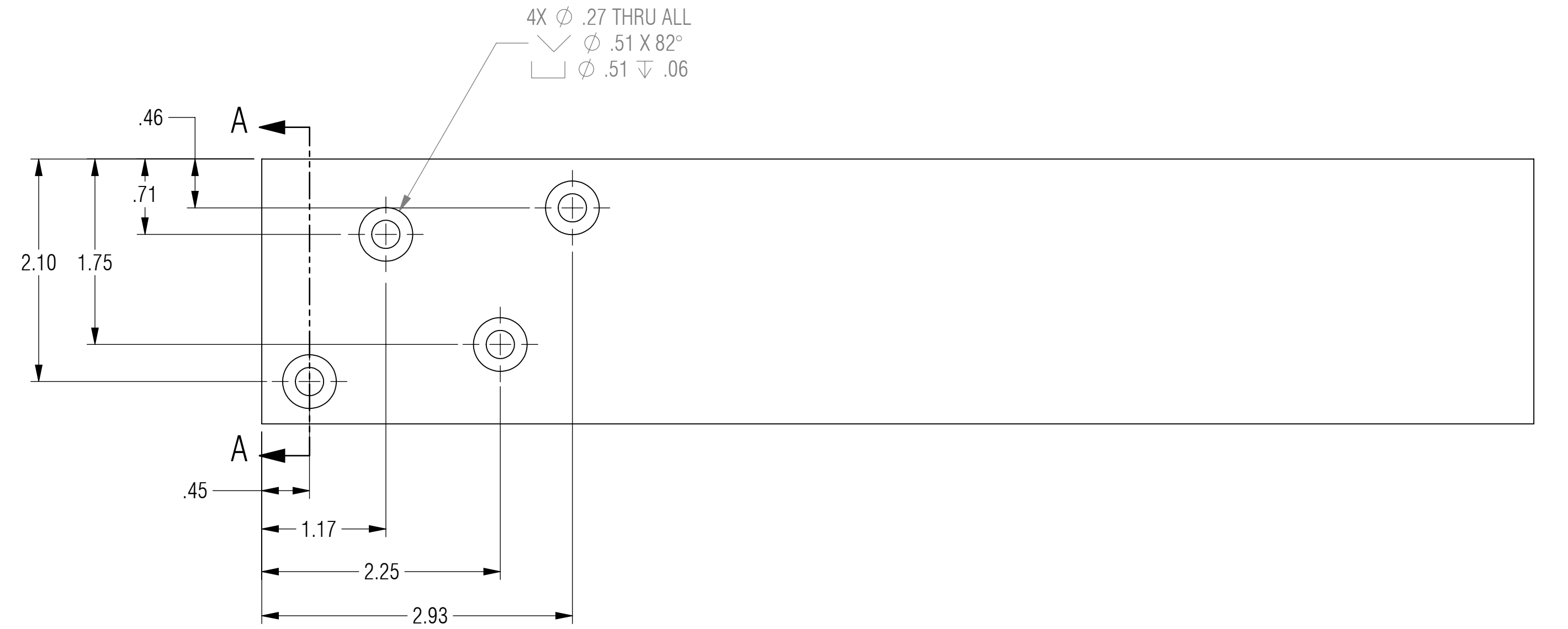

SECTION A-A

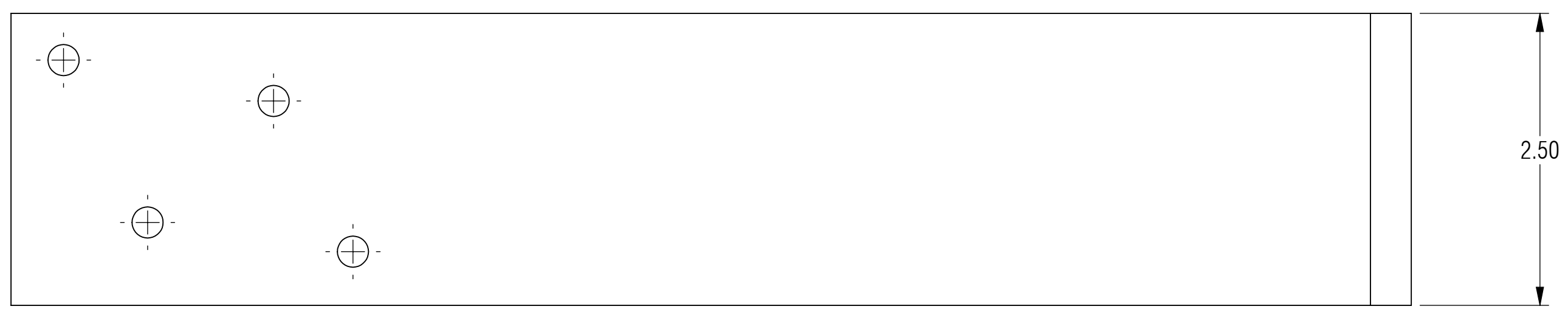

RELEASED

UNLESS OTHERWISE SPECIFIED: DIMENSIONS ARE IN INCHES		ENGINEER		
TOLERANCES ARE:		ENGINEER		
.XX ± .01	ANGLES XX° ± 1°	CHECKED	CAS 02/01/2017	
.XXX ± .005		DRAWN	KRH 02/01/2017	
INTERPRET DRAWINGS IN ACCORDANCE WITH:		MANAGER APPROVAL		THE INFORMATION ON THIS DRAWING IS PROPRIETARY AND SHALL NOT BE DISCLOSED, USED, OR DUPLICATED FOR PROCUREMENT OR MANUFACTURING PURPOSES WITHOUT THE EXPRESS WRITTEN CONSENT OF CENTERLINE STEEL, LLC
ASME Y14.100 ENGINEERING DRAWING PRACTICES	ASME Y14.38 ABBREVIATIONS	THIRD ANGLE PROJECTION		
ASME Y14.5 DIMENSIONING AND TOLERANCING	ASME Y14.6 SCREW THREAD REPRESENTATION			
ASME Y14.8 CASTINGS, FORGINGS & MOLDED PARTS	AWS A2.4 WELDING SYMBOLS	USED ON APPLICATION		DRAWING NO SB4H-12
IEEE STD 315 SYMBOLS FOR ELECTRICAL AND ELECTRONIC DIAGRAMS		SCALE 1:1		REV X1
			SHEET 1 OF 1	