

11A BASE INSIDE CORNER, OPTION 1

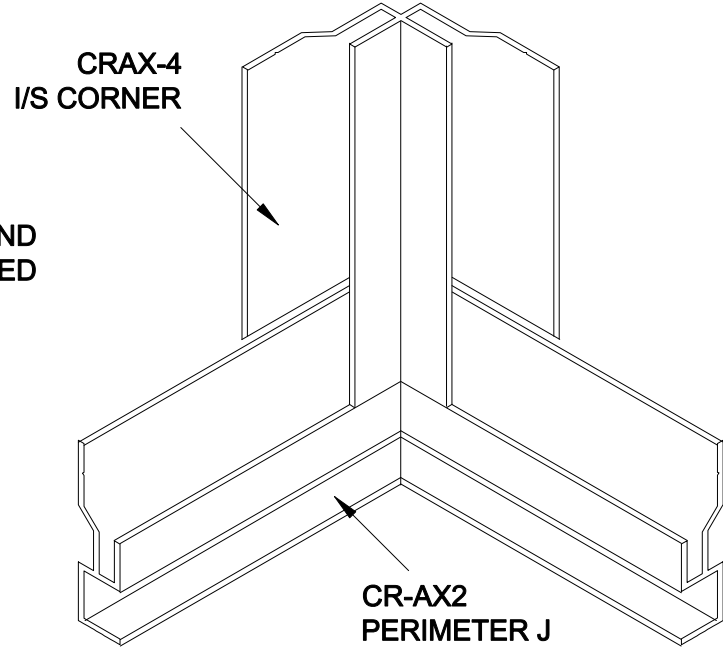

11B BASE INSIDE CORNER, OPTION 2

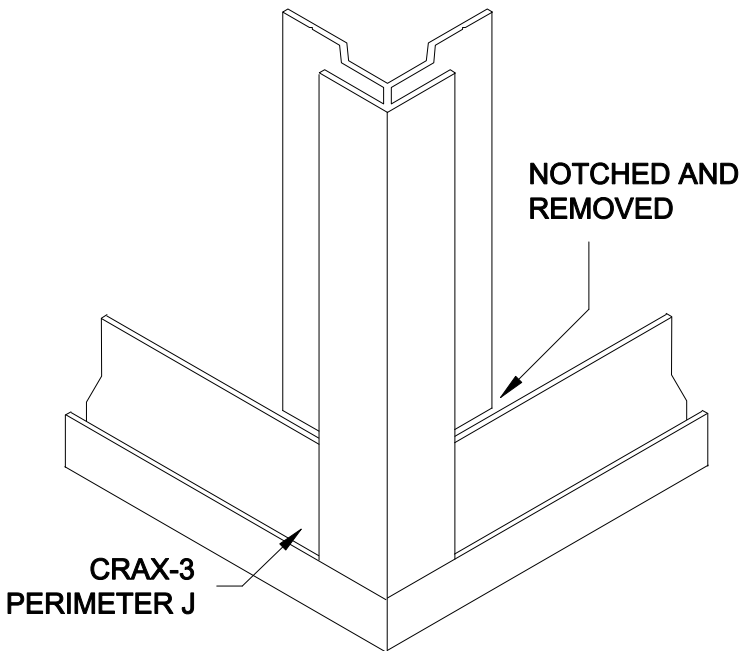

12A BASE OUTSIDE CORNER, OPTION 1

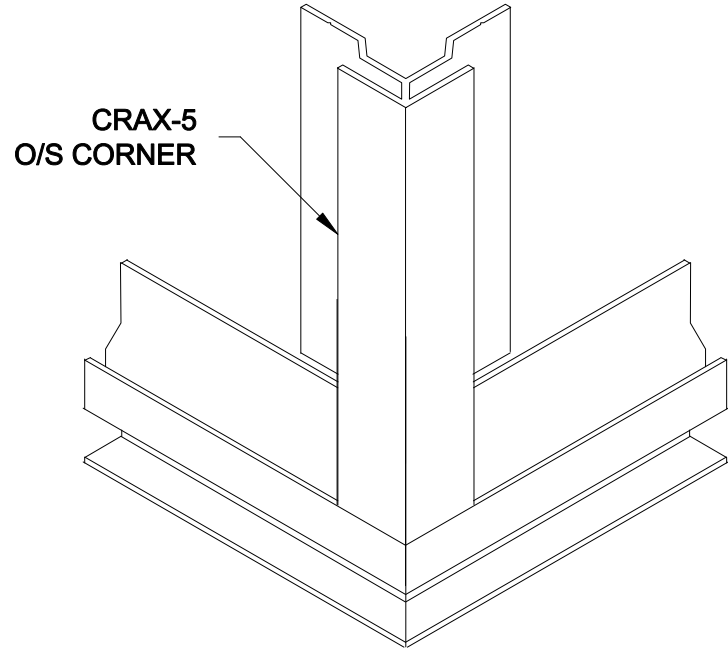

12B BASE OUTSIDE CORNER, OPTION 2