

NOTES: UNLESS OTHERWISE SPECIFIED

1. DIMENSIONS ARE IN INCHES (mm).

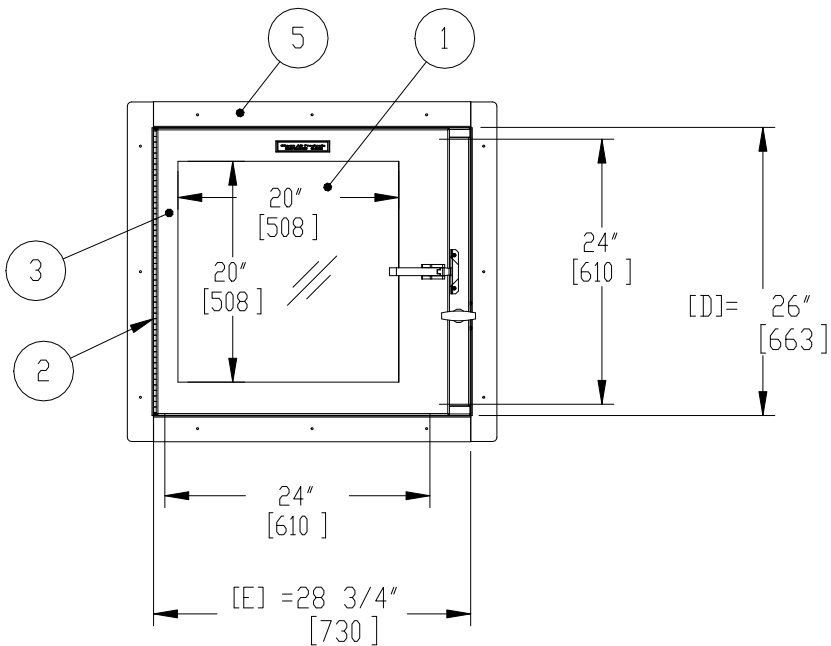
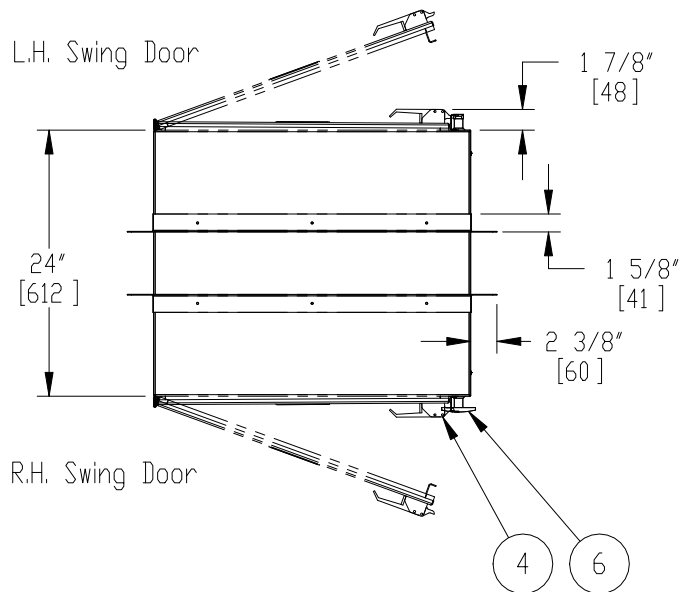

Features:

1. Clear Tempered Safety Glass
2. Stainless Steel Flush Mount Hinge
3. Stainless Steel Door Frame
4. Lever Compression Door Latch, Stainless Steel

Options Shown:

5. 8 Pc. Stainless Steel Mounting Frame
6. Interlock Handle, T, Non-Locking Stainless Steel

Notes:

1. Wall Cutout is $29-1/4" \times 26-1/2"$
([E] + 1/2" x [D] + 1/2")
2. Material: Stainless Steel, Type 304, #4 Finish
3. Electrical Requirements: None

Pass Thru Operation - One Hand :
Turn Interlock Handle (6) to
Operate Interlock
Pull Door Latch (4) to open door

Customer Wall
Between Frames

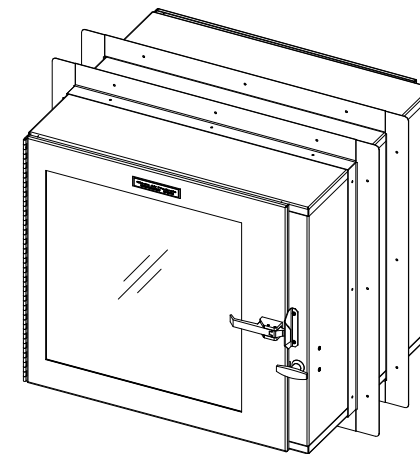
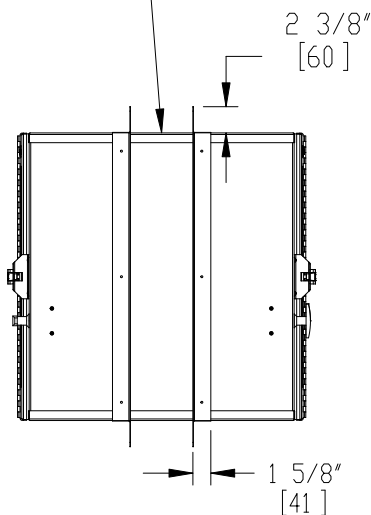

Note:
Interlocking and non-interlocking
units have the same exterior
dimensions unless noted

© COPYRIGHT 2010 CLEAN AIR PRODUCTS	Clean Air PRODUCTS	8605 WYOMING AVENUE NORTH • MINNEAPOLIS, MN 55445 800-423-9728 • ph: 763-425-9122 • fax: 763-425-2004 www.cleanairproducts.com		
	DESCRIPTION: Pass Thru - Wall Mount, Stainless Steel - CAP18W-SST-24Wx24Hx24D			
	QUOTE NO.			
DO NOT SCALE	DATE DRAWN 08/06/2010	QUOTE FORM 050141	REV 1	SHEET 1 of 2