

NOTES: UNLESS OTHERWISE SPECIFIED

1. DIMENSIONS ARE IN INCHES (mm).

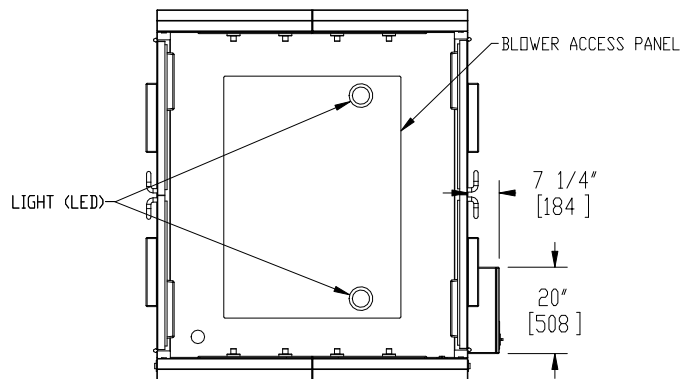
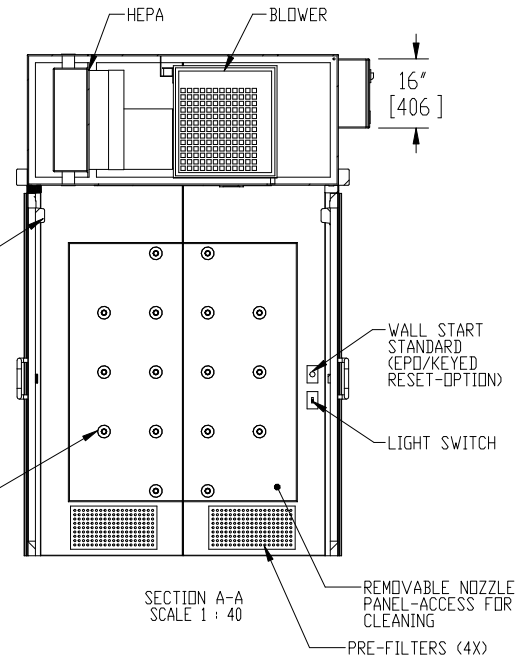
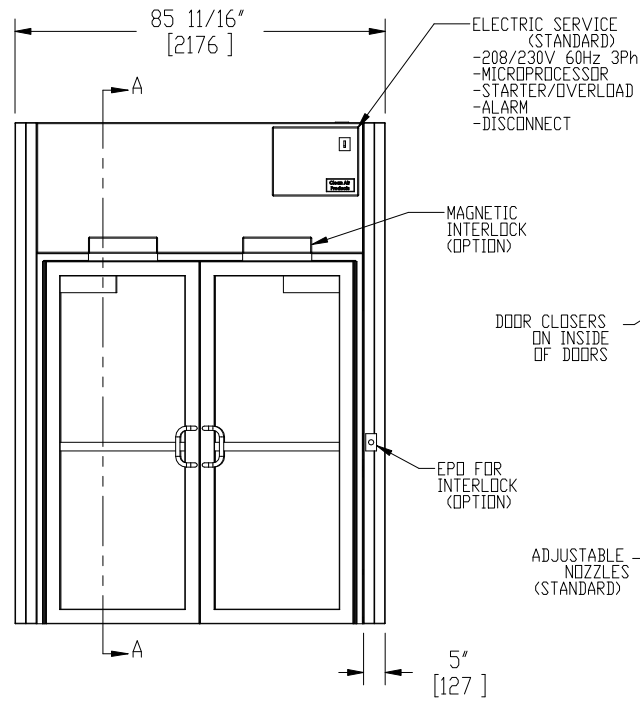
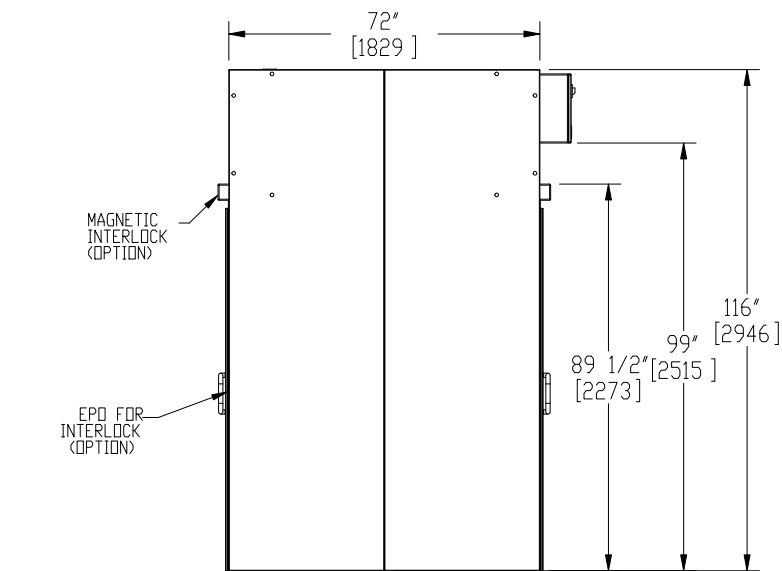
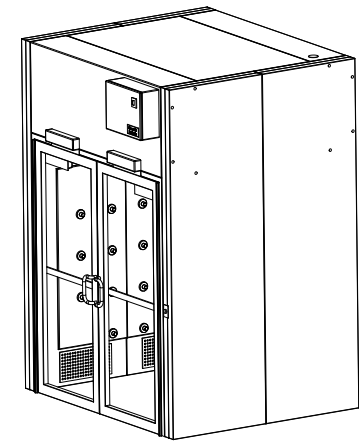
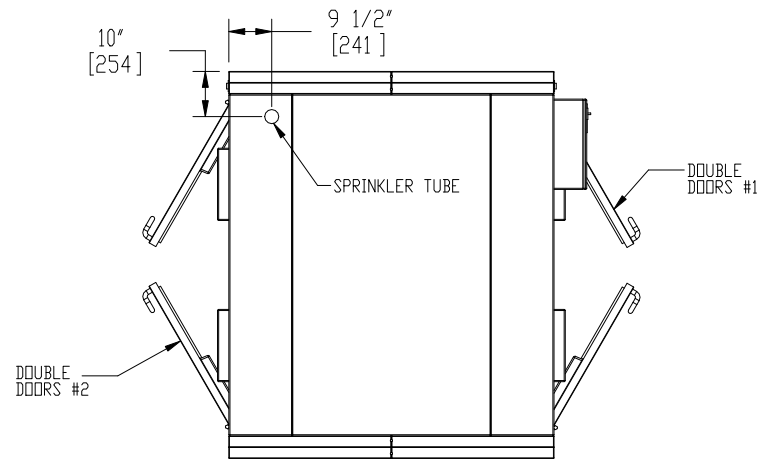

© COPYRIGHT 2010 CLEAN AIR PRODUCTS	Clean Air PRODUCTS 8605 WYOMING AVENUE NORTH • MINNEAPOLIS, MN 55445 800-423-9728 • ph: 763-425-9122 • fax: 763-425-2004 www.cleanairproducts.com
	DESCRIPTION. Air Shower - Straight Through CAP701KD-ST-8572
	QUOTE NO.
	DO NOT SCALE
DATE DRAWN 05/11/2010	QUOTE FORM 007968
REV 2	SHEET 1 of 3