

NOTES: UNLESS OTHERWISE SPECIFIED

1. DIMENSIONS ARE IN INCHES (mm).

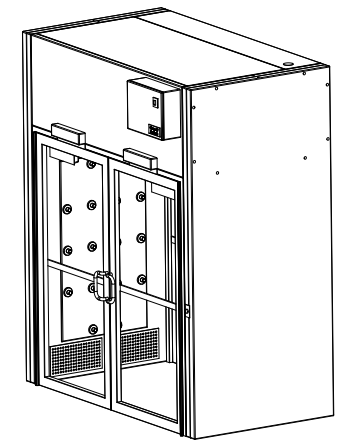
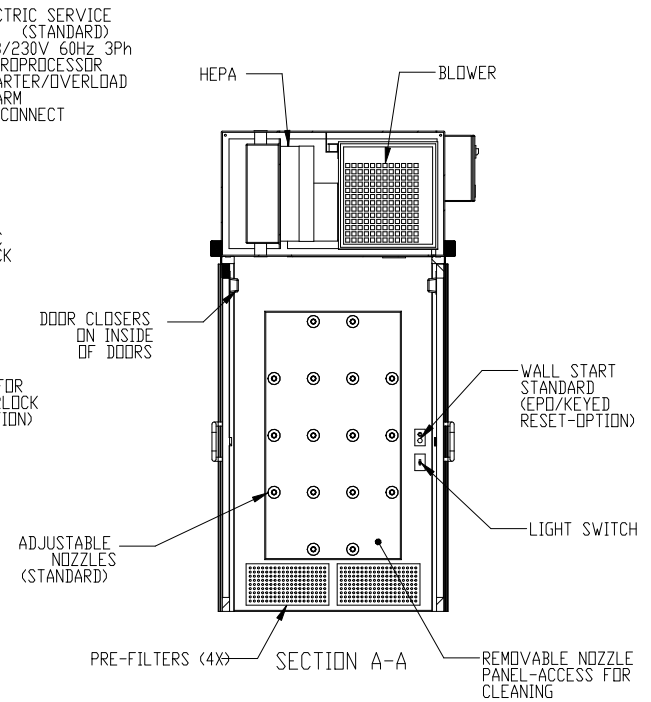
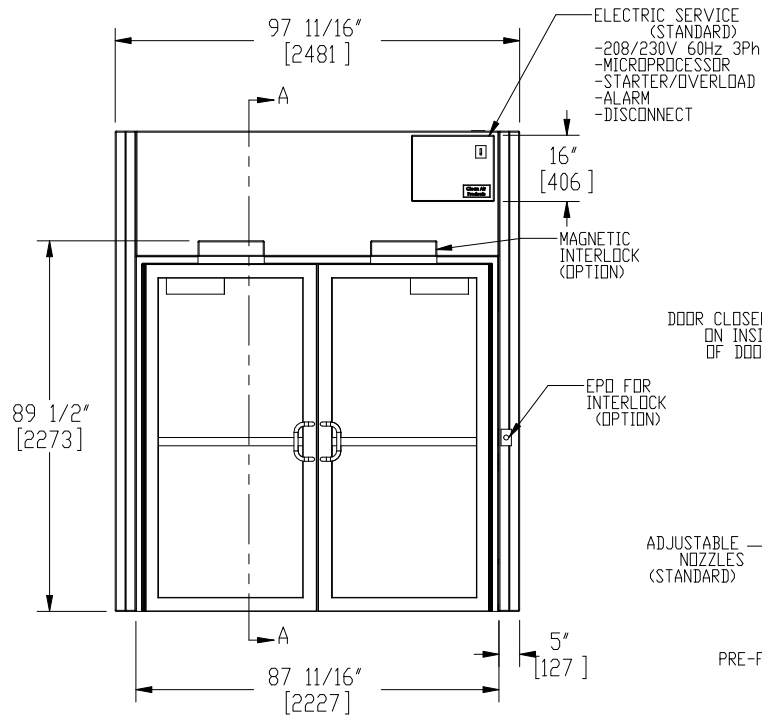
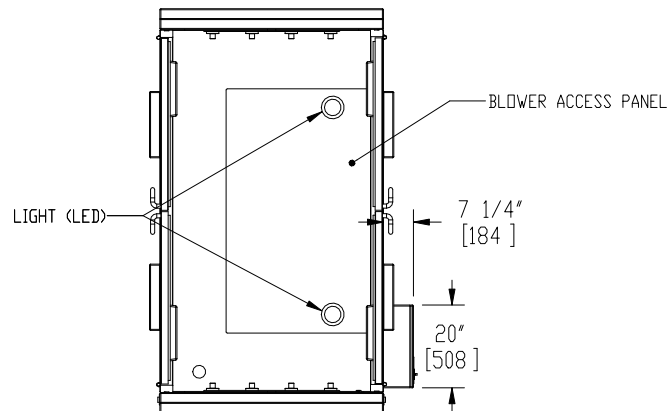
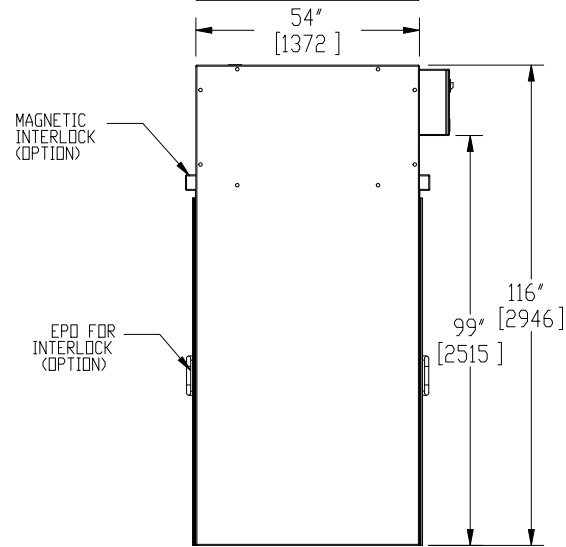
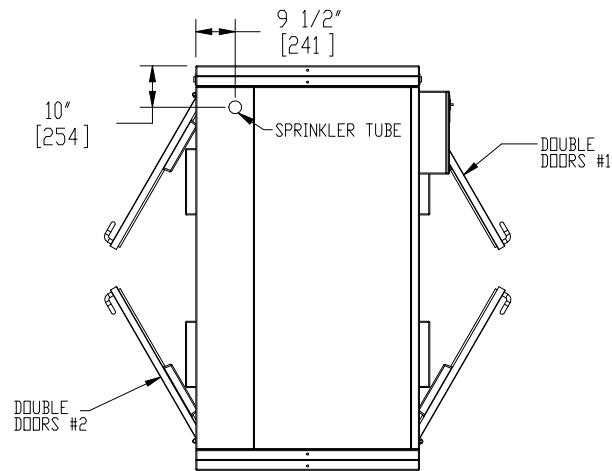

© COPYRIGHT 2010 CLEAN AIR PRODUCTS	Clean Air PRODUCTS 8605 WYOMING AVENUE NORTH • MINNEAPOLIS, MN 55445 800-423-9728 • ph: 763-425-9122 • fax: 763-425-2004 www.cleanairproducts.com			
	DESCRIPTION. Air Shower - Straight Through CAP701KD-ST-9754			
	QUOTE NO.			
DO NOT SCALE	DATE DRAWN 05/11/2010	QUOTE FORM 007969	REV 2	SHEET 1 of 3