

NOTES: UNLESS OTHERWISE SPECIFIED

1. DIMENSIONS ARE IN INCHES (mm).

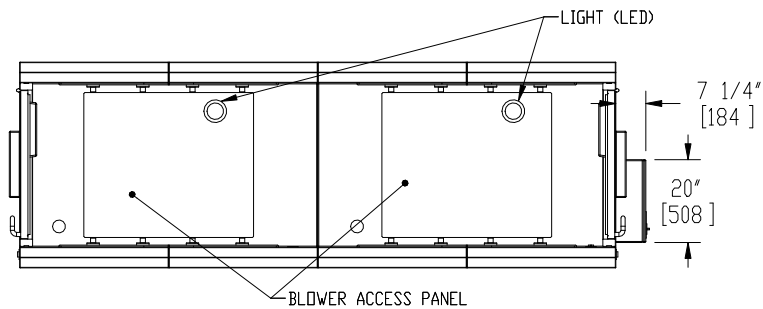
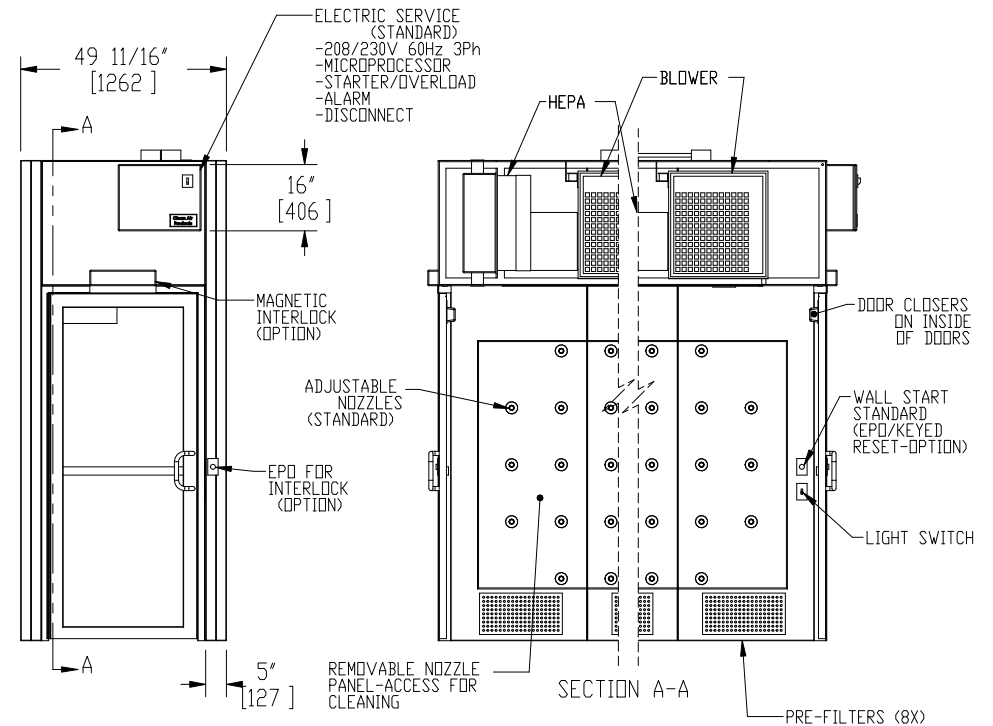
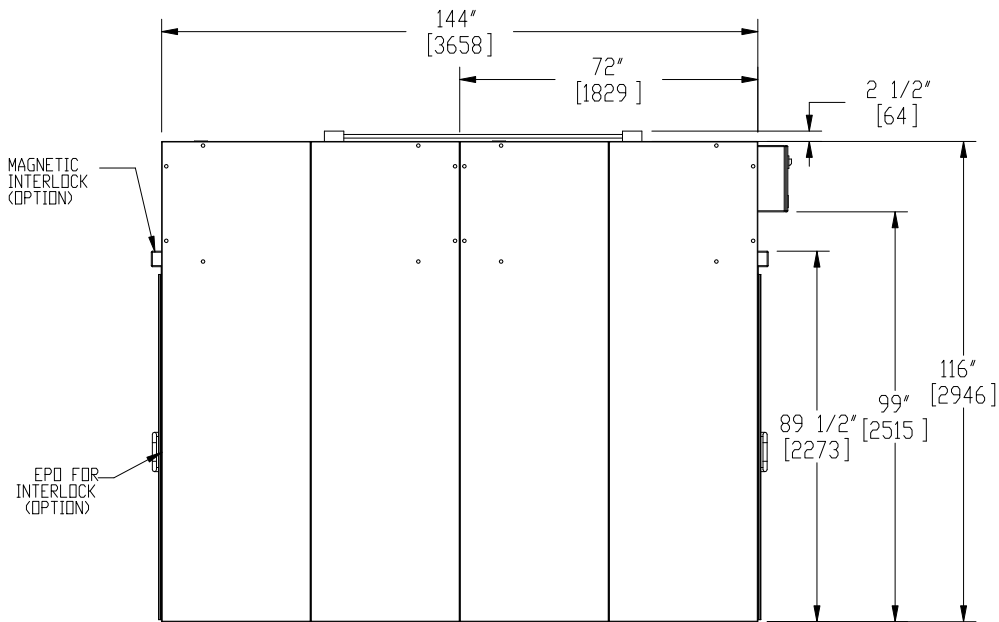
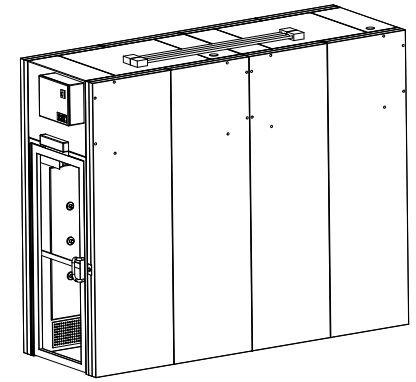
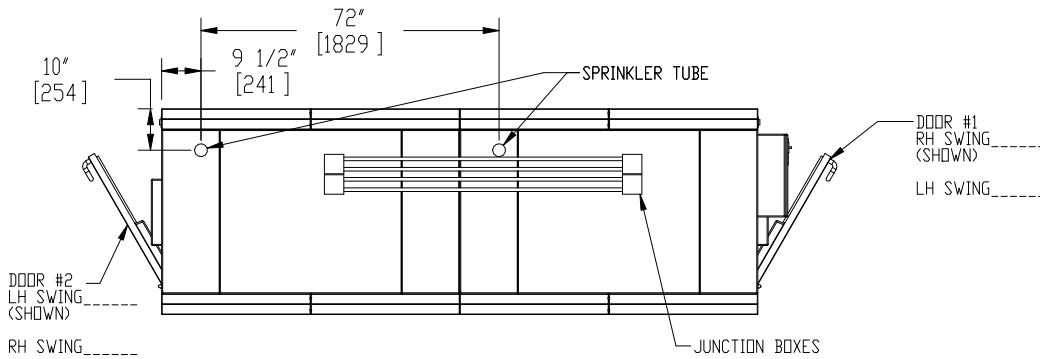

© COPYRIGHT 2010 CLEAN AIR PRODUCTS	Clean Air PRODUCTS 8605 WYOMING AVENUE NORTH • MINNEAPOLIS, MN 55445 800-423-9728 • ph: 763-425-9122 • fax: 763-425-2004 www.cleanairproducts.com			
	DESCRIPTION. Air Shower - Tunnel CAP701KD-ST2-49144			
	QUOTE NO.			
DO NOT SCALE	DATE DRAWN 12/23/2009	QUOTE FORM 004995	REV 2	SHEET 1 of 3