

NOTES: UNLESS OTHERWISE SPECIFIED

1. DIMENSIONS ARE IN INCHES (mm).

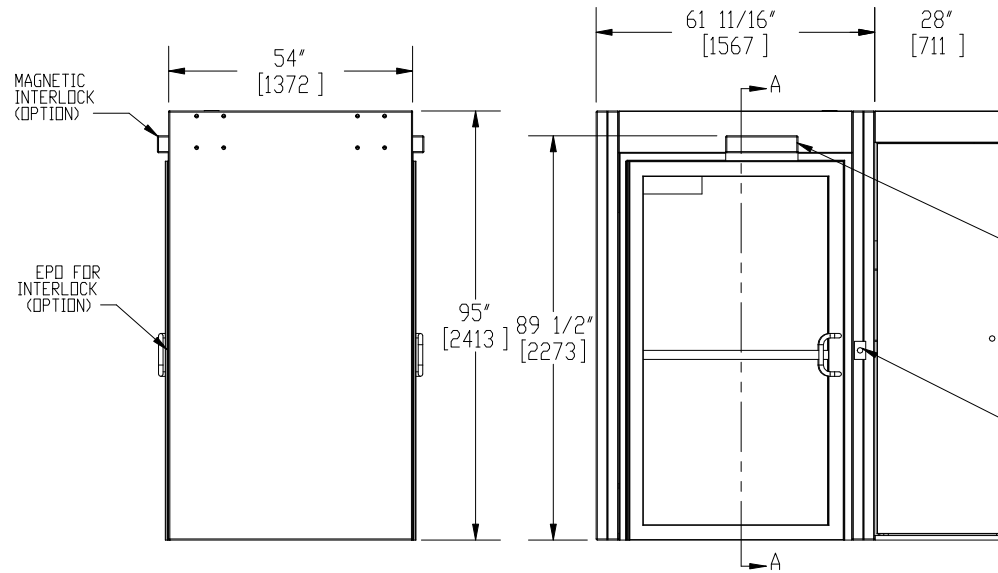

ELECTRIC SERVICE (STANDARD)
-208/230V 60Hz 3Ph
-MICROPROCESSOR
-STARTER/OVERLOAD
-ALARM
-DISCONNECT

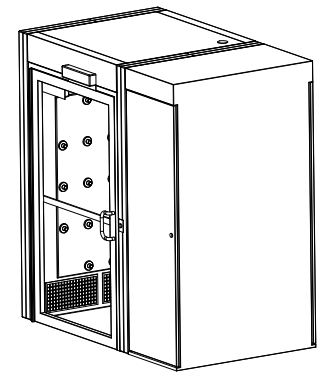
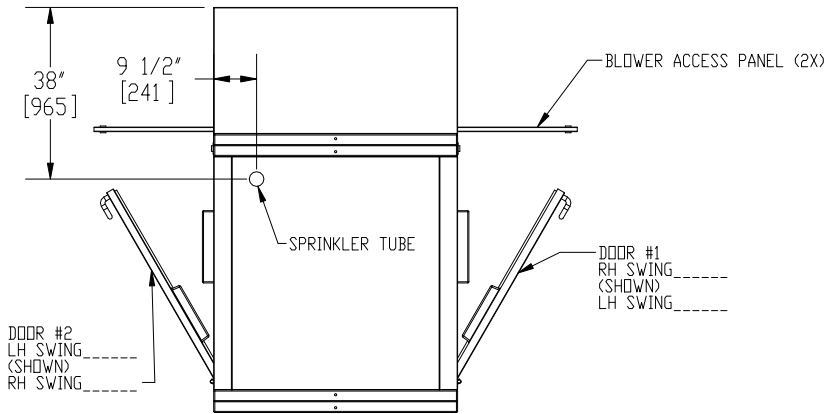
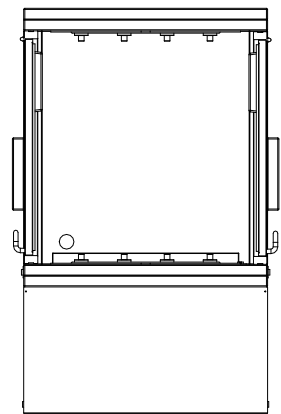
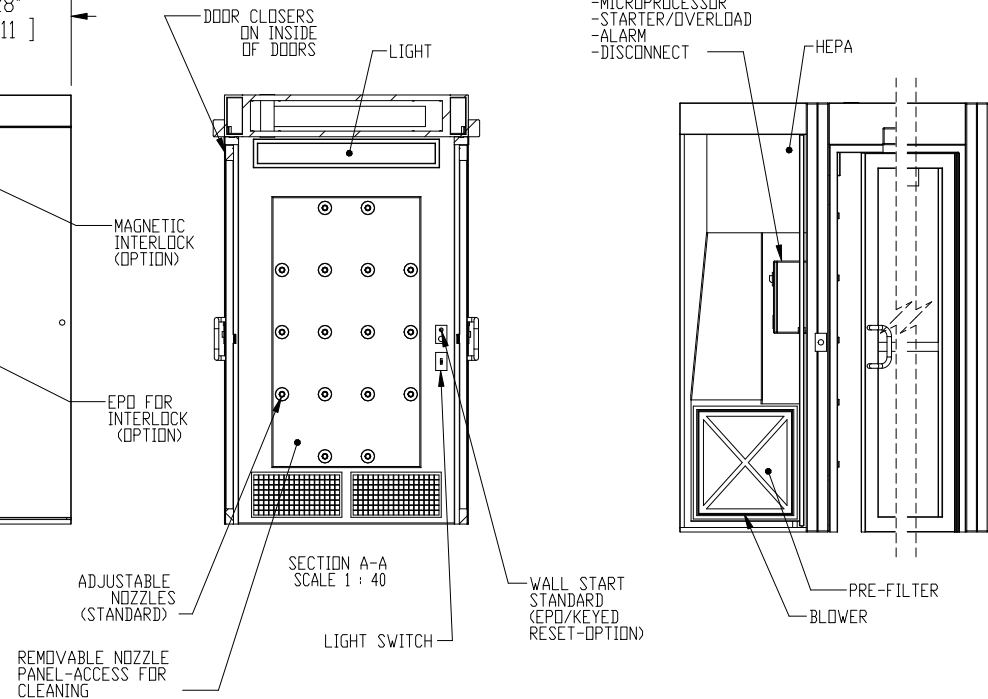

© COPYRIGHT 2010 CLEAN AIR PRODUCTS	Clean Air PRODUCTS	8605 WYOMING AVENUE NORTH 800-423-9728 • ph: 763-425-9122 • fax: 763-425-2004 www.cleanairproducts.com	• MINNEAPOLIS, MN 55445	
	DESCRIPTION.	Air Shower - Straight Through CAP701LP-ST-6154		
	QUOTE NO.			
DO NOT SCALE	DATE DRAWN 05/12/2010	QUOTE FORM 007993	REV 1	SHEET 1 of 3