

DOCUMENT HISTORY		
	DATE OF ORIGIN/RELEASE	05/22/2015
REV	DESCRIPTION OF REVISION	DATE

CONTENTS

DoorKing Model 6500 Swing Gate Elevation Drawings and Typical Lane Layouts with 4' Vehicle Loops for Normal Vehicles

Elevations Drawings
DoorKing Model 6500
Gate Style: Single-leaf Swing

Layout 1
DoorKing Model 6500
Gate Style: Single-leaf Swing
w/One-Way Entrance Drive
w/Access Device
w/Right-Hand Operator Mount
w/4' Loops for Normal Vehicles

Layout 2
DoorKing Model 6500
Gate Style: Single-leaf Swing
w/One-Way Entrance Drive
w/Access Device
w/Left-Hand Operator Mount
w/4' Loops for Normal Vehicles

Layout 3
DoorKing Model 6500
Gate Style: Single-leaf Swing
w/One-Way Free Exit Drive
w/Right-Hand Operator Mount
w/4' Loops for Normal Vehicles

Layout 4
DoorKing Model 6500
Gate Style: Single-leaf Swing
w/One-Way Drive
w/Free Exit
w/Left-Hand Operator Mount
w/4' Loops for Normal Vehicles

Layout 5
DoorKing Model 6500
Gate Style: Single-leaf Swing
w/Two-Way Drive
w/Entry & Exit Device
w/Right-Hand Operator Mount
w/4' Loops for Normal Vehicles

Layout 6
DoorKing Model 6500
Gate Style: Single-leaf Swing
w/Two-Way Drive
w/Entry & Exit Device
w/Left-Hand Operator Mount
w/4' Loops for Normal Vehicles

Layout 7
DoorKing Model 6500
Gate Style: Single-leaf Swing
w/Two-Way Drive
w/Entry Device & Free Exit
w/Right-Hand Operator Mount
w/4' Loops for Normal Vehicles

Layout 8
DoorKing Model 6500
Gate Style: Single-leaf Swing
w/Two-Way Drive
w/Entry Device & Free Exit
w/Left-Hand Operator Mount
w/4' Loops for Normal Vehicles

Layout 9
DoorKing Model 6500
Gate Style: Dual-leaf Swing
w/Two-Way Drive
w/Entry & Exit Device
w/Bi-parting Operator Mount
w/4' Loops for Normal Vehicles

Layout 10
DoorKing Model 6500
Gate Style: Dual-leaf Swing
w/Two-Way Drive
w/Entry & Exit Device
w/Bi-parting Operator Mount
w/4' Loops for Normal Vehicles

Layout 11
DoorKing Model 6500
Gate Style: Single-leaf Swing
w/One-Way Drive & Turn-around
w/Telephone Entry System
w/DoorKing Card Reader/Keypad
w/Right-hand Operator Mount
w/4' Loops for Normal Vehicles

Layout 12
DoorKing Model 6500
Gate Style: Single-leaf Swing
w/One-Way Drive & Off-set
Turn-around
w/Telephone Entry System
w/DoorKing Card Reader/Keypad
w/Left-hand Operator Mount
w/4' Loops for Normal Vehicles

GENERAL NOTES

- Automated vehicular gates shall be designed and installed to be in strict compliance with the UL 325 Safety Standard and the ASTM F2200 Construction Standard.
- Automated vehicular gates that do not meet the requirements of these standards shall not be allowed.
- This drawing is for the sole purpose of general gate operator foot-print and location, photo beam coverage and placement, and vehicular loop dimensions and placement. Drawings are not all inclusive or guaranteed to scale.
- No considerations have been made for grade, existing public utilities, landscape, drainage, site peculiarities, or requirements by the authority having jurisdiction, ie; Fire Marshall, Building Inspector, Street and Alley Departments.
- Warning Signs must be installed and must be highly visible upon both entry and exit of the property, and must remain in place for the life of the gate operating system.
- Proper lane identification and vehicular direction signs should be highly visible upon entry onto the property.
- Gate dimensions, posts, guide rollers, photo beams, reversing edges, hinges, and other gate hardware may vary in size, dimension, and placement and should not be used as an exact reference.
- All loop sizing and placement dimensions indicated are solely intended for reference only, and not intended to be the final criterion for determining the loop sizing and placement on any automated vehicular gate project. DoorKing, Inc does not assume responsibility or liability for any installation with regard to equipment/system malfunction, vehicle detector loop sizing and placement, or consequent damages or injuries caused thereby.
- DoorKing, Inc. does not assume responsibility or liability for the installation and unauthorized changes to the design and operation of equipment, or alterations to the final site plan.

CONTENTS

NTS
NOT TO SCALE

DKS®
DOORKING®

120 Glasgow Avenue
Inglewood, California 90301
Toll Free: 1-866-400-3600
Website: www.doorking.com
Email: ghendrix@doorking.com

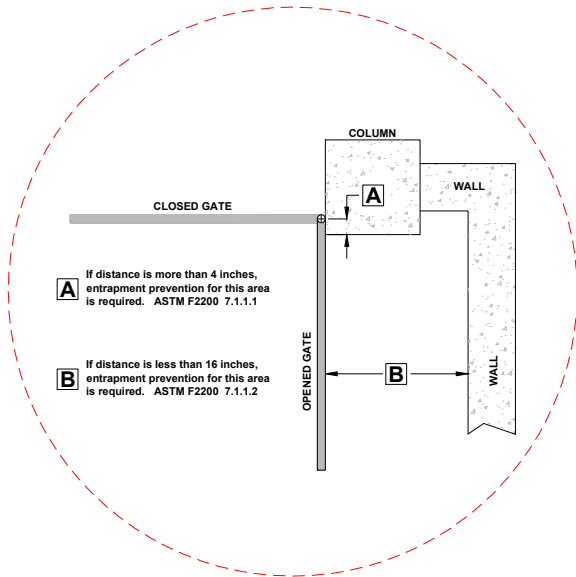

**ASTM F2200 7.1.1.1
&
ASTM F2200 7.1.1.2**

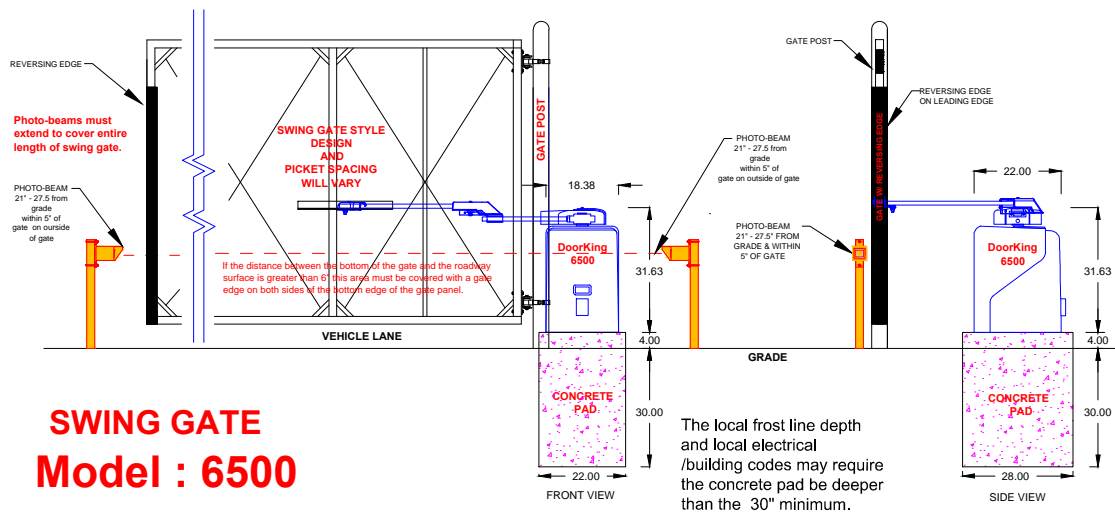

**SWING GATE
Model : 6500**

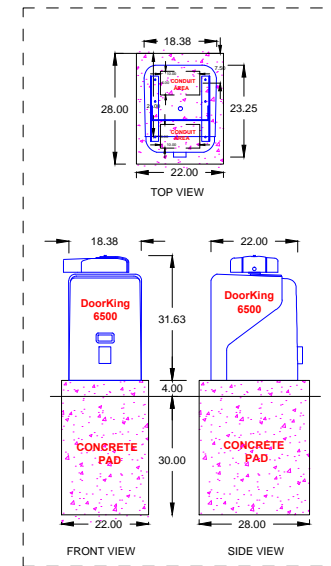

GENERAL NOTES

- Automated vehicular gates shall be designed and installed to be in strict compliance with the UL 325 Safety Standard and the ASTM F2200 Construction Standard.
- Automated vehicular gates that do not meet the requirements of these standards shall not be allowed.
- This drawing is for the sole purpose of general gate operator foot-print and location, photo beam coverage and placement, and vehicular loop dimensions and placement. Drawings are not all inclusive or guaranteed to scale.
- No considerations have been made for grade, existing public utilities, landscape, drainage, site peculiarities, or requirements by the authority having jurisdiction, ie; Fire Marshall, Building Inspector, Street and Alley Departments.
- Warning Signs must be installed and must be highly visible upon both entry and exit of the property, and must remain in place for the life of the gate operating system.
- Proper lane identification and vehicular direction signs should be highly visible upon entry onto the property.
- Gate dimensions, posts, guide rollers, photo beams, reversing edges, hinges, and other gate hardware may vary in size, dimension, and placement and should not be used as an exact reference.
- All loop sizing and placement dimensions indicated are solely intended for reference only, and not intended to be the final criterion for determining the loop sizing and placement on any automated vehicular gate project. DoorKing, Inc does not assume responsibility or liability for any installation with regard to equipment/system malfunction, vehicle detector loop sizing and placement, or consequent damages or injuries caused thereby.
- DoorKing, Inc. does not assume responsibility or liability for the installation and unauthorized changes to the design and operation of equipment, or alterations to the final site plan.

LAYOUT_DESCRIPTION

ELEVATION VIEWS

NTS
NOT TO SCALE

**DKS®
DOORKING®**

120 Glasgow Avenue
Inglewood, California 90301
Toll Free: 1-866-400-3600
Website: www.doorking.com
Email: ghendrix@doorking.com

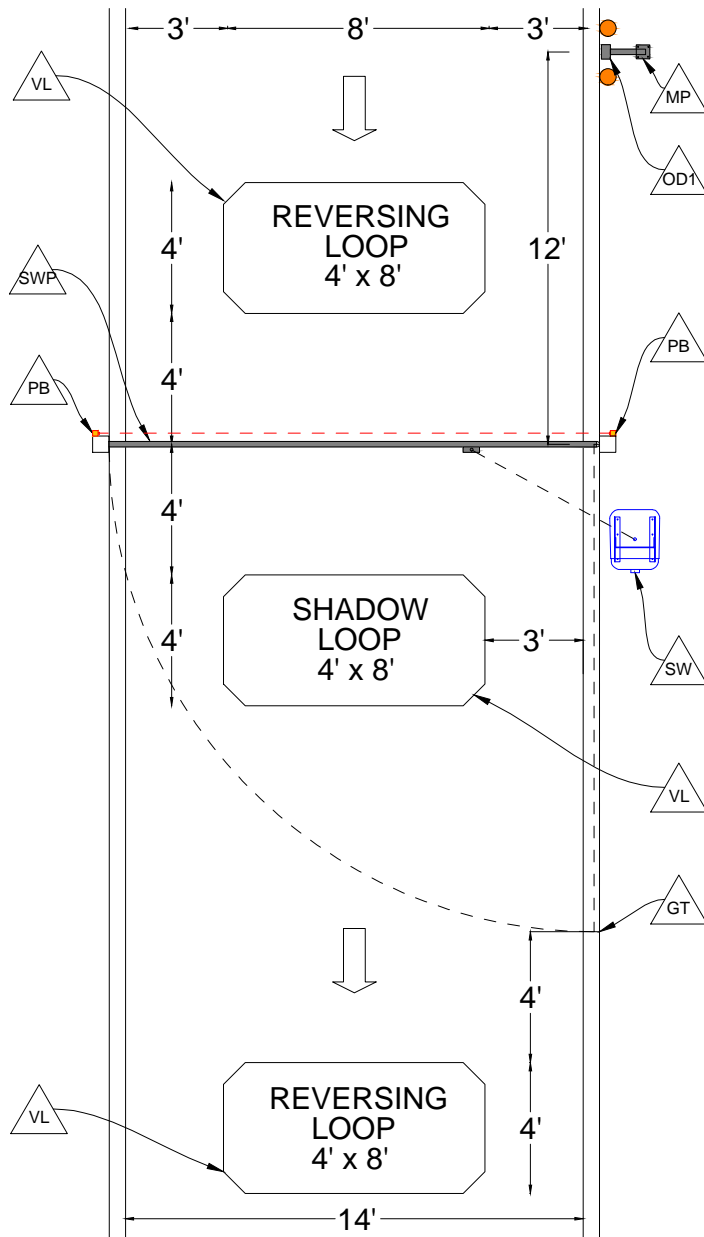

COMPONENTS	
SL	Slide Gate Operator:
SW	Swing Gate Operator: DoorKing Model 6500
PK	Parking Barrier Operator:
PB	Photo Beam: DoorKing Model 8080-031
RE	Reversing Edge: DoorKing Model 8080-0xx
VL	Vehicle Detecting Loop - DoorKing - Type 9402-xxx
OD1	Opening Device 1: DoorKing DKProx Card Reader
OD2	Opening Device 2:
OD3	Opening Device 3:
MP	Mounting Post: DoorKing Model 1200-xxx
SP	Slide Gate Panel
SWP	Swing Gate Panel
GT	Gate Travel
TS	Tail Section

- ### GENERAL NOTES
- Automated vehicular gates shall be designed and installed to be in strict compliance with the UL 325 Safety Standard and the ASTM F2200 Construction Standard.
 - Automated vehicular gates that do not meet the requirements of these standards shall not be allowed.
 - This drawing is for the sole purpose of general gate operator foot-print and location, photo beam coverage and placement, and vehicular loop dimensions and placement. Drawings are not all inclusive or guaranteed to scale.
 - No considerations have been made for grade, existing public utilities, landscape, drainage, site peculiarities, or requirements by the authority having jurisdiction, ie: Fire Marshall, Building Inspector, Street and Alley Departments.
 - Warning Signs must be installed and must be highly visible upon both entry and exit of the property, and must remain in place for the life of the gate operating system.
 - Proper lane identification and vehicular direction signs should be highly visible upon entry onto the property.
 - Gate dimensions, posts, guide rollers, photo beams, reversing edges, hinges, and other gate hardware may vary in size, dimension, and placement and should not be used as an exact reference.
 - All loop sizing and placement dimensions indicated are solely intended for reference only, and not intended to be the final criterion for determining the loop sizing and placement on any automated vehicular gate project. DoorKing, Inc does not assume responsibility or liability for any installation with regard to equipment/system malfunction, vehicle detector loop sizing and placement, or consequent damages or injuries caused thereby.
 - DoorKing, Inc. does not assume responsibility or liability for the installation and unauthorized changes to the design and operation of equipment, or alterations to the final site plan.

LAYOUT_DESCRIPTION:
Gate Style = Single-leaf Swinging
DoorKing Model 6500
w/ One-Way Drive
w/ Access Device
w/ Right-Hand Operator Mount
w/ 4' Loops for Normal Vehicles

Layout 1

LAYOUT_DESCRIPTION
LAYOUT 1
NTS NOT TO SCALE
DKS® DOOR KING®
120 Glasgow Avenue Inglewood, California 90301 Toll Free: 1-866-400-3600 Website: www.doorking.com Email: ghendrix@doorking.com

COMPONENTS

SL	Slide Gate Operator:
SW	Swing Gate Operator: DoorKing Model 6500
PK	Parking Barrier Operator:
PB	Photo Beam: DoorKing Model 8080-031
RE	Reversing Edge: DoorKing Model 8080-0xx
VL	Vehicle Detecting Loop - DoorKing - Type 9402-xxx
OD1	Opening Device 1: DoorKing DKProx Card Reader
OD2	Opening Device 2:
OD3	Opening Device 3:
MP	Mounting Post: DoorKing Model 1200-xxx
SP	Slide Gate Panel
SWP	Swing Gate Panel
GT	Gate Travel
TS	Tail Section

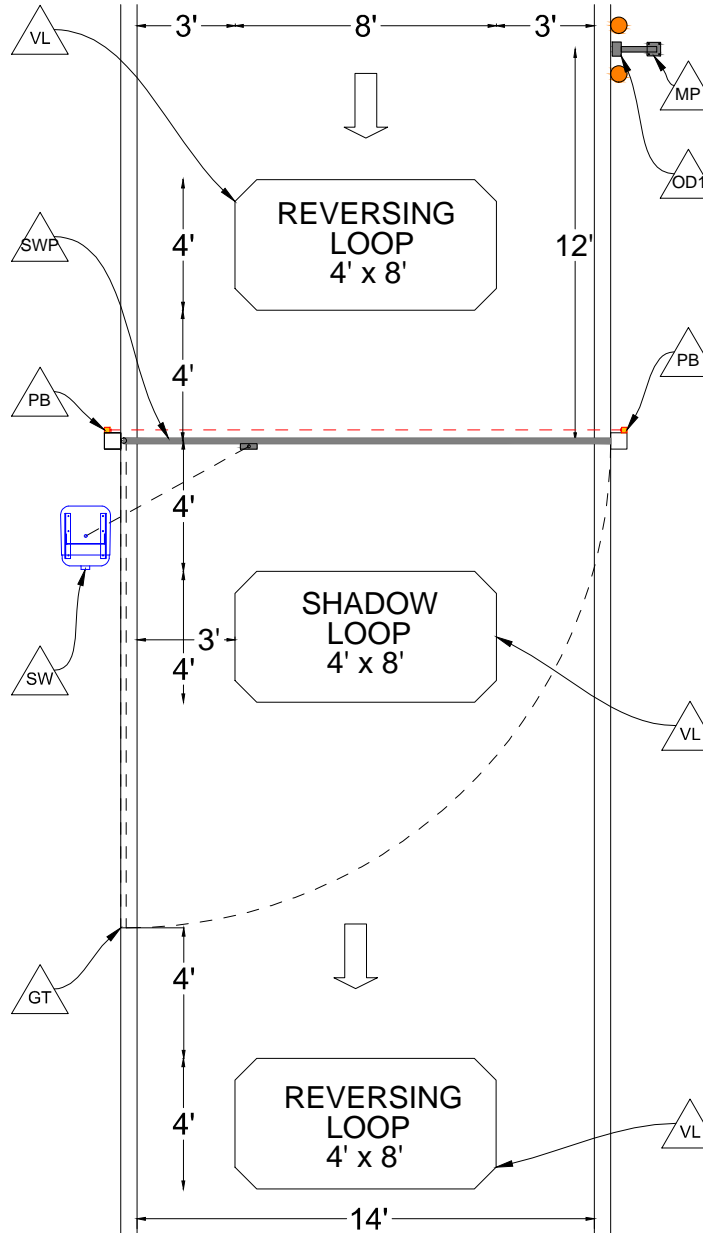

LAYOUT_DESCRIPTION:

Gate Style = Single-leaf Swinging

**DoorKing Model 6500
w/ One-Way Drive
w/ Access Device
w/ Left-Hand Operator Mount
w/ 4' Loops for Normal Vehicles**

Layout 2

GENERAL NOTES

- Automated vehicular gates shall be designed and installed to be in strict compliance with the UL 325 Safety Standard and the ASTM F2200 Construction Standard.
- Automated vehicular gates that do not meet the requirements of these standards shall not be allowed.
- This drawing is for the sole purpose of general gate operator foot-print and location, photo beam coverage and placement, and vehicular loop dimensions and placement. Drawings are not all inclusive or guaranteed to scale.
- No considerations have been made for grade, existing public utilities, landscape, drainage, site peculiarities, or requirements by the authority having jurisdiction, ie; Fire Marshall, Building Inspector, Street and Alley Departments.
- Warning Signs must be installed and must be highly visible upon both entry and exit of the property, and must remain in place for the life of the gate operating system.
- Proper lane identification and vehicular direction signs should be highly visible upon entry onto the property.
- Gate dimensions, posts, guide rollers, photo beams, reversing edges, hinges, and other gate hardware may vary in size, dimension, and placement and should not be used as an exact reference.
- All loop sizing and placement dimensions indicated are solely intended for reference only, and not intended to be the final criterion for determining the loop sizing and placement on any automated vehicular gate project. DoorKing, Inc does not assume responsibility or liability for any installation with regard to equipment/system malfunction, vehicle detector loop sizing and placement, or consequent damages or injuries caused thereby.
- DoorKing, Inc. does not assume responsibility or liability for the installation and unauthorized changes to the design and operation of equipment, or alterations to the final site plan.

LAYOUT_DESCRIPTION

LAYOUT 2

NTS
NOT TO SCALE

**DKS®
DOORKING®**

120 Glasgow Avenue
Inglewood, California 90301
Toll Free: 1-866-400-3600
Website: www.doorking.com
Email: ghendrix@doorking.com

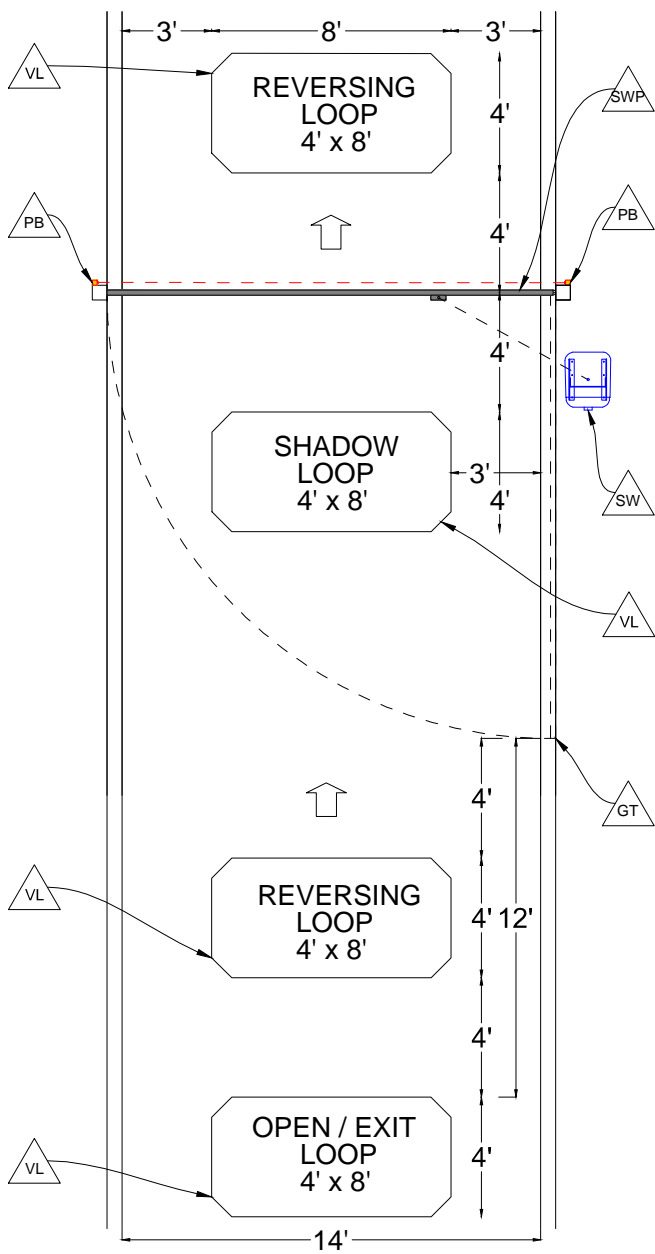

COMPONENTS	
SL	Slide Gate Operator:
SW	Swing Gate Operator: DoorKing Model 6500
PK	Parking Barrier Operator:
PB	Photo Beam: DoorKing Model 8080-031
RE	Reversing Edge: DoorKing Model 8080-0xx
VL	Vehicle Detecting Loop - DoorKing - Type 9402-xxx
OD1	Opening Device 1: DoorKing DKProx Card Reader
OD2	Opening Device 2:
OD3	Opening Device 3:
MP	Mounting Post: DoorKing Model 1200-xxx
SP	Slide Gate Panel
SWP	Swing Gate Panel
GT	Gate Travel
TS	Tail Section

- ### GENERAL NOTES
- Automated vehicular gates shall be designed and installed to be in strict compliance with the UL 325 Safety Standard and the ASTM F2200 Construction Standard.
 - Automated vehicular gates that do not meet the requirements of these standards shall not be allowed.
 - This drawing is for the sole purpose of general gate operator foot-print and location, photo beam coverage and placement, and vehicular loop dimensions and placement. Drawings are not all inclusive or guaranteed to scale.
 - No considerations have been made for grade, existing public utilities, landscape, drainage, site peculiarities, or requirements by the authority having jurisdiction, ie; Fire Marshall, Building Inspector, Street and Alley Departments.
 - Warning Signs must be installed and must be highly visible upon both entry and exit of the property, and must remain in place for the life of the gate operating system.
 - Proper lane identification and vehicular direction signs should be highly visible upon entry onto the property.
 - Gate dimensions, posts, guide rollers, photo beams, reversing edges, hinges, and other gate hardware may vary in size, dimension, and placement and should not be used as an exact reference.
 - All loop sizing and placement dimensions indicated are solely intended for reference only, and not intended to be the final criterion for determining the loop sizing and placement on any automated vehicular gate project. DoorKing, Inc does not assume responsibility or liability for any installation with regard to equipment/system malfunction, vehicle detector loop sizing and placement, or consequent damages or injuries caused thereby.
 - DoorKing, Inc. does not assume responsibility or liability for the installation and unauthorized changes to the design and operation of equipment, or alterations to the final site plan.

LAYOUT_DESCRIPTION:
Gate Style = Single-leaf Swinging
DoorKing Model 6500
w/ One-Way Drive
w/ Free Exit
w/ Right-Hand Operator Mount
w/ 4' Loops for Normal Vehicles

Layout 3

LAYOUT_DESCRIPTION
 LAYOUT 3

NTS
 NOT TO SCALE

DKS®
DOOR KING®

120 Glasgow Avenue
 Inglewood, California 90301
 Toll Free: 1-866-400-3600
 Website: www.doorking.com
 Email: ghendrix@doorking.com

COMPONENTS

SL	Slide Gate Operator:
SW	Swing Gate Operator: DoorKing Model 6500
PK	Parking Barrier Operator:
PB	Photo Beam: DoorKing Model 8080-031
RE	Reversing Edge: DoorKing Model 8080-0xx
VL	Vehicle Detecting Loop - DoorKing - Type 9402-xxx
OD1	Opening Device 1: DoorKing DKProx Card Reader
OD2	Opening Device 2:
OD3	Opening Device 3:
MP	Mounting Post: DoorKing Model 1200-xxx
SP	Slide Gate Panel
SWP	Swing Gate Panel
GT	Gate Travel
TS	Tail Section

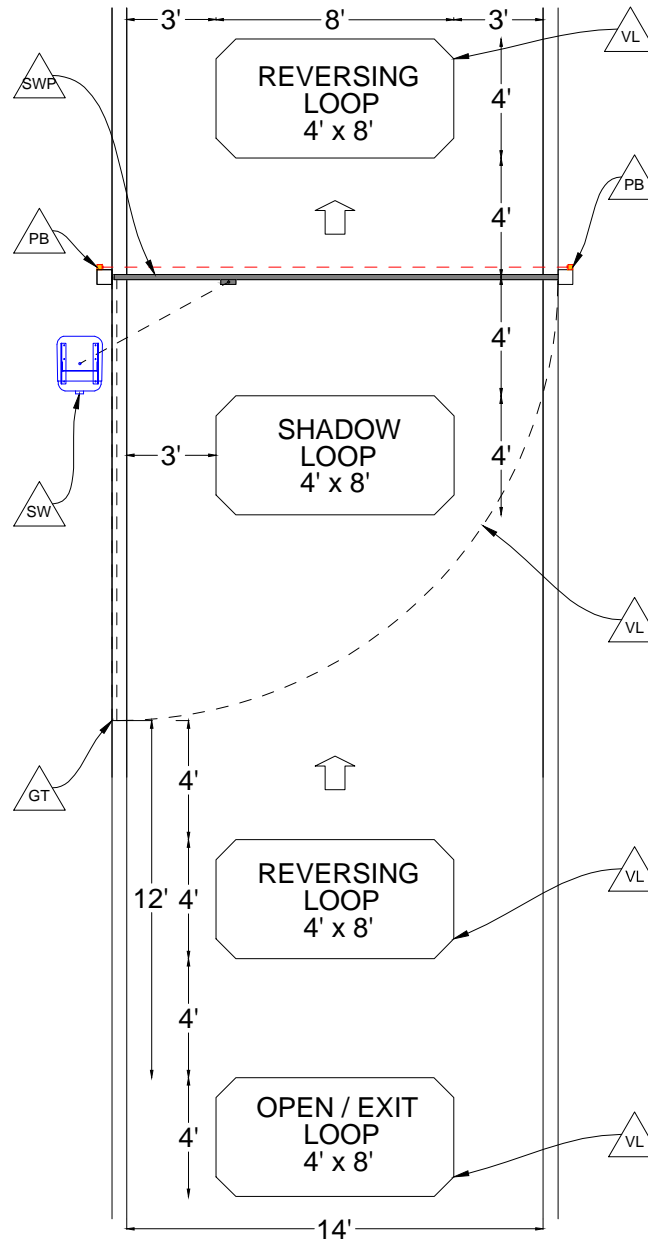

LAYOUT_DESCRIPTION:

Gate Style = Single-leaf Swinging

DoorKing Model 6500
w/ One-Way Drive
w/ Free Exit
w/ Left-Hand Operator Mount
w/ 4' Loops for Normal Vehicles

Layout 4

GENERAL NOTES

- Automated vehicular gates shall be designed and installed to be in strict compliance with the UL 325 Safety Standard and the ASTM F2200 Construction Standard.
- Automated vehicular gates that do not meet the requirements of these standards shall not be allowed.
- This drawing is for the sole purpose of general gate operator foot-print and location, photo beam coverage and placement, and vehicular loop dimensions and placement. Drawings are not all inclusive or guaranteed to scale.
- No considerations have been made for grade, existing public utilities, landscape, drainage, site peculiarities, or requirements by the authority having jurisdiction, ie: Fire Marshall, Building Inspector, Street and Alley Departments.
- Warning Signs must be installed and must be highly visible upon both entry and exit of the property, and must remain in place for the life of the gate operating system.
- Proper lane identification and vehicular direction signs should be highly visible upon entry onto the property.
- Gate dimensions, posts, guide rollers, photo beams, reversing edges, hinges, and other gate hardware may vary in size, dimension, and placement and should not be used as an exact reference.
- All loop sizing and placement dimensions indicated are solely intended for reference only, and not intended to be the final criterion for determining the loop sizing and placement on any automated vehicular gate project. DoorKing, Inc does not assume responsibility or liability for any installation with regard to equipment/system malfunction, vehicle detector loop sizing and placement, or consequent damages or injuries caused thereby.
- DoorKing, Inc. does not assume responsibility or liability for the installation and unauthorized changes to the design and operation of equipment, or alterations to the final site plan.

LAYOUT_DESCRIPTION

LAYOUT 4

NTS

NOT TO SCALE

DKS®
DOORKING®

120 Glasgow Avenue
Inglewood, California 90301
Toll Free: 1-866-400-3600
Website: www.doorking.com
Email: ghendrix@doorking.com

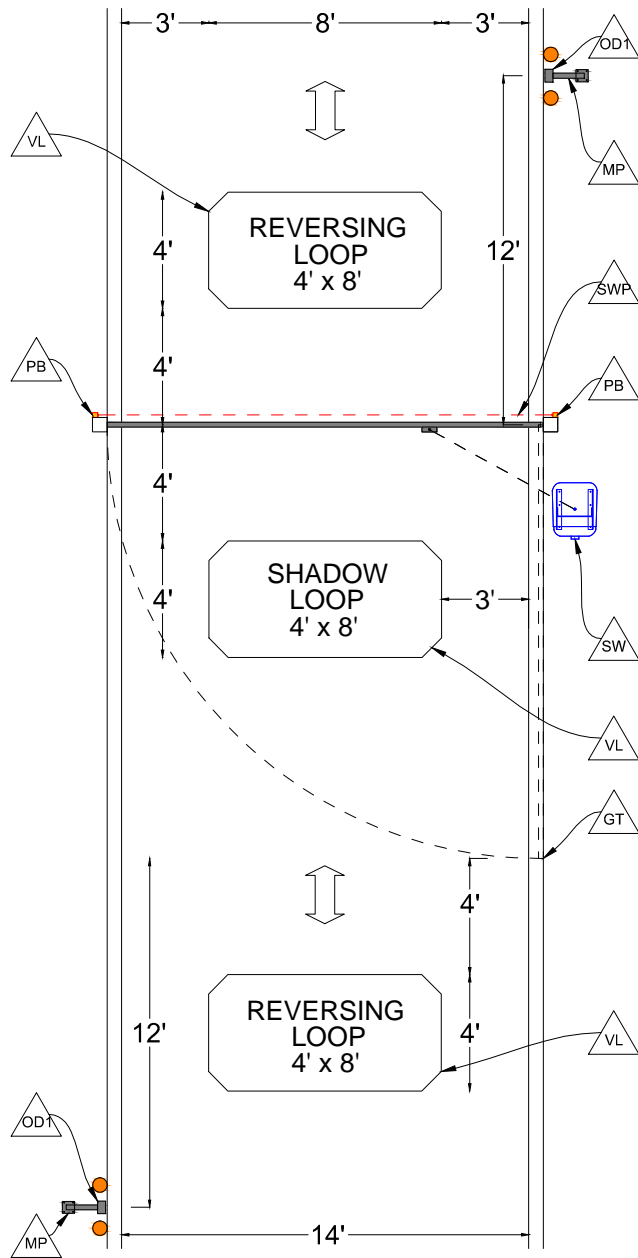

COMPONENTS	
SL	Slide Gate Operator:
SW	Swing Gate Operator: DoorKing Model 6500
PK	Parking Barrier Operator:
PB	Photo Beam: DoorKing Model 8080-031
RE	Reversing Edge: DoorKing Model 8080-0xx
VL	Vehicle Detecting Loop - DoorKing - Type 9402-xxx
OD1	Opening Device 1: DoorKing DKProx Card Reader
OD2	Opening Device 2:
OD3	Opening Device 3:
MP	Mounting Post: DoorKing Model 1200-xxx
SP	Slide Gate Panel
SWP	Swing Gate Panel
GT	Gate Travel
TS	Tail Section

- ### GENERAL NOTES
- Automated vehicular gates shall be designed and installed to be in strict compliance with the UL 325 Safety Standard and the ASTM F2200 Construction Standard.
 - Automated vehicular gates that do not meet the requirements of these standards shall not be allowed.
 - This drawing is for the sole purpose of general gate operator foot-print and location, photo beam coverage and placement, and vehicular loop dimensions and placement. Drawings are not all inclusive or guaranteed to scale.
 - No considerations have been made for grade, existing public utilities, landscape, drainage, site peculiarities, or requirements by the authority having jurisdiction, ie; Fire Marshall, Building Inspector, Street and Alley Departments.
 - Warning Signs must be installed and must be highly visible upon both entry and exit of the property, and must remain in place for the life of the gate operating system.
 - Proper lane identification and vehicular direction signs should be highly visible upon entry onto the property.
 - Gate dimensions, posts, guide rollers, photo beams, reversing edges, hinges, and other gate hardware may vary in size, dimension, and placement and should not be used as an exact reference.
 - All loop sizing and placement dimensions indicated are solely intended for reference only, and not intended to be the final criterion for determining the loop sizing and placement on any automated vehicular gate project. DoorKing, Inc does not assume responsibility or liability for any installation with regard to equipment/system malfunction, vehicle detector loop sizing and placement, or consequent damages or injuries caused thereby.
 - DoorKing, Inc. does not assume responsibility or liability for the installation and unauthorized changes to the design and operation of equipment, or alterations to the final site plan.

LAYOUT_DESCRIPTION:
Gate Style = Single-leaf Swinging
DoorKing Model 6500
w/ Two-Way Drive
w/ Right-Hand Operator Mount
w/ 4' Loops for Normal Vehicles

Layout 5

LAYOUT_DESCRIPTION

LAYOUT 5

NTS
 NOT TO SCALE

DKS®
DOORKING®

120 Glasgow Avenue
 Inglewood, California 90301
 Toll Free: 1-866-400-3600
 Website: www.doorking.com
 Email: ghendrix@doorking.com

COMPONENTS

SL	Slide Gate Operator:
SW	Swing Gate Operator: DoorKing Model 6500
PK	Parking Barrier Operator:
PB	Photo Beam: DoorKing Model 8080-031
RE	Reversing Edge: DoorKing Model 8080-0xx
VL	Vehicle Detecting Loop - DoorKing - Type 9402-xxx
OD1	Opening Device 1: DoorKing DKProx Card Reader
OD2	Opening Device 2:
OD3	Opening Device 3:
MP	Mounting Post: DoorKing Model 1200-xxx
SP	Slide Gate Panel
SWP	Swing Gate Panel
GT	Gate Travel
TS	Tail Section

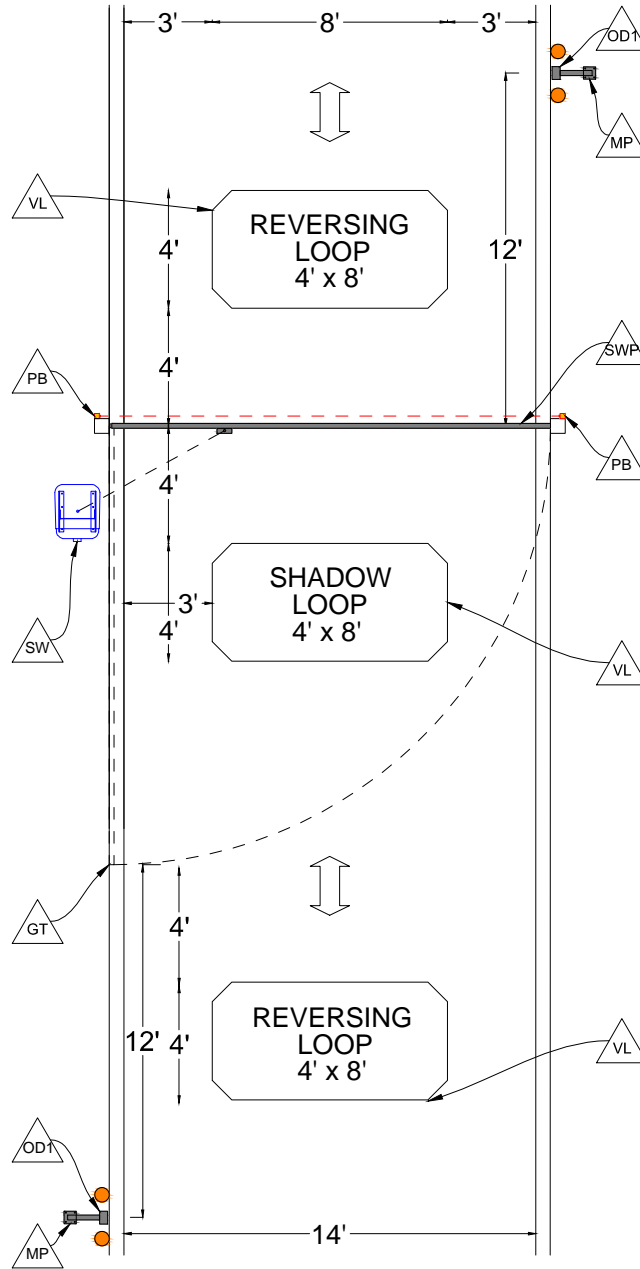

LAYOUT_DESCRIPTION:

Gate Style = Single-leaf Swinging

DoorKing Model 6500
w/ Two-Way Drive
w/ Entry & Exit Device
w/ Left-Hand Operator Mount
w/ 4' Loops for Normal Vehicles

Layout 6

GENERAL NOTES

- Automated vehicular gates shall be designed and installed to be in strict compliance with the UL 325 Safety Standard and the ASTM F2200 Construction Standard.
- Automated vehicular gates that do not meet the requirements of these standards shall not be allowed.
- This drawing is for the sole purpose of general gate operator foot-print and location, photo beam coverage and placement, and vehicular loop dimensions and placement. Drawings are not all inclusive or guaranteed to scale.
- No considerations have been made for grade, existing public utilities, landscape, drainage, site peculiarities, or requirements by the authority having jurisdiction, ie: Fire Marshall, Building Inspector, Street and Alley Departments.
- Warning Signs must be installed and must be highly visible upon both entry and exit of the property, and must remain in place for the life of the gate operating system.
- Proper lane identification and vehicular direction signs should be highly visible upon entry onto the property.
- Gate dimensions, posts, guide rollers, photo beams, reversing edges, hinges, and other gate hardware may vary in size, dimension, and placement and should not be used as an exact reference.
- All loop sizing and placement dimensions indicated are solely intended for reference only, and not intended to be the final criterion for determining the loop sizing and placement on any automated vehicular gate project. DoorKing, Inc does not assume responsibility or liability for any installation with regard to equipment/system malfunction, vehicle detector loop sizing and placement, or consequent damages or injuries caused thereby.
- DoorKing, Inc. does not assume responsibility or liability for the installation and unauthorized changes to the design and operation of equipment, or alterations to the final site plan.

LAYOUT_DESCRIPTION

LAYOUT 6

NTS

NOT TO SCALE

DKS®
DOORKING®

120 Glasgow Avenue
Inglewood, California 90301
Toll Free: 1-866-400-3600
Website: www.doorking.com
Email: ghendrix@doorking.com

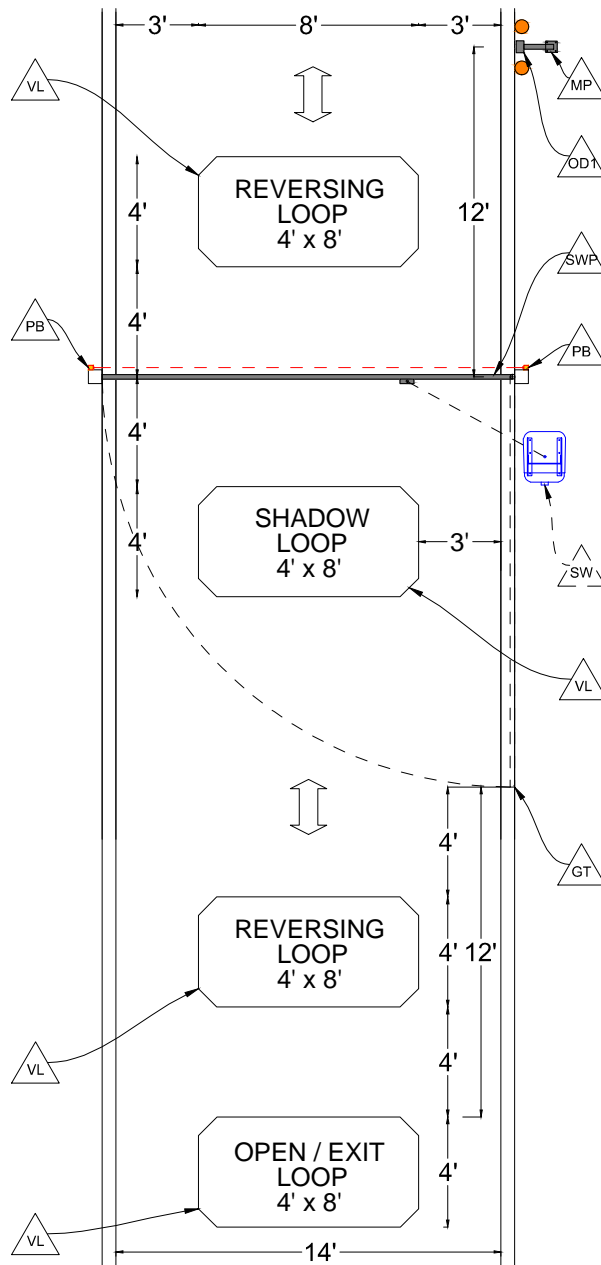

COMPONENTS	
SL	Slide Gate Operator:
SW	Swing Gate Operator: DoorKing Model 6500
PK	Parking Barrier Operator:
PB	Photo Beam: DoorKing Model 8080-031
RE	Reversing Edge: DoorKing Model 8080-0xx
VL	Vehicle Detecting Loop - DoorKing - Type 9402-xxx
OD1	Opening Device 1: DoorKing DKProx Card Reader
OD2	Opening Device 2:
OD3	Opening Device 3:
MP	Mounting Post: DoorKing Model 1200-xxx
SP	Slide Gate Panel
SWP	Swing Gate Panel
GT	Gate Travel
TS	Tail Section

- ### GENERAL NOTES
- Automated vehicular gates shall be designed and installed to be in strict compliance with the UL 325 Safety Standard and the ASTM F2200 Construction Standard.
 - Automated vehicular gates that do not meet the requirements of these standards shall not be allowed.
 - This drawing is for the sole purpose of general gate operator foot-print and location, photo beam coverage and placement, and vehicular loop dimensions and placement. Drawings are not all inclusive or guaranteed to scale.
 - No considerations have been made for grade, existing public utilities, landscape, drainage, site peculiarities, or requirements by the authority having jurisdiction, ie; Fire Marshall, Building Inspector, Street and Alley Departments.
 - Warning Signs must be installed and must be highly visible upon both entry and exit of the property, and must remain in place for the life of the gate operating system.
 - Proper lane identification and vehicular direction signs should be highly visible upon entry onto the property.
 - Gate dimensions, posts, guide rollers, photo beams, reversing edges, hinges, and other gate hardware may vary in size, dimension, and placement and should not be used as an exact reference.
 - All loop sizing and placement dimensions indicated are solely intended for reference only, and not intended to be the final criterion for determining the loop sizing and placement on any automated vehicular gate project. DoorKing, Inc does not assume responsibility or liability for any installation with regard to equipment/system malfunction, vehicle detector loop sizing and placement, or consequent damages or injuries caused thereby.
 - DoorKing, Inc. does not assume responsibility or liability for the installation and unauthorized changes to the design and operation of equipment, or alterations to the final site plan.

LAYOUT_DESCRIPTION:
Gate Style = Single-leaf Swinging
DoorKing Model 6500
w/ Two-Way Drive
w/ Entry Device & Free Exit
w/ Right-Hand Operator Mount
w/ 4' Loops for Normal Vehicles

Layout 7

LAYOUT_DESCRIPTION
 LAYOUT 7

NTS
 NOT TO SCALE

DKS®
DOORKING®

120 Glasgow Avenue
 Inglewood, California 90301
 Toll Free: 1-866-400-3600
 Website: www.doorking.com
 Email: ghendrix@doorking.com

COMPONENTS

SL	Slide Gate Operator:
SW	Swing Gate Operator: DoorKing Model 6500
PK	Parking Barrier Operator:
PB	Photo Beam: DoorKing Model 8080-031
RE	Reversing Edge: DoorKing Model 8080-0xx
VL	Vehicle Detecting Loop - DoorKing - Type 9402-xxx
OD1	Opening Device 1: DoorKing DKProx Card Reader
OD2	Opening Device 2:
OD3	Opening Device 3:
MP	Mounting Post: DoorKing Model 1200-xxx
SP	Slide Gate Panel
SWP	Swing Gate Panel
GT	Gate Travel
TS	Tail Section

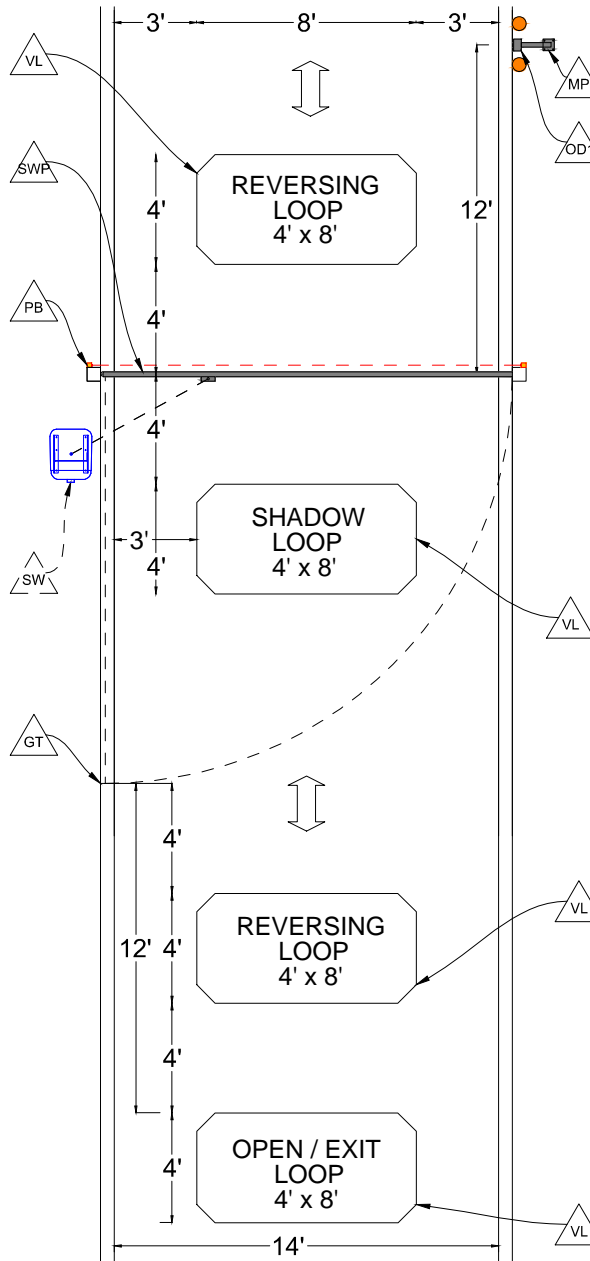

LAYOUT_DESCRIPTION:

Gate Style = Single-leaf Swinging

DoorKing Model 6500
w/ Two-Way Drive
w/ Entry Device & Free Exit
w/ Left-Hand Operator Mount
w/ 4' Loops for Normal Vehicles

Layout 8

GENERAL NOTES

- Automated vehicular gates shall be designed and installed to be in strict compliance with the UL 325 Safety Standard and the ASTM F2200 Construction Standard.
- Automated vehicular gates that do not meet the requirements of these standards shall not be allowed.
- This drawing is for the sole purpose of general gate operator foot-print and location, photo beam coverage and placement, and vehicular loop dimensions and placement. Drawings are not all inclusive or guaranteed to scale.
- No considerations have been made for grade, existing public utilities, landscape, drainage, site peculiarities, or requirements by the authority having jurisdiction, i.e. Fire Marshall, Building Inspector, Street and Alley Departments.
- Warning Signs must be installed and must be highly visible upon both entry and exit of the property, and must remain in place for the life of the gate operating system.
- Proper lane identification and vehicular direction signs should be highly visible upon entry onto the property.
- Gate dimensions, posts, guide rollers, photo beams, reversing edges, hinges, and other gate hardware may vary in size, dimension, and placement and should not be used as an exact reference.
- All loop sizing and placement dimensions indicated are solely intended for reference only, and not intended to be the final criterion for determining the loop sizing and placement on any automated vehicular gate project. DoorKing, Inc. does not assume responsibility or liability for any installation with regard to equipment/system malfunction, vehicle detector loop sizing and placement, or consequent damages or injuries caused thereby.
- DoorKing, Inc. does not assume responsibility or liability for the installation and unauthorized changes to the design and operation of equipment, or alterations to the final site plan.

LAYOUT_DESCRIPTION

LAYOUT 8

NTS

NOT TO SCALE

DKS®
DOORKING®

120 Glasgow Avenue
Inglewood, California 90301
Toll Free: 1-866-400-3600
Website: www.doorking.com
Email: ghendrix@doorking.com

COMPONENTS

SL	Slide Gate Operator:
SW	Swing Gate Operator: DoorKing Model 6500
PK	Parking Barrier Operator:
PB	Photo Beam: DoorKing Model 8080-031
RE	Reversing Edge: DoorKing Model 8080-0xx
VL	Vehicle Detecting Loop - DoorKing - Type 9402-xxx
OD1	Opening Device 1: DoorKing DKProx Card Reader
OD2	Opening Device 2:
OD3	Opening Device 3:
MP	Mounting Post: DoorKing Model 1200-xxx
SP	Slide Gate Panel
SWP	Swing Gate Panel
GT	Gate Travel
TS	Tail Section

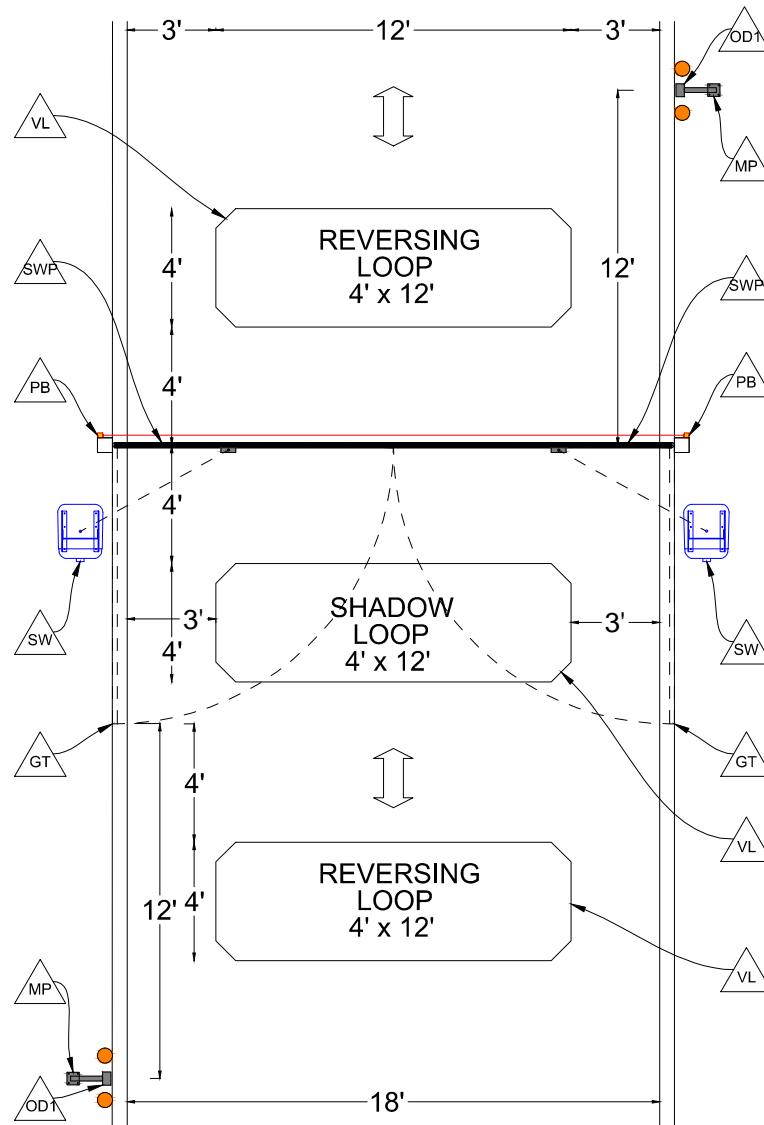

LAYOUT_DESCRIPTION:

Gate Style = Dual-leaf Swinging

DoorKing Model 6500
w/ Two-Way Drive
w/ Entry & Exit Device
w/ Bi-parting Operator Mount
w/ 4' Loops for Normal Vehicles

Layout 9

GENERAL NOTES

- Automated vehicular gates shall be designed and installed to be in strict compliance with the UL 325 Safety Standard and the ASTM F2200 Construction Standard.
- Automated vehicular gates that do not meet the requirements of these standards shall not be allowed.
- This drawing is for the sole purpose of general gate operator foot-print and location, photo beam coverage and placement, and vehicular loop dimensions and placement. Drawings are not all inclusive or guaranteed to scale.
- No considerations have been made for grade, existing public utilities, landscape, drainage, site peculiarities, or requirements by the authority having jurisdiction, i.e. Fire Marshall, Building Inspector, Street and Alley Departments.
- Warning Signs must be installed and must be highly visible upon both entry and exit of the property, and must remain in place for the life of the gate operating system.
- Proper lane identification and vehicular direction signs should be highly visible upon entry onto the property.
- Gate dimensions, posts, guide rollers, photo beams, reversing edges, hinges, and other gate hardware may vary in size, dimension, and placement and should not be used as an exact reference.
- All loop sizing and placement dimensions indicated are solely intended for reference only, and not intended to be the final criterion for determining the loop sizing and placement on any automated vehicular gate project. DoorKing, Inc does not assume responsibility or liability for any installation with regard to equipment/system malfunction, vehicle detector loop sizing and placement, or consequent damages or injuries caused thereby.
- DoorKing, Inc. does not assume responsibility or liability for the installation and unauthorized changes to the design and operation of equipment, or alterations to the final site plan.

LAYOUT_DESCRIPTION

LAYOUT 9

NTS
NOT TO SCALE

DKS®
DOOR KING®

120 Glasgow Avenue
Inglewood, California 90301
Toll Free: 1-866-400-3600
Website: www.doorking.com
Email: ghendrix@doorking.com

COMPONENTS	
SL	Slide Gate Operator:
SW	Swing Gate Operator: DoorKing Model 6500
PK	Parking Barrier Operator:
PB	Photo Beam: DoorKing Model 8080-031
RE	Reversing Edge: DoorKing Model 8080-0xx
VL	Vehicle Detecting Loop - DoorKing - Type 9402-xxx
OD1	Opening Device 1: DoorKing DKProx Card Reader
OD2	Opening Device 2:
OD3	Opening Device 3:
MP	Mounting Post: DoorKing Model 1200-xxx
SP	Slide Gate Panel
SWP	Swing Gate Panel
GT	Gate Travel
TS	Tail Section

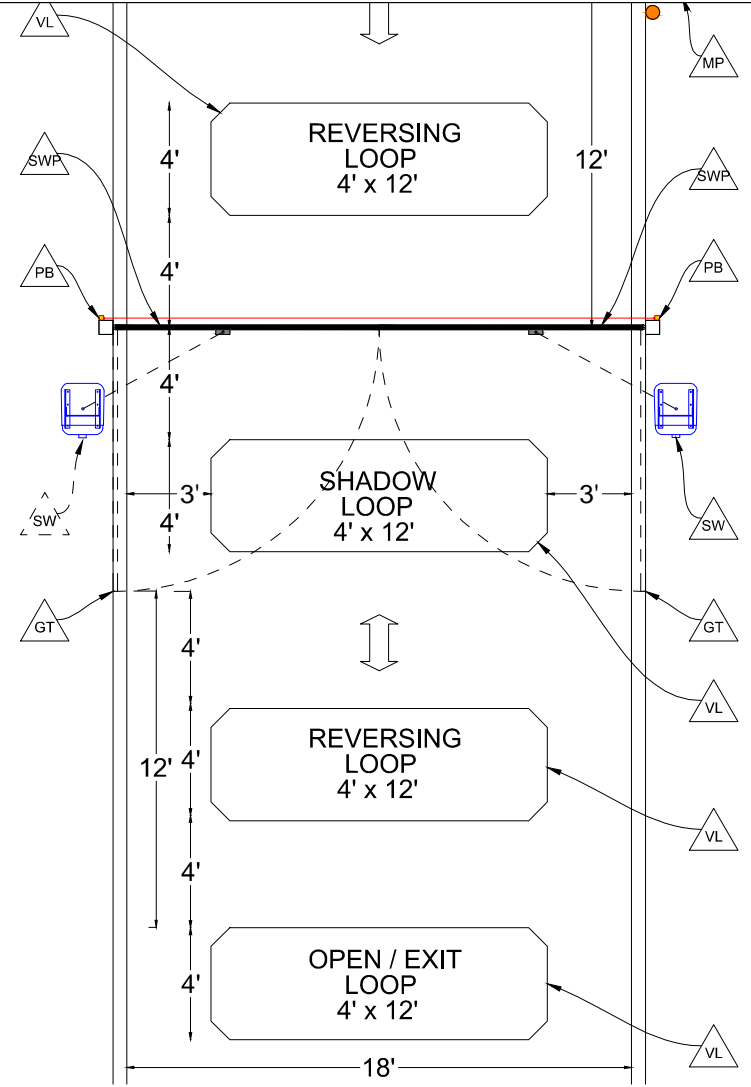

LAYOUT_DESCRIPTION:

Gate Style = Dual-leaf Swinging
 DoorKing Model 6500
 w/ Two-Way Drive
 w/ Entry & Exit Device
 w/ Bi-parting Operator Mount
 w/ 4' Loops for Normal Vehicles

Layout 10

GENERAL NOTES

- Automated vehicular gates shall be designed and installed to be in strict compliance with the UL 325 Safety Standard and the ASTM F2200 Construction Standard.
- Automated vehicular gates that do not meet the requirements of these standards shall not be allowed.
- This drawing is for the sole purpose of general gate operator foot-print and location, photo beam coverage and placement, and vehicular loop dimensions and placement. Drawings are not all inclusive or guaranteed to scale.
- No considerations have been made for grade, existing public utilities, landscape, drainage, site peculiarities, or requirements by the authority having jurisdiction, i.e. Fire Marshall, Building Inspector, Street and Alley Departments.
- Warning Signs must be installed and must be highly visible upon both entry and exit of the property, and must remain in place for the life of the gate operating system.
- Proper lane identification and vehicular direction signs should be highly visible upon entry onto the property.
- Gate dimensions, posts, guide rollers, photo beams, reversing edges, hinges, and other gate hardware may vary in size, dimension, and placement and should not be used as an exact reference.
- All loop sizing and placement dimensions indicated are solely intended for reference only, and not intended to be the final criterion for determining the loop sizing and placement on any automated vehicular gate project. DoorKing, Inc. does not assume responsibility or liability for any installation with regard to equipment/system malfunction, vehicle detector loop sizing and placement, or consequent damages or injuries caused thereby.
- DoorKing, Inc. does not assume responsibility or liability for the installation and unauthorized changes to the design and operation of equipment, or alterations to the final site plan.

LAYOUT_DESCRIPTION

LAYOUT 10

NTS
 NOT TO SCALE

**DKS®
 DOOR KING®**

120 Glasgow Avenue
 Inglewood, California 90301
 Toll Free: 1-866-400-3600
 Website: www.doorking.com
 Email: ghendrix@doorking.com

COMPONENTS

SL	Slide Gate Operator:
SW	Swing Gate Operator: DoorKing Model 6500
PK	Parking Barrier Operator:
PB	Photo Beam: DoorKing Model 8080-031
RE	Reversing Edge: DoorKing Model 8080-0xx
VL	Vehicle Detecting Loop - DoorKing - Type 9402-xxx
OD1	Opening Device 1: DoorKing DKProx Card Reader
OD2	Opening Device 2:
OD3	Opening Device 3:
MP	Mounting Post: DoorKing Model 1200-xxx
SP	Slide Gate Panel
SWP	Swing Gate Panel
GT	Gate Travel
TS	Tail Section

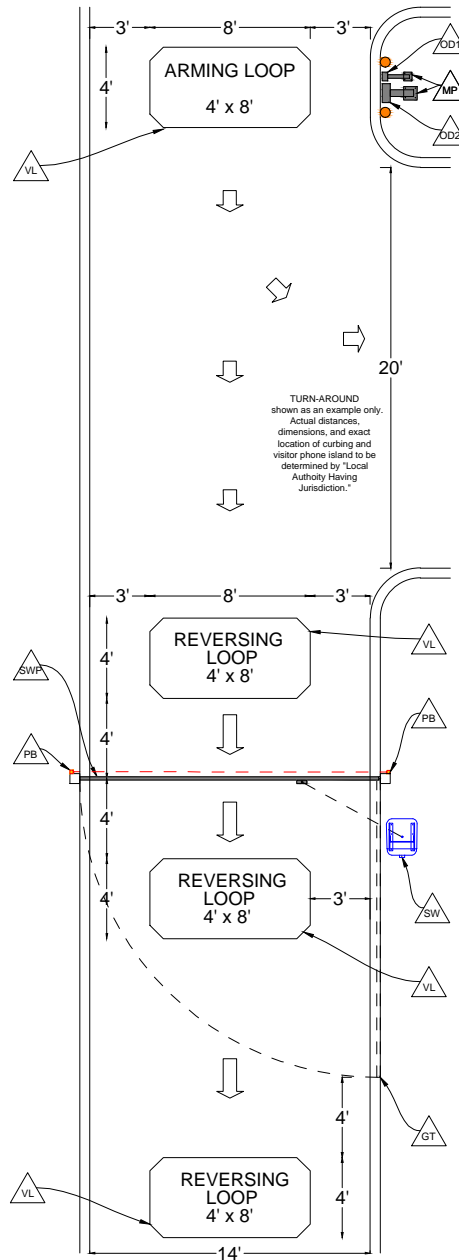

LAYOUT_DESCRIPTION:

Gate Style = Single-leaf Swinging
 DoorKing Model 6500
 w/ One-Way Drive & Turn-around
 w/ Telephone Entry System
 w/ DoorKing Card Reader/Keypad
 w/
 Right-hand Operator Mount
 w/ 4' Loops for Normal Vehicles

Layout 11

GENERAL NOTES

- Automated vehicular gates shall be designed and installed to be in strict compliance with the UL 325 Safety Standard and the ASTM F2200 Construction Standard.
- Automated vehicular gates that do not meet the requirements of these standards shall not be allowed.
- This drawing is for the sole purpose of general gate operator foot-print and location, photo beam coverage and placement, and vehicular loop dimensions and placement. Drawings are not all inclusive or guaranteed to scale.
- No considerations have been made for grade, existing public utilities, landscape, drainage, site peculiarities, or requirements by the authority having jurisdiction, i.e; Fire Marshall, Building Inspector, Street and Alley Departments.
- Warning Signs must be installed and must be highly visible upon both entry and exit of the property, and must remain in place for the life of the gate operating system.
- Proper lane identification and vehicular direction signs should be highly visible upon entry onto the property.
- Gate dimensions, posts, guide rollers, photo beams, reversing edges, hinges, and other gate hardware may vary in size, dimension, and placement and should not be used as an exact reference.
- All loop sizing and placement dimensions indicated are solely intended for reference only, and not intended to be the final criterion for determining the loop sizing and placement on any automated vehicular gate project. DoorKing, Inc does not assume responsibility or liability for any installation with regard to equipment/system malfunction, vehicle detector loop sizing and placement, or consequent damages or injuries caused thereby.
- DoorKing, Inc. does not assume responsibility or liability for the installation and unauthorized changes to the design and operation of equipment, or alterations to the final site plan.

LAYOUT_DESCRIPTION

LAYOUT 11

NTS
 NOT TO SCALE

DKS®
DOOR KING®

120 Glasgow Avenue
 Inglewood, California 90301
 Toll Free: 1-866-400-3600
 Website: www.doorking.com
 Email: ghendrix@doorking.com

COMPONENTS

SL	Slide Gate Operator:
SW	Swing Gate Operator: DoorKing Model 6500
PK	Parking Barrier Operator:
PB	Photo Beam: DoorKing Model 8080-031
RE	Reversing Edge: DoorKing Model 8080-0xx
VL	Vehicle Detecting Loop - DoorKing - Type 9402-xxx
OD1	Opening Device 1: DoorKing DKProx Card Reader
OD2	Opening Device 2:
OD3	Opening Device 3:
MP	Mounting Post: DoorKing Model 1200-xxx
SP	Slide Gate Panel
SWP	Swing Gate Panel
GT	Gate Travel
TS	Tail Section

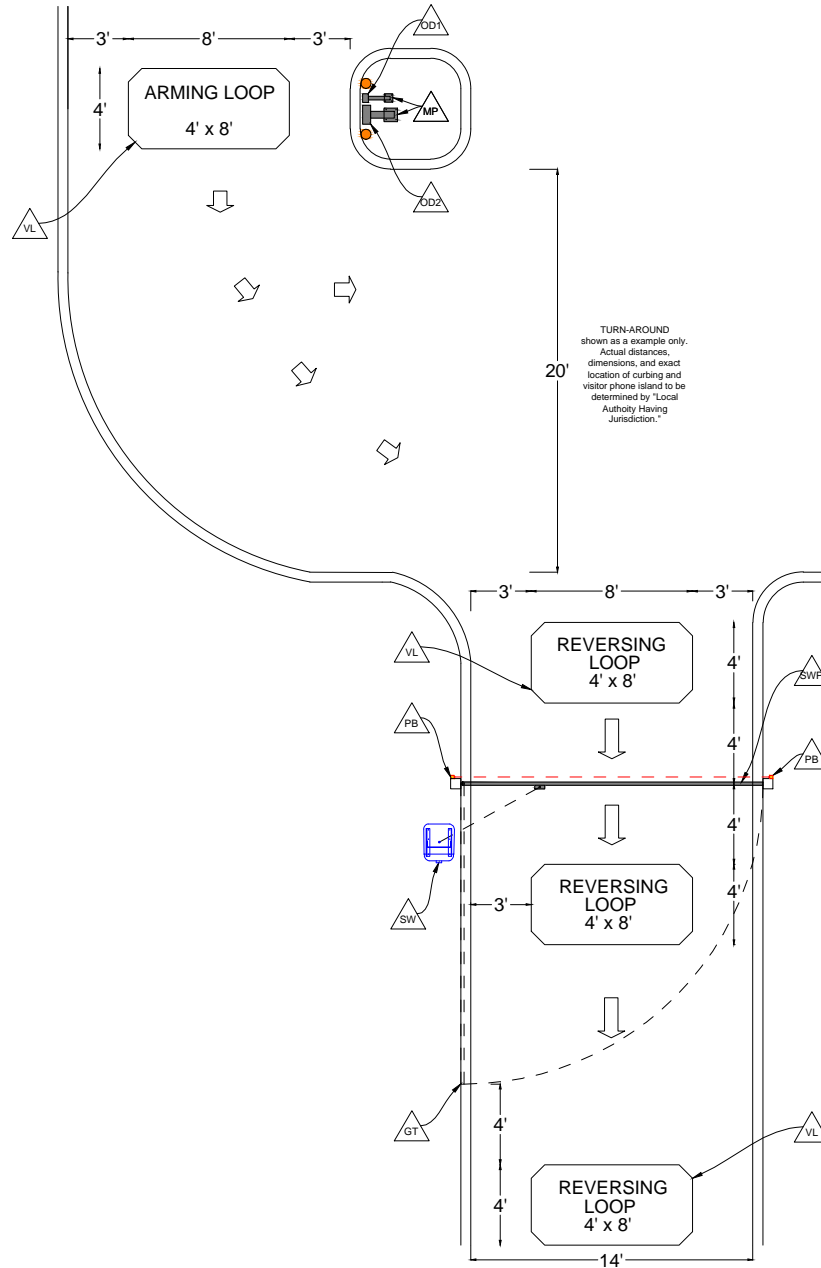

LAYOUT_DESCRIPTION:

Gate Style = Single-leaf Swinging
 DoorKing Model 6500
 w/ One-Way Drive & Off-set Turn-around
 w/ Telephone Entry System
 w/ DoorKing Card Reader/Keypad
 w/ Left-hand Operator Mount
 w/ 4' Loops for Normal Vehicles

Layout 12

GENERAL NOTES

- Automated vehicular gates shall be designed and installed to be in strict compliance with the UL 325 Safety Standard and the ASTM F2200 Construction Standard.
- Automated vehicular gates that do not meet the requirements of these standards shall not be allowed.
- This drawing is for the sole purpose of general gate operator foot-print and location, photo beam coverage and placement, and vehicular loop dimensions and placement. Drawings are not all inclusive or guaranteed to scale.
- No considerations have been made for grade, existing public utilities, landscape, drainage, site peculiarities, or requirements by the authority having jurisdiction, ie; Fire Marshall, Building Inspector, Street and Alley Departments.
- Warning Signs must be installed and must be highly visible upon both entry and exit of the property, and must remain in place for the life of the gate operating system.
- Proper lane identification and vehicular direction signs should be highly visible upon entry onto the property.
- Gate dimensions, posts, guide rollers, photo beams, reversing edges, hinges, and other gate hardware may vary in size, dimension, and placement and should not be used as an exact reference.
- All loop sizing and placement dimensions indicated are solely intended for reference only, and not intended to be the final criterion for determining the loop sizing and placement on any automated vehicular gate project. DoorKing, Inc does not assume responsibility or liability for any installation with regard to equipment/system malfunction, vehicle detector loop sizing and placement, or consequent damages or injuries caused thereby.
- DoorKing, Inc. does not assume responsibility or liability for the installation and unauthorized changes to the design and operation of equipment, or alterations to the final site plan.

LAYOUT_DESCRIPTION

LAYOUT 12

NTS
 NOT TO SCALE

**DKS®
 DOOR KING®**

120 Glasgow Avenue
 Inglewood, California 90301
 Toll Free: 1-866-400-3600
 Website: www.doorking.com
 Email: ghendrix@doorking.com