

Durable Corporation
(800) 537-1603

Model: B4506-24

MODEL: B4506-24

Size

Projection 4-1/2"
Height 6"

Length:

-Overall 26"
-Anchor Holes 24"
-Rubber 20"
Angle Size (2) 1/4"x3"x3"x5-1/2"

Bolt Heads Are Inscribed
"DURABLE CORP"

Date: 04/01/07

All measurements are +/- 1/8"

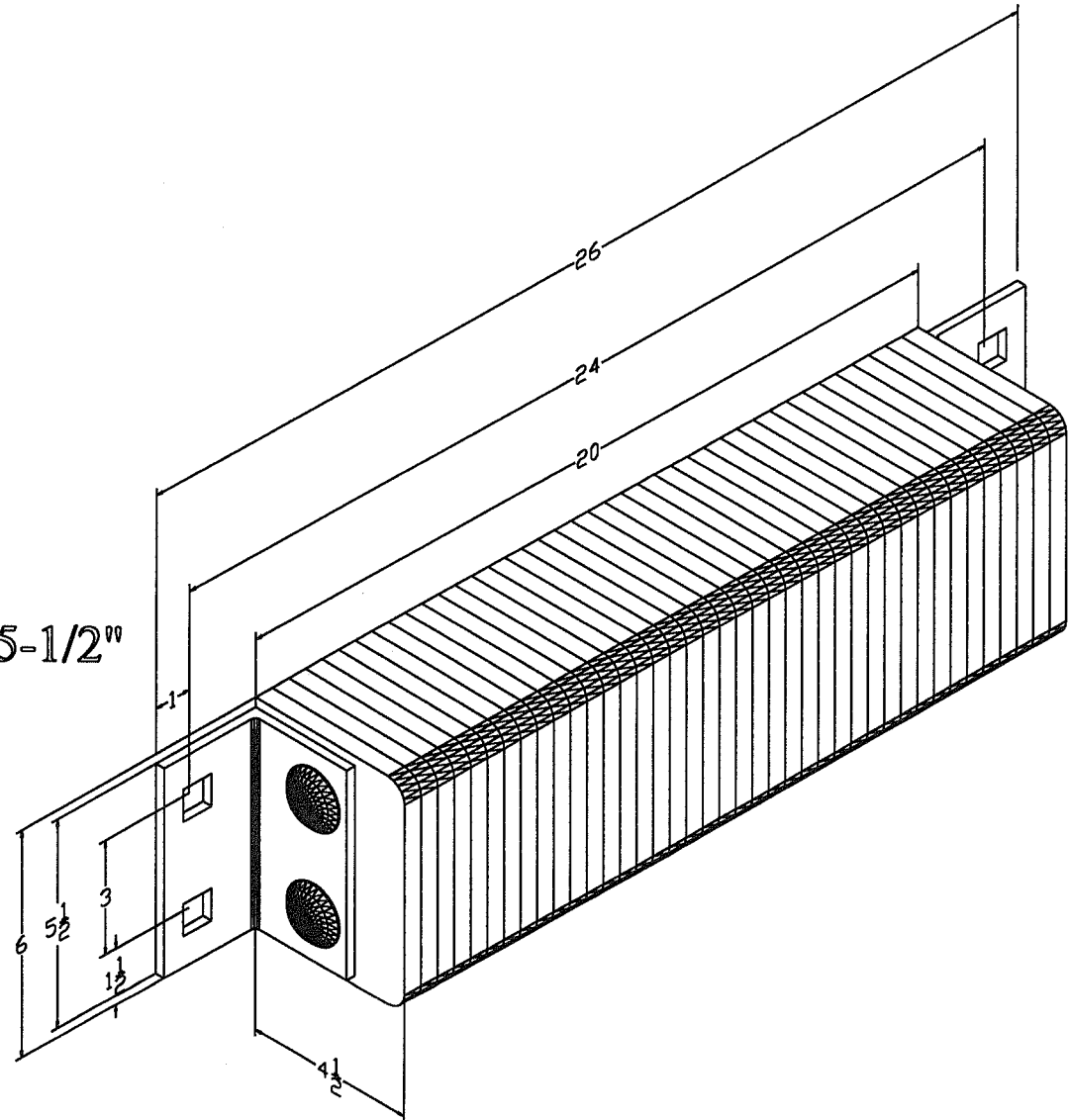

Confidential -- Property of Durable Corporation