

IN-FLOOR INSTALLATION

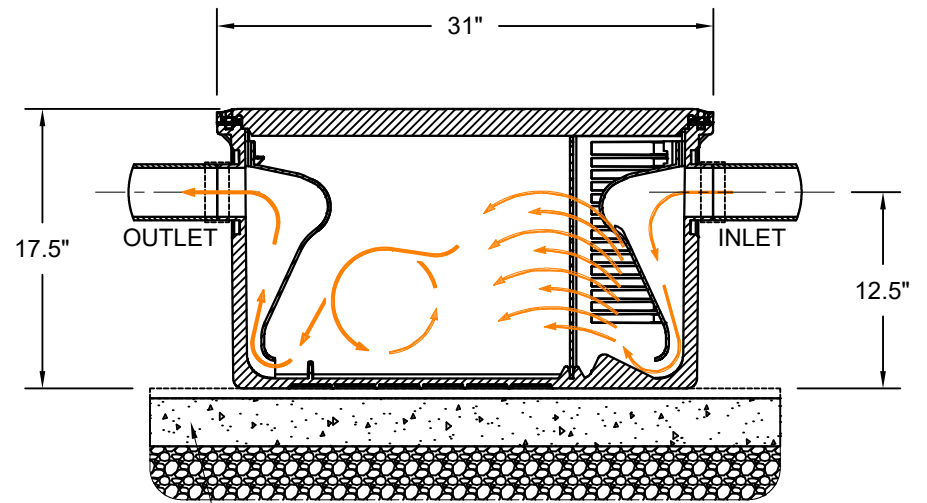

ON-FLOOR INSTALLATION

LEVEL, NON-ABSORBENT MATERIAL FOR EVEN SUPPORT OF TANK

**NOTE:**

1. FINISH TO FLOOR LEVEL ACCOMMODATING REQUISITE MATERIALS, E.G. TILE, MORTAR, ETC.
2. ACCESSIBLE FLOW CONTROL DEVICE (FCD) IS SUPPLIED FOR INSTALLATION UPSTREAM OF THE GREASE INTERCEPTOR (GI) -- 4" INLET/OUTLET
3. MODULAR EXTENSION RISER (3935AX6) AVAILABLE. MAX. 3 FOR INSTALL (OPTIONAL).



ASME A112.14.3



G-101



B481.1



NK CAD DESIGN  
WWW.NKCADD.COM  
289-689-3882

35GPM GREASE INTERCEPTOR  
PART NO. 3935A04



DATE:	DEC-18-15
SCALE:	1"=1'-0"
DWG NO:	3935A04 / 2