

**FABRAL**

Project: \_\_\_\_\_

Contractor: \_\_\_\_\_

THIS DRAWING IS THE PROPERTY OF FABRAL, INC. THE USE OF THIS DRAWING WITHOUT THE EXPRESS PERMISSION OF FABRAL IS PROHIBITED.

**FABRAL, INC.**  
 3449 Hempland Road  
 Lancaster, PA 17601  
 800-477-2741

**FIXED HIP/RIDGE DETAIL (HR-1)**

**POWER SEAM**

Issued:  
 APRIL 2012

NOT USED

**FABRAL**

Project:

Contractor:

THIS DRAWING IS THE  
PROPERTY OF FABRAL,  
INC. THE USE OF THIS  
DRAWING WITHOUT THE  
EXPRESS PERMISSION OF  
FABRAL IS PROHIBITED.

**FABRAL, INC.**  
3449 Hempland Road  
Lancaster, PA 17601  
800-477-2741

**POWER SEAM**

Issued:

APRIL 2012

NOT USED

**FABRAL**

Project:

Contractor:

THIS DRAWING IS THE  
PROPERTY OF FABRAL,  
INC. THE USE OF THIS  
DRAWING WITHOUT THE  
EXPRESS PERMISSION OF  
FABRAL IS PROHIBITED.

**FABRAL, INC.**  
3449 Hempland Road  
Lancaster, PA 17601  
800-477-2741

**POWER SEAM**

Issued  
APRIL 2012

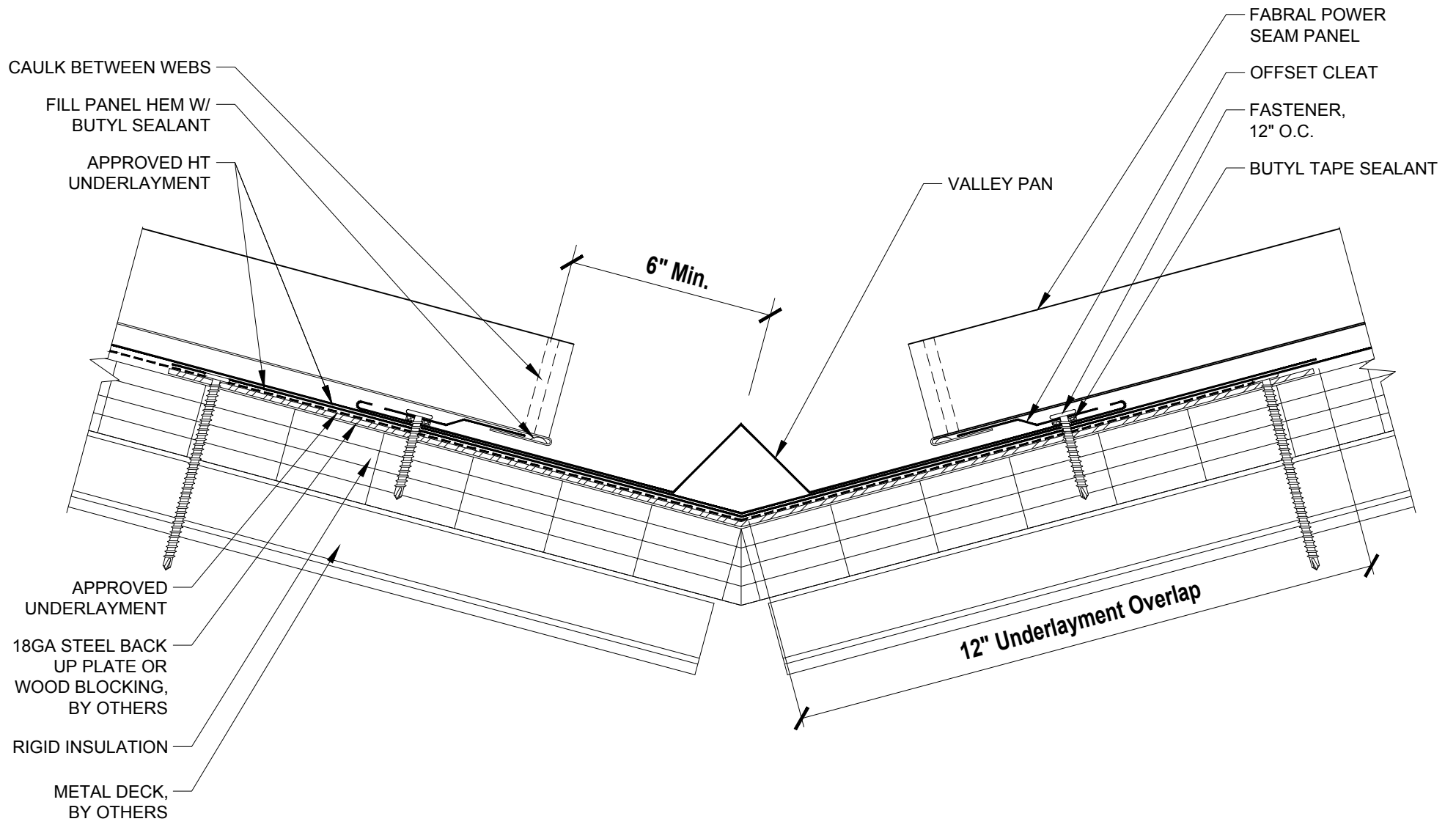

**FABRAL**

Project:

Contractor:

THIS DRAWING IS THE PROPERTY OF FABRAL, INC. THE USE OF THIS DRAWING WITHOUT THE EXPRESS PERMISSION OF FABRAL IS PROHIBITED.

**FABRAL, INC.**  
 3449 Hempland Road  
 Lancaster, PA 17601  
 800-477-2741

**VALLEY DETAIL (V-1)**

**POWER SEAM**

Issued:  
 APRIL 2012

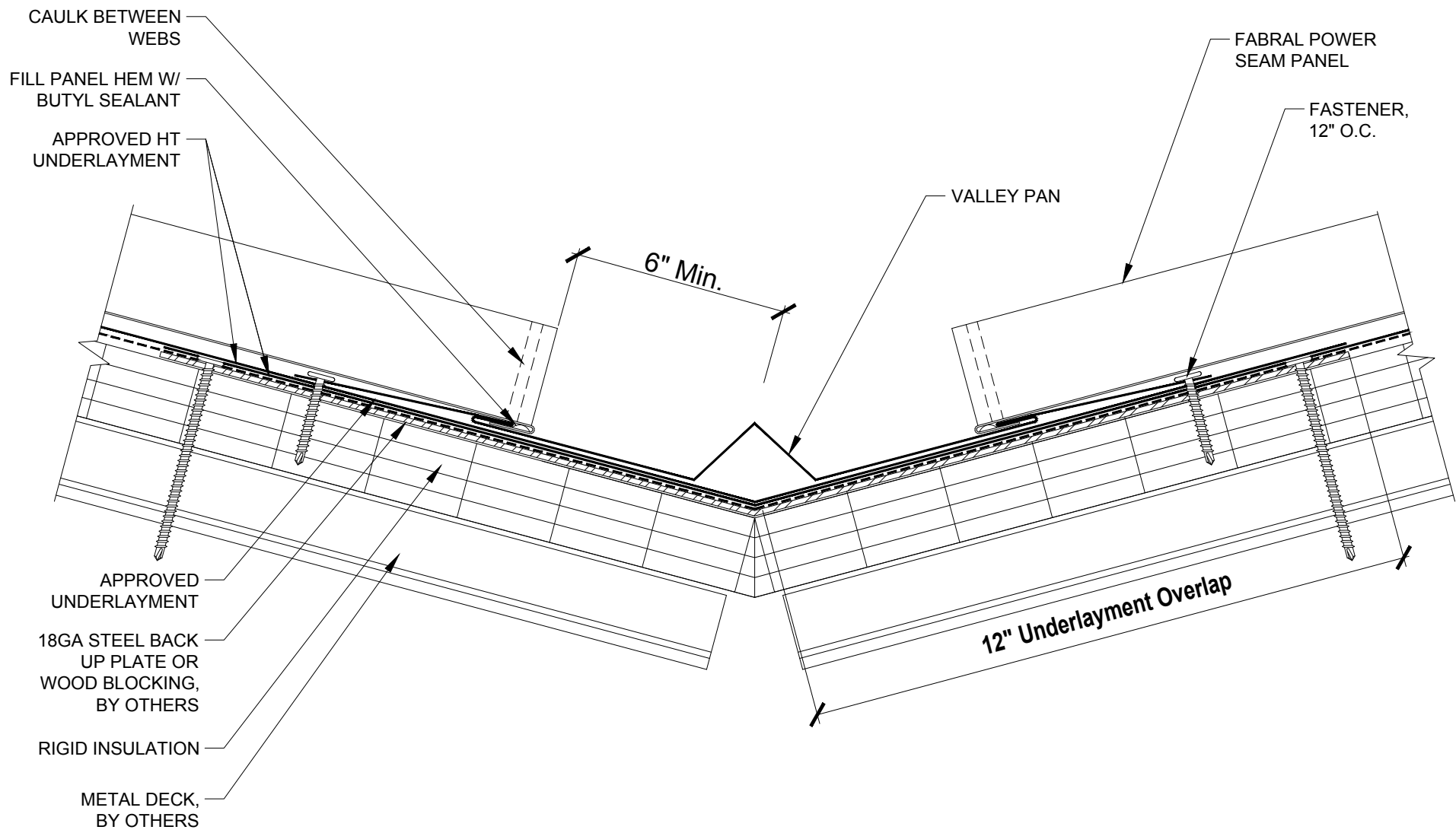

**FABRAL**

Project:

Contractor:

THIS DRAWING IS THE PROPERTY OF FABRAL, INC. THE USE OF THIS DRAWING WITHOUT THE EXPRESS PERMISSION OF FABRAL IS PROHIBITED.

**FABRAL, INC.**  
 3449 Hempland Road  
 Lancaster, PA 17601  
 800-477-2741

**VALLEY DETAIL (V-2)**

**POWER SEAM**

Issued:  
 APRIL 2012

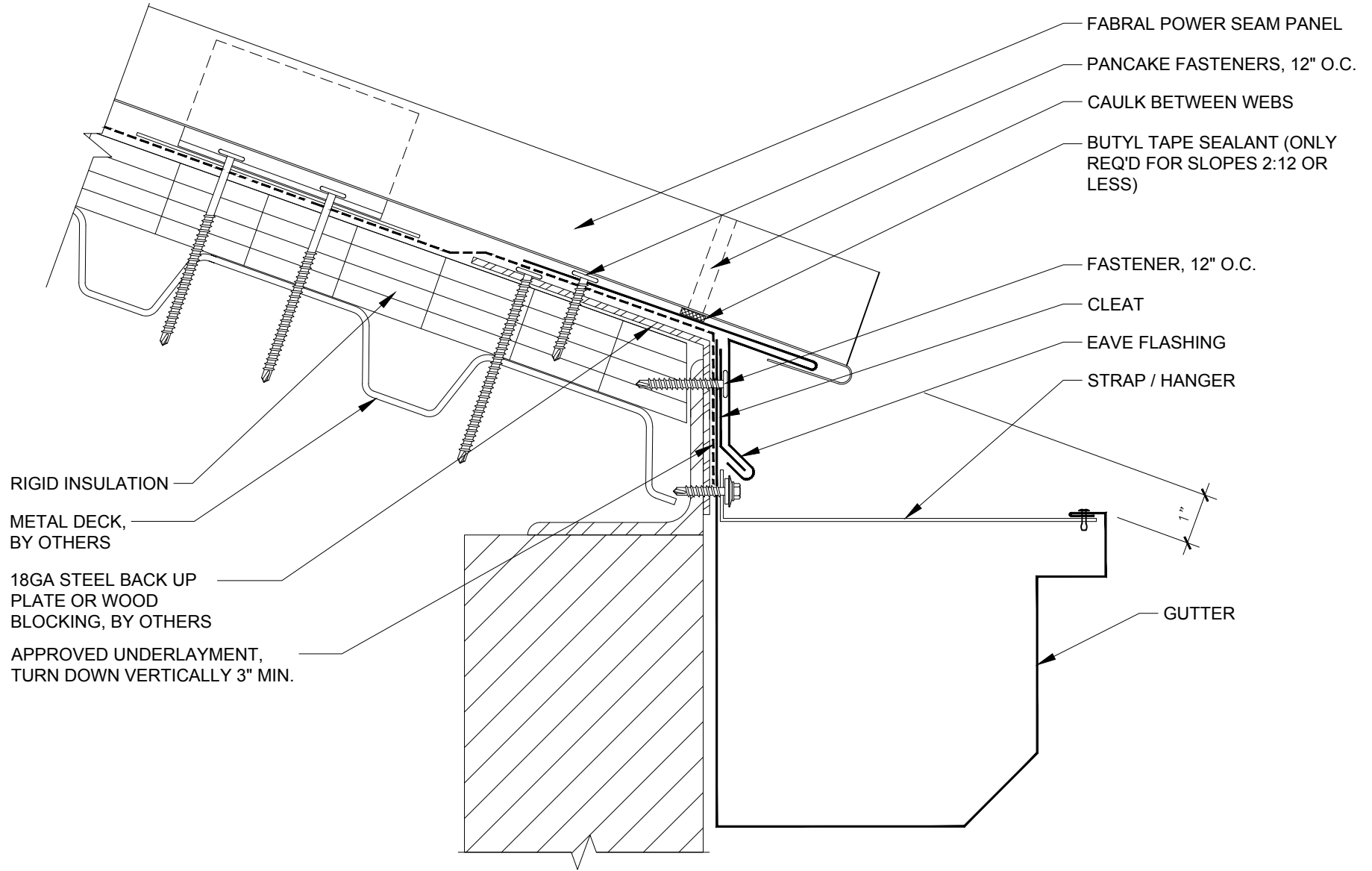

**FABRAL**

Project:

Contractor:

**SLIDING EAVE W/ GUTTER DETAIL (EG-1)**

THIS DRAWING IS THE PROPERTY OF FABRAL, INC. THE USE OF THIS DRAWING WITHOUT THE EXPRESS PERMISSION OF FABRAL IS PROHIBITED.

**FABRAL, INC.**  
 3449 Hempland Road  
 Lancaster, PA 17601  
 800-477-2741

**POWER SEAM**

Issued:  
 APRIL 2012

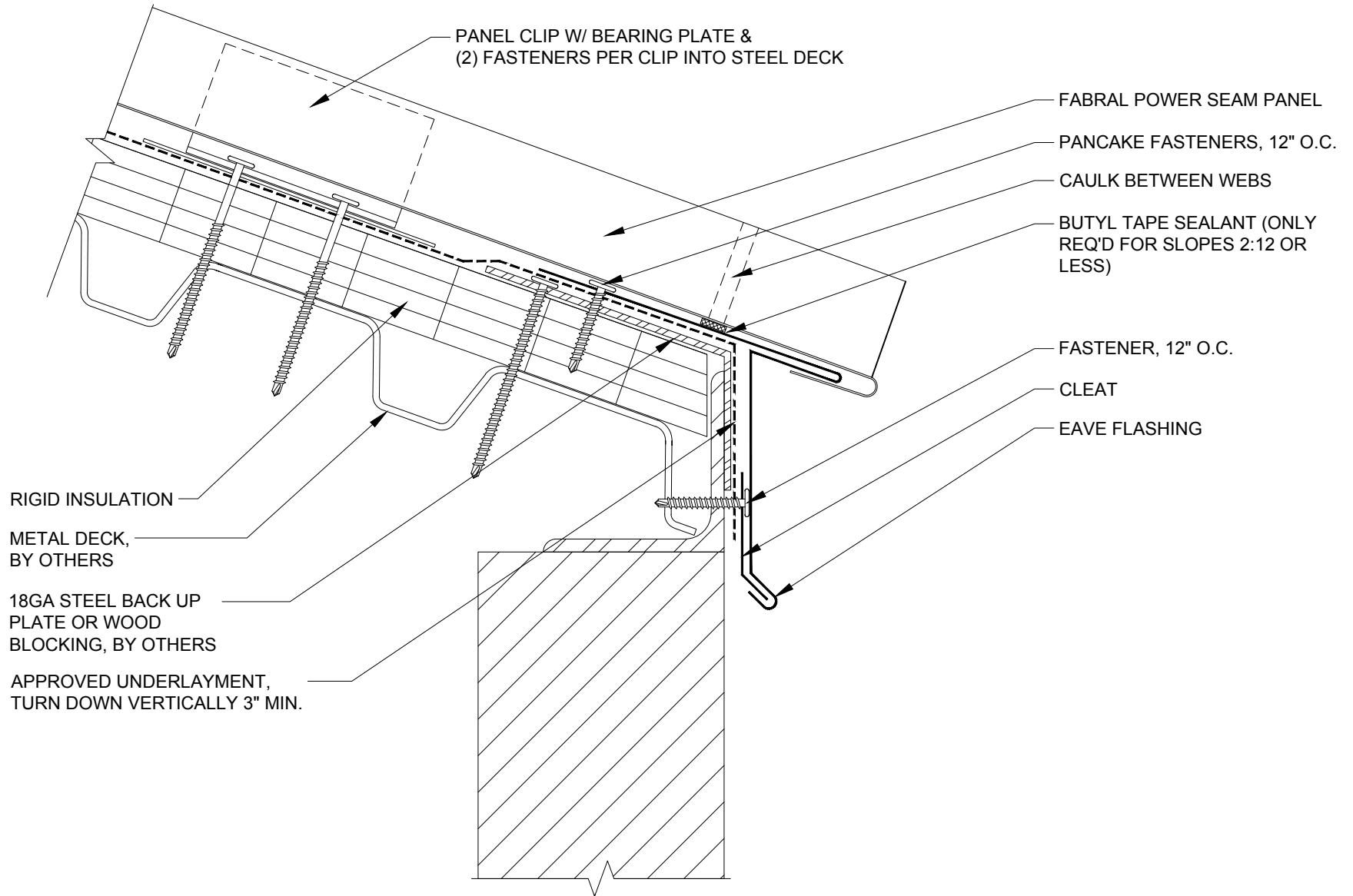

**FABRAL**

Project:

Contractor:

THIS DRAWING IS THE PROPERTY OF FABRAL, INC. THE USE OF THIS DRAWING WITHOUT THE EXPRESS PERMISSION OF FABRAL IS PROHIBITED.

**FABRAL, INC.**  
 3449 Hempland Road  
 Lancaster, PA 17601  
 800-477-2741

**SLIDING EAVE DETAIL (E-1)**

**POWER SEAM**

Issued:  
 APRIL 2012

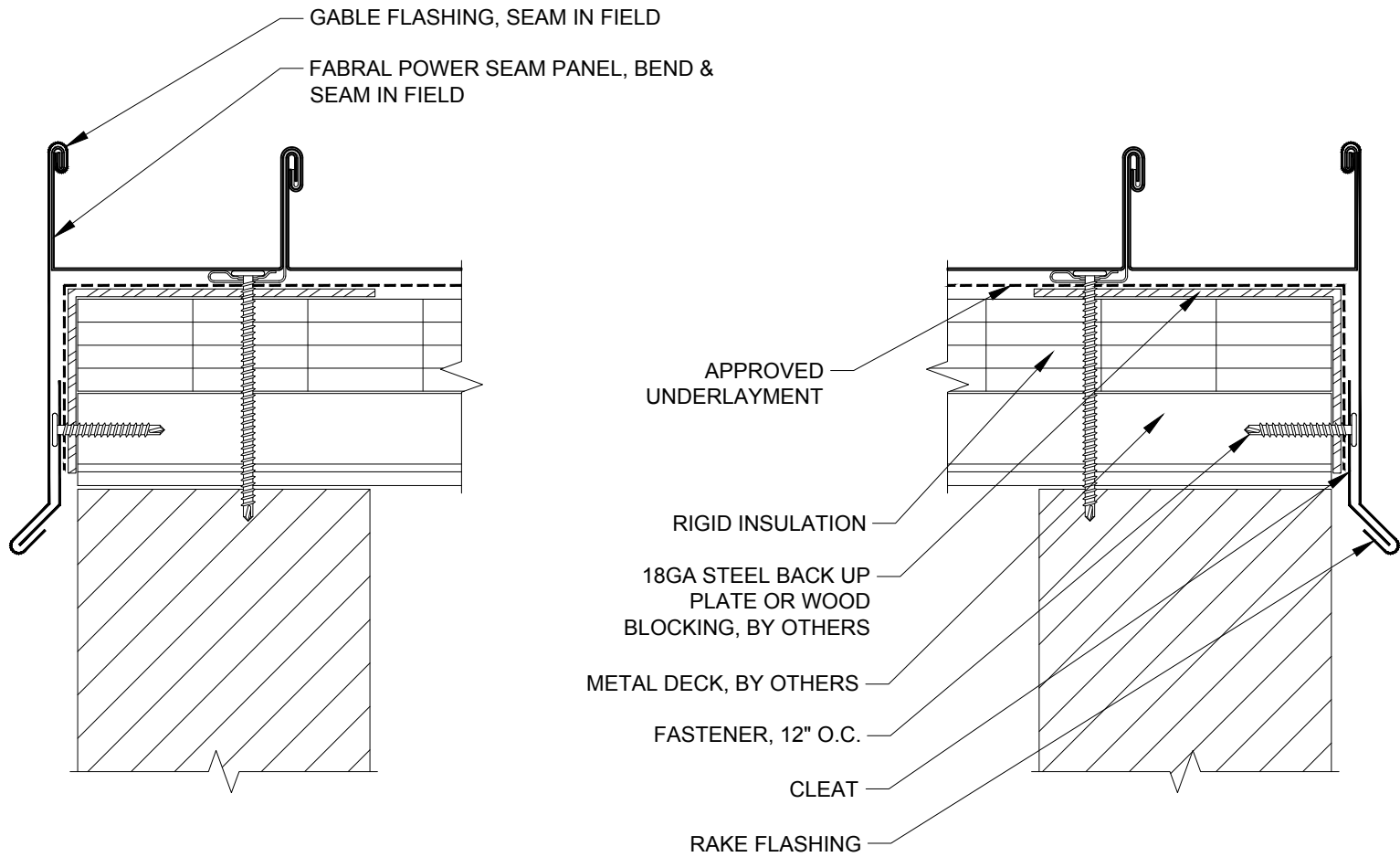

**FABRAL**

Project:

Contractor:

THIS DRAWING IS THE PROPERTY OF FABRAL, INC. THE USE OF THIS DRAWING WITHOUT THE EXPRESS PERMISSION OF FABRAL IS PROHIBITED.

**FABRAL, INC.**  
 3449 Hempland Road  
 Lancaster, PA 17601  
 800-477-2741

**SLIDING GABLE DETAIL (G-1)**

**POWER SEAM**

Issued:  
 APRIL 2012



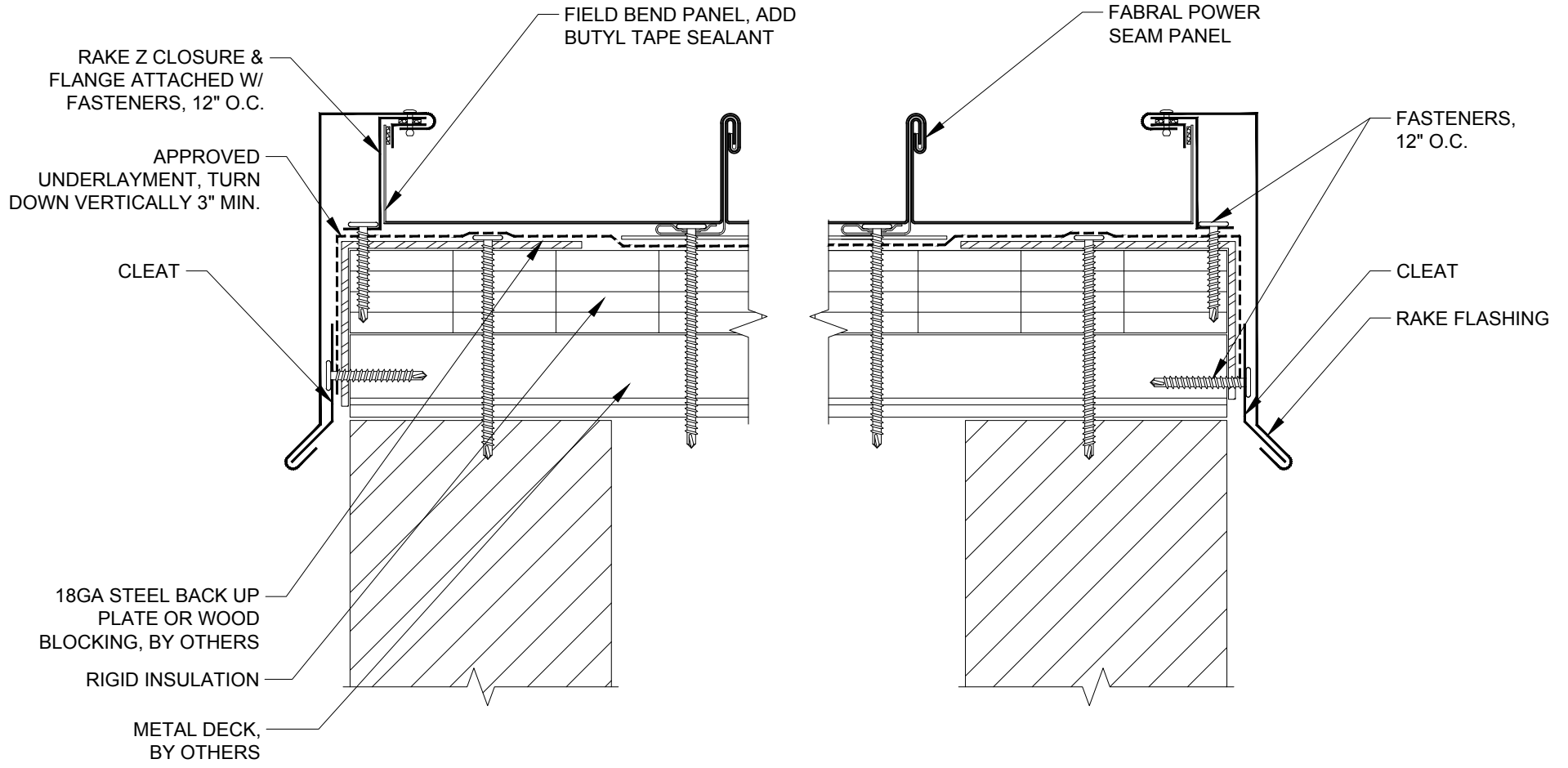

**FABRAL**

Project:

Contractor:

THIS DRAWING IS THE PROPERTY OF FABRAL, INC. THE USE OF THIS DRAWING WITHOUT THE EXPRESS PERMISSION OF FABRAL IS PROHIBITED.

**FABRAL, INC.**  
 3449 Hempland Road  
 Lancaster, PA 17601  
 800-477-2741

**SLIDING GABLE DETAIL (G-2)**

**POWER SEAM**

Issued:  
 APRIL 2012

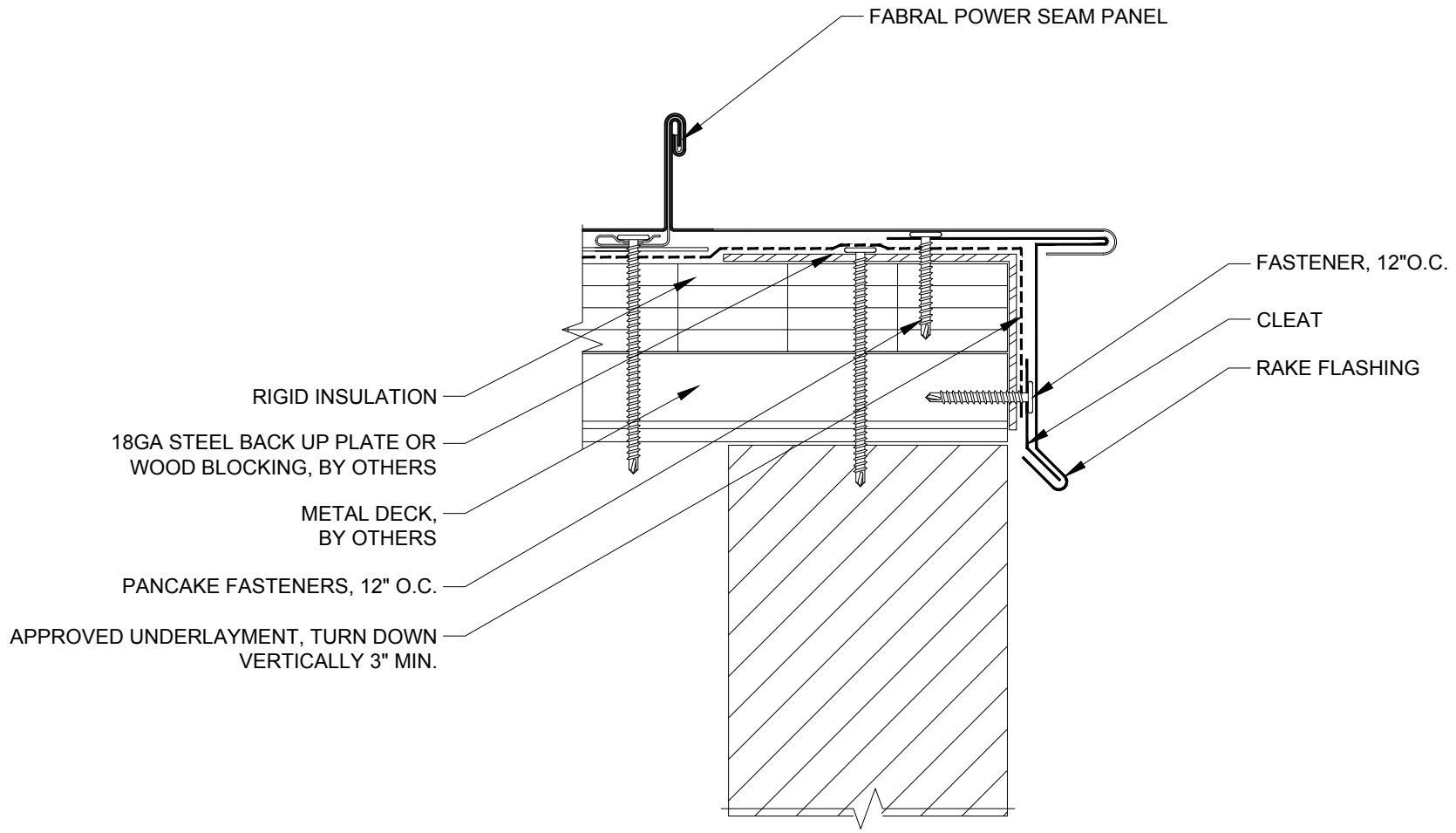

**FABRAL**

Project:

Contractor:

THIS DRAWING IS THE PROPERTY OF FABRAL, INC. THE USE OF THIS DRAWING WITHOUT THE EXPRESS PERMISSION OF FABRAL IS PROHIBITED.

**FABRAL, INC.**  
 3449 Hempland Road  
 Lancaster, PA 17601  
 800-477-2741

**SLIDING GABLE DETAIL (G-3)**

**POWER SEAM**

Issued:  
 APRIL 2012

FABRAL POWER SEAM PANEL, BOX  
PANEL END

FASTENER, 12" O.C.

BUTYL TAPE SEALANT

Z CLOSURE CUT TO FIT, SET IN  
BUTYL TAPE SEALANT, (5)  
FASTENERS PER PANEL. FILL  
ALL VOIDS WITH APPROVED  
SEALANT

PANEL CLIP W/ BEARING  
PLATE & (2) FASTENERS  
PER CLIP INTO STEEL DECK

RIGID INSULATION

METAL DECK BY OTHERS

18GA STEEL BACK UP PLATE OR  
WOOD BLOCKING, BY OTHERS

PEAK FLASHING

APPROVED SEALANT

FABRAL POWER SEAM PANEL, BOX  
PANEL END

APPROVED UNDERLAYMENT, TURN  
DOWN VERTICALLY 3" MIN.

SD FASTENERS, (5)  
PER PANEL

APPROVED SEALANT

Z CLOSURE SET IN BUTYL TAPE  
SEALANT ATTACHED W/ (5)  
FASTENERS PER PANEL

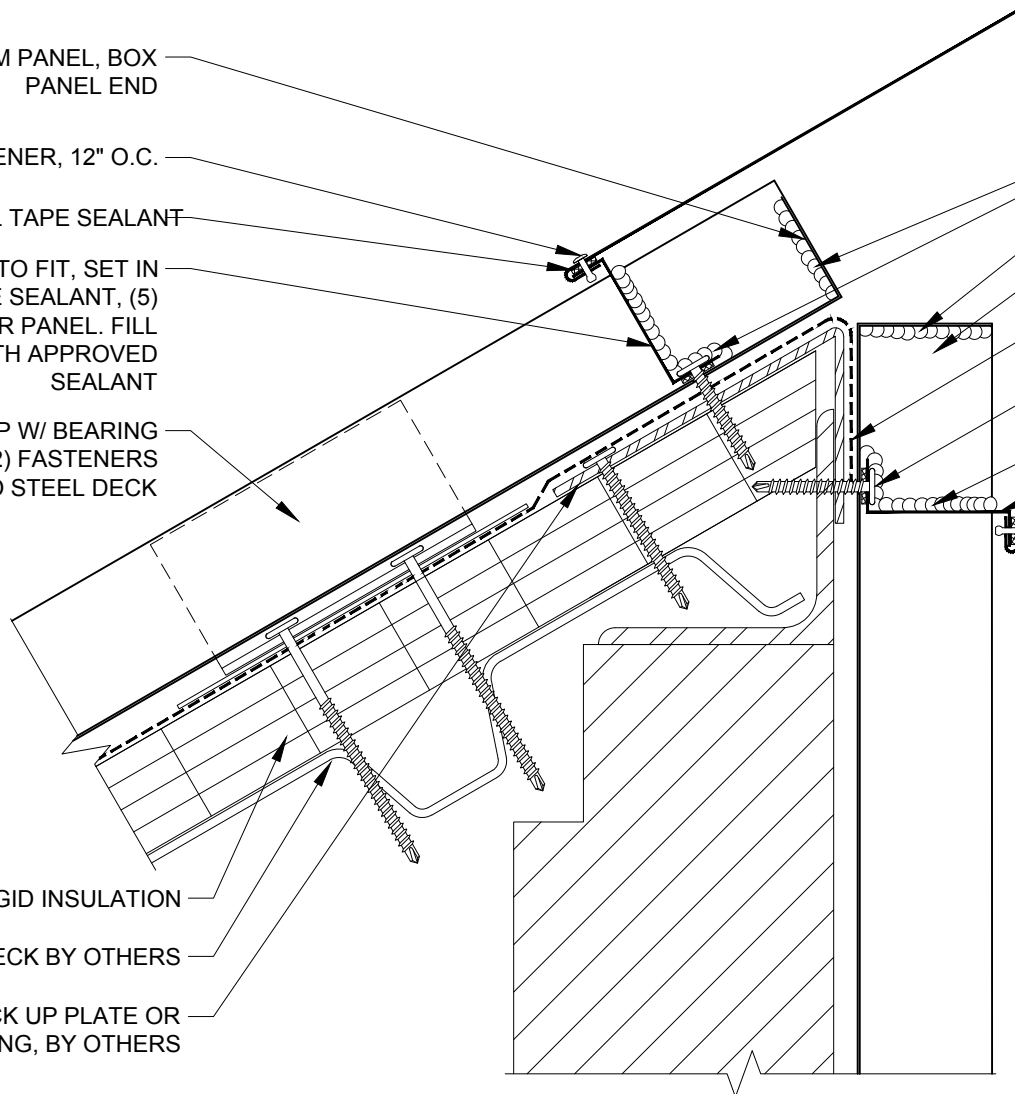

**FABRAL**

Project:

Contractor:

THIS DRAWING IS THE  
PROPERTY OF FABRAL,  
INC. THE USE OF THIS  
DRAWING WITHOUT THE  
EXPRESS PERMISSION OF  
FABRAL IS PROHIBITED.

**FABRAL, INC.**  
3449 Hempland Road  
Lancaster, PA 17601  
800-477-2741

**HIGH SIDE EAVE DETAIL (HSE-1)**

**POWER SEAM**

Issued:

APRIL 2012

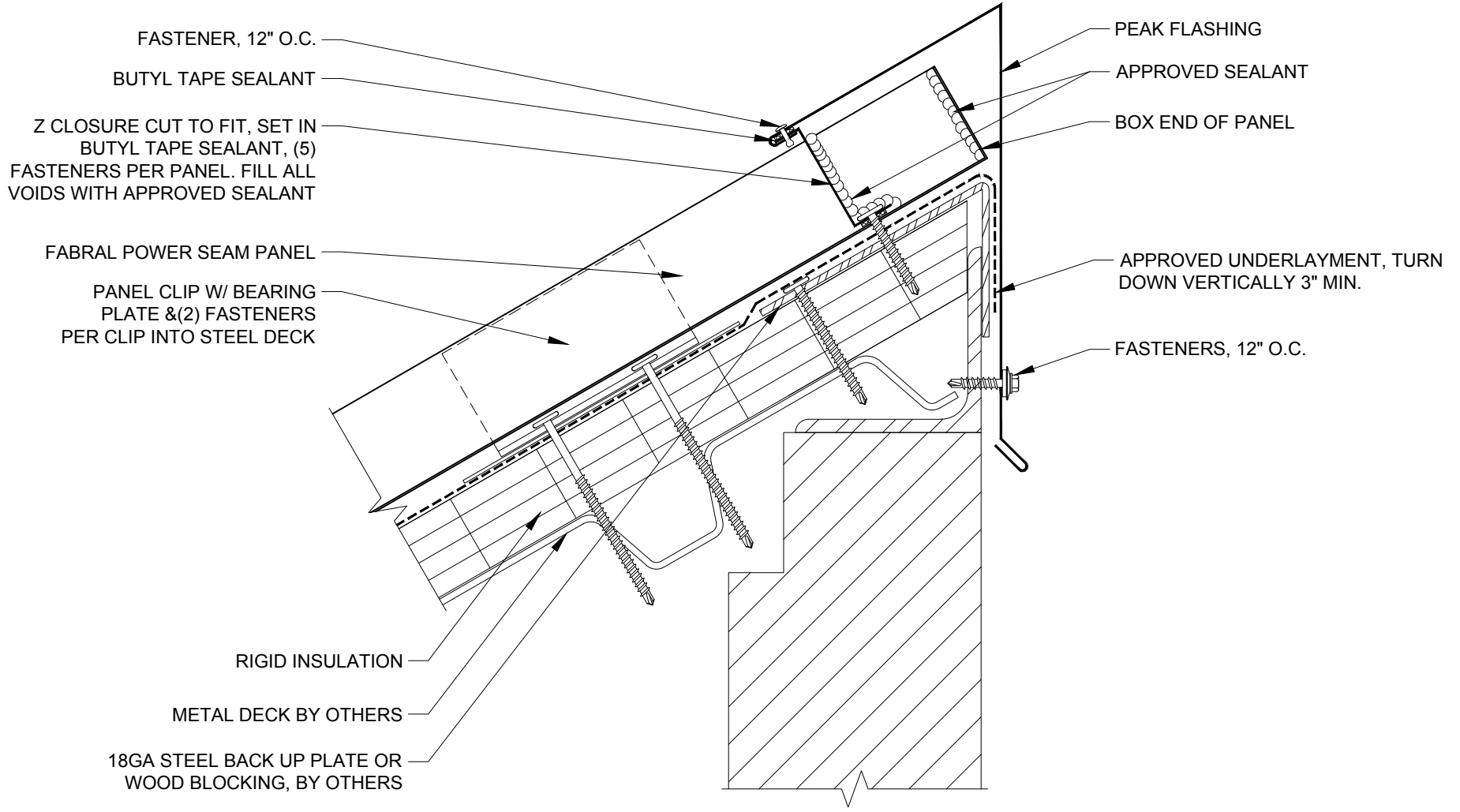

**FABRAL**

Project:

Contractor:

THIS DRAWING IS THE PROPERTY OF FABRAL, INC. THE USE OF THIS DRAWING WITHOUT THE EXPRESS PERMISSION OF FABRAL IS PROHIBITED.

**FABRAL, INC.**  
 3449 Hempland Road  
 Lancaster, PA 17601  
 800-477-2741

**HIGH SIDE EAVE DETAIL (HSE-2)**

**POWER SEAM**

Issued:  
 APRIL 2012

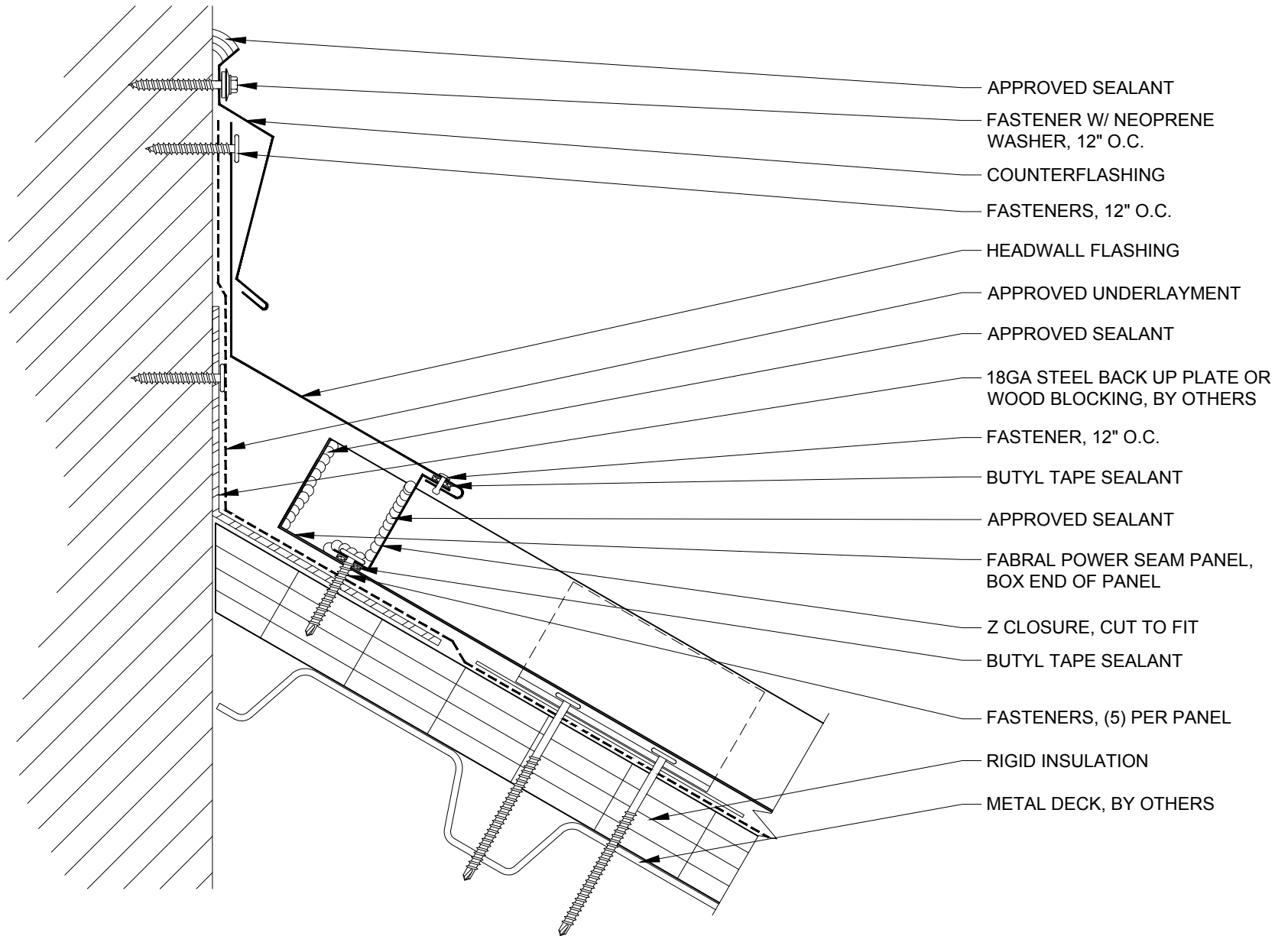

**FABRAL**

Project:

Contractor:

THIS DRAWING IS THE PROPERTY OF FABRAL, INC. THE USE OF THIS DRAWING WITHOUT THE EXPRESS PERMISSION OF FABRAL IS PROHIBITED.

**FABRAL, INC.**  
 3449 Hempland Road  
 Lancaster, PA 17601  
 800-477-2741

**HEADWALL DETAIL (HW-1)**

**POWER SEAM**

Issued:  
 APRIL 2012

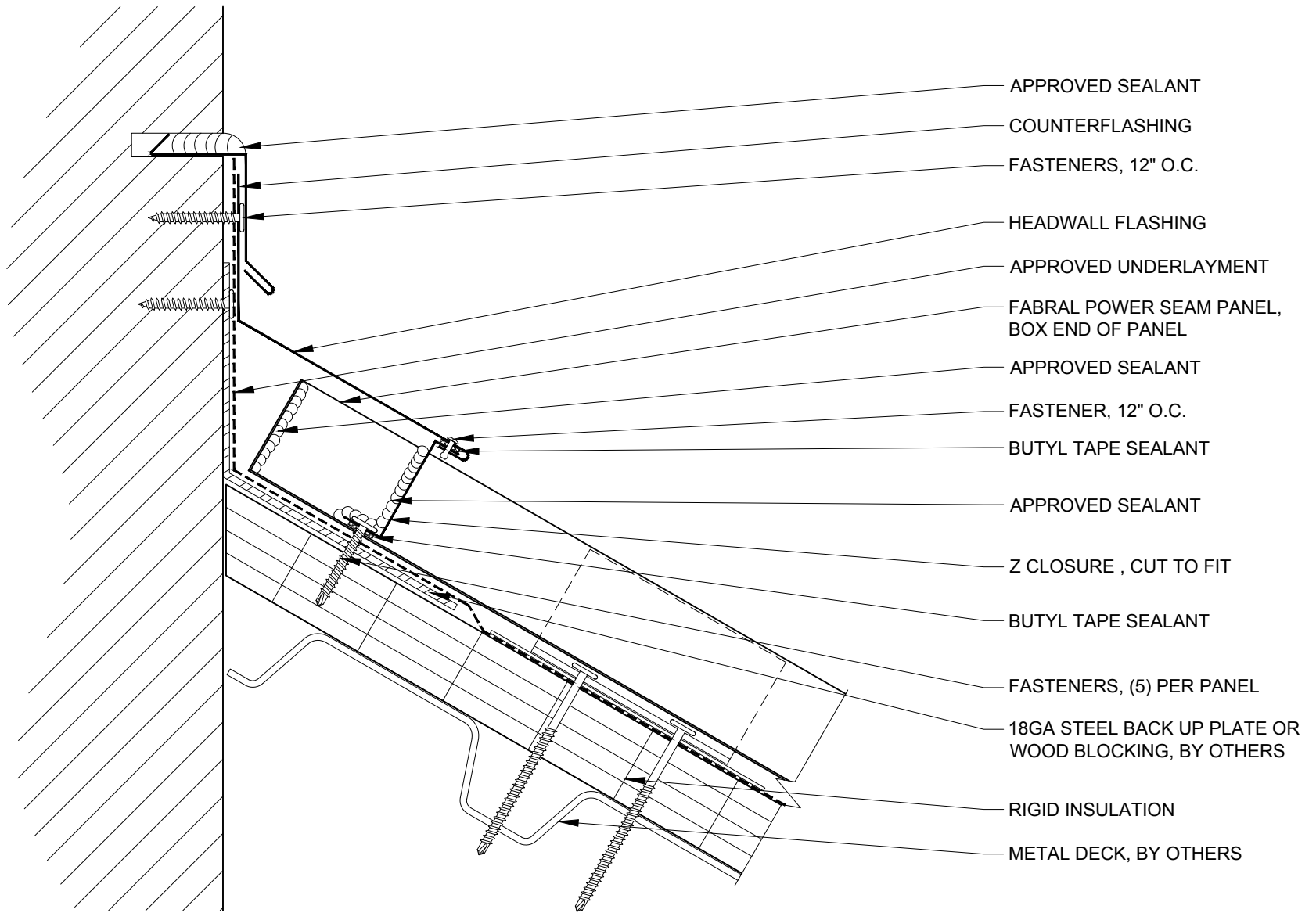

- APPROVED SEALANT
- COUNTERFLASHING
- FASTENERS, 12" O.C.
- HEADWALL FLASHING
- APPROVED UNDERLAYMENT
- FABRAL POWER SEAM PANEL, BOX END OF PANEL
- APPROVED SEALANT
- FASTENER, 12" O.C.
- BUTYL TAPE SEALANT
- APPROVED SEALANT
- Z CLOSURE , CUT TO FIT
- BUTYL TAPE SEALANT
- FASTENERS, (5) PER PANEL
- 18GA STEEL BACK UP PLATE OR WOOD BLOCKING, BY OTHERS
- RIGID INSULATION
- METAL DECK, BY OTHERS

**FABRAL**

Project:

Contractor:

THIS DRAWING IS THE PROPERTY OF FABRAL, INC. THE USE OF THIS DRAWING WITHOUT THE EXPRESS PERMISSION OF FABRAL IS PROHIBITED.

**FABRAL, INC.**  
 3449 Hempland Road  
 Lancaster, PA 17601  
 800-477-2741

**HEADWALL DETAIL (HW-2)**

**POWER SEAM**

Issued:  
 APRIL 2012

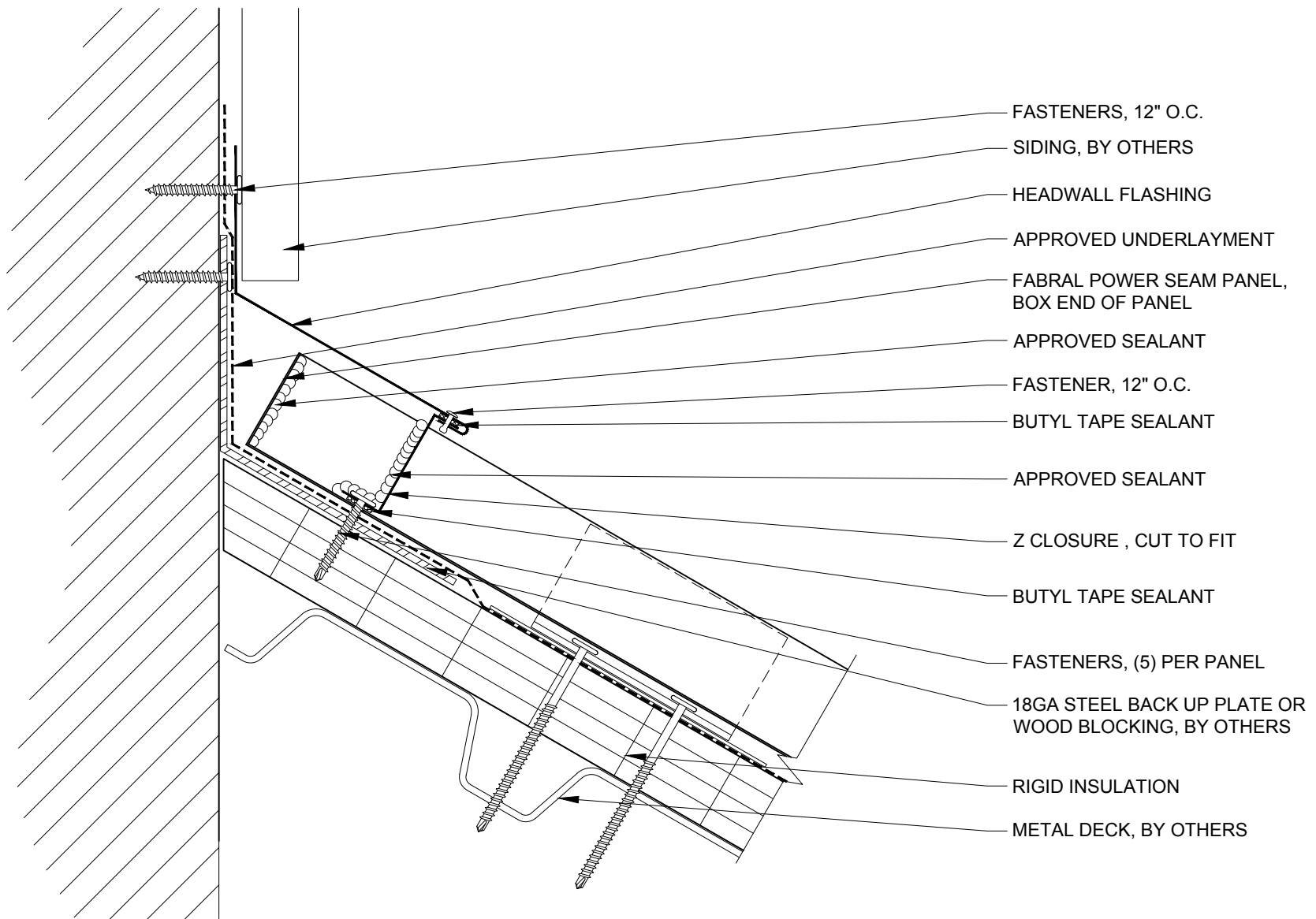

FASTENERS, 12" O.C.

SIDING, BY OTHERS

HEADWALL FLASHING

APPROVED UNDERLAYMENT

FABRAL POWER SEAM PANEL,  
BOX END OF PANEL

APPROVED SEALANT

FASTENER, 12" O.C.

BUTYL TAPE SEALANT

APPROVED SEALANT

Z CLOSURE , CUT TO FIT

BUTYL TAPE SEALANT

FASTENERS, (5) PER PANEL

18GA STEEL BACK UP PLATE OR  
WOOD BLOCKING, BY OTHERS

RIGID INSULATION

METAL DECK, BY OTHERS

**FABRAL**

Project:

Contractor:

THIS DRAWING IS THE  
PROPERTY OF FABRAL,  
INC. THE USE OF THIS  
DRAWING WITHOUT THE  
EXPRESS PERMISSION OF  
FABRAL IS PROHIBITED.

**FABRAL, INC.**  
3449 Hempland Road  
Lancaster, PA 17601  
800-477-2741

**HEADWALL DETAIL (HW-3)**

**POWER SEAM**

Issued:

APRIL 2012

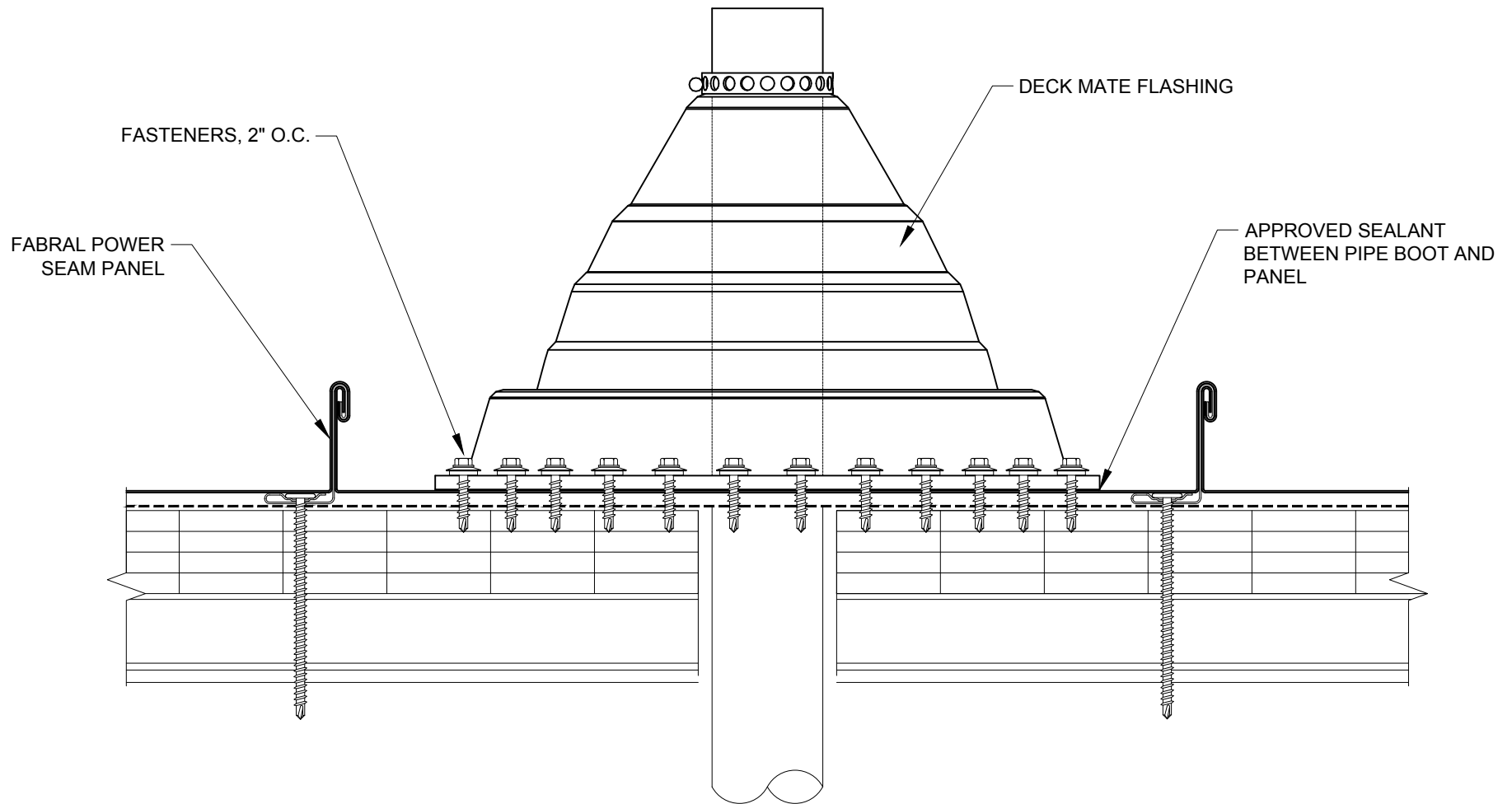

**FABRAL**

Project:

Contractor:

THIS DRAWING IS THE PROPERTY OF FABRAL, INC. THE USE OF THIS DRAWING WITHOUT THE EXPRESS PERMISSION OF FABRAL IS PROHIBITED.

**FABRAL, INC.**  
 3449 Hempland Road  
 Lancaster, PA 17601  
 800-477-2741

**PENETRATION DETAIL (P-1)**

**POWER SEAM**

Issued:  
 APRIL 2012



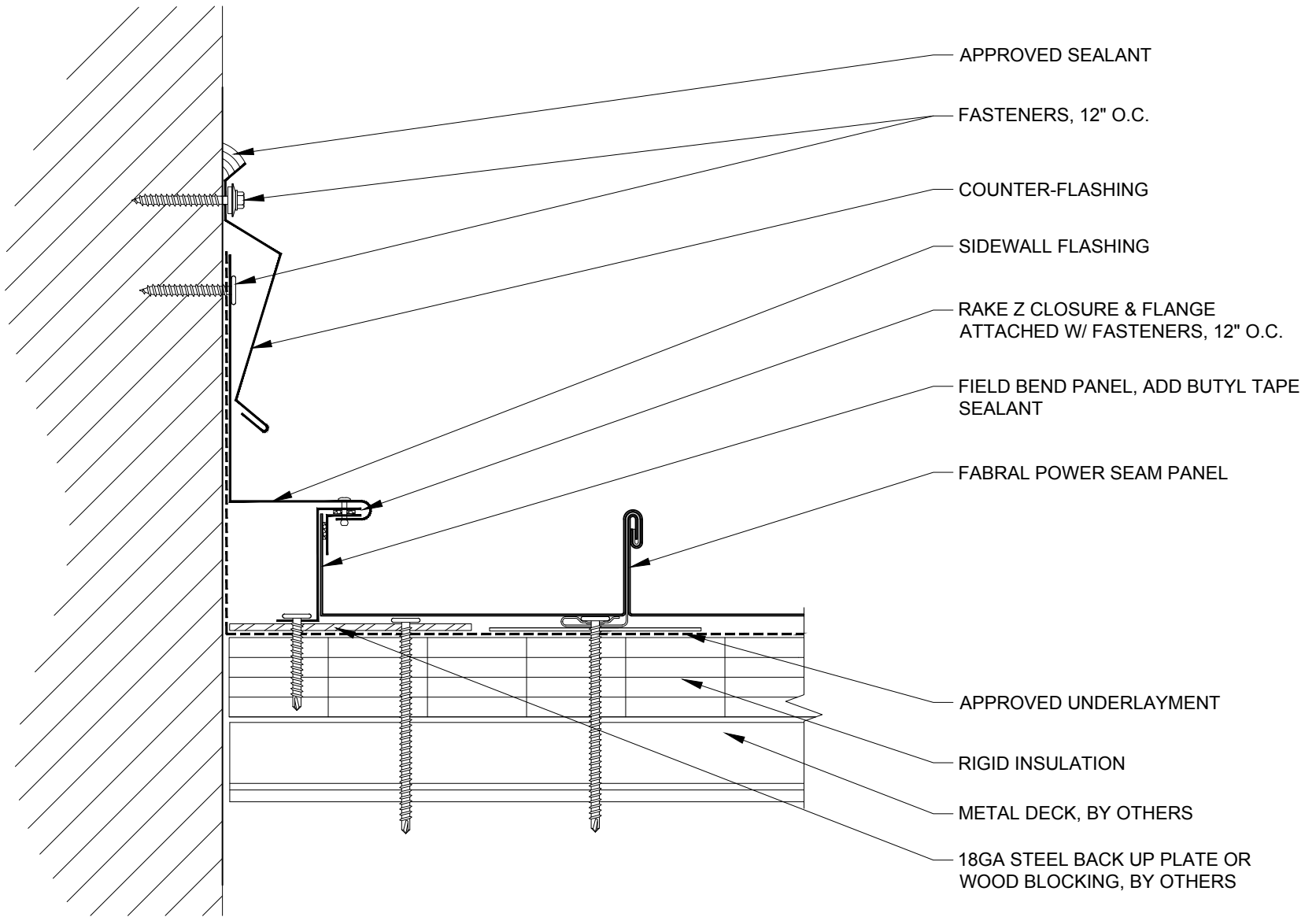

**FABRAL**

Project:

Contractor:

THIS DRAWING IS THE PROPERTY OF FABRAL, INC. THE USE OF THIS DRAWING WITHOUT THE EXPRESS PERMISSION OF FABRAL IS PROHIBITED.

**FABRAL, INC.**  
 3449 Hempland Road  
 Lancaster, PA 17601  
 800-477-2741

**SIDEWALL DETAIL (SW-1)**

**POWER SEAM**

Issued:  
 APRIL 2012

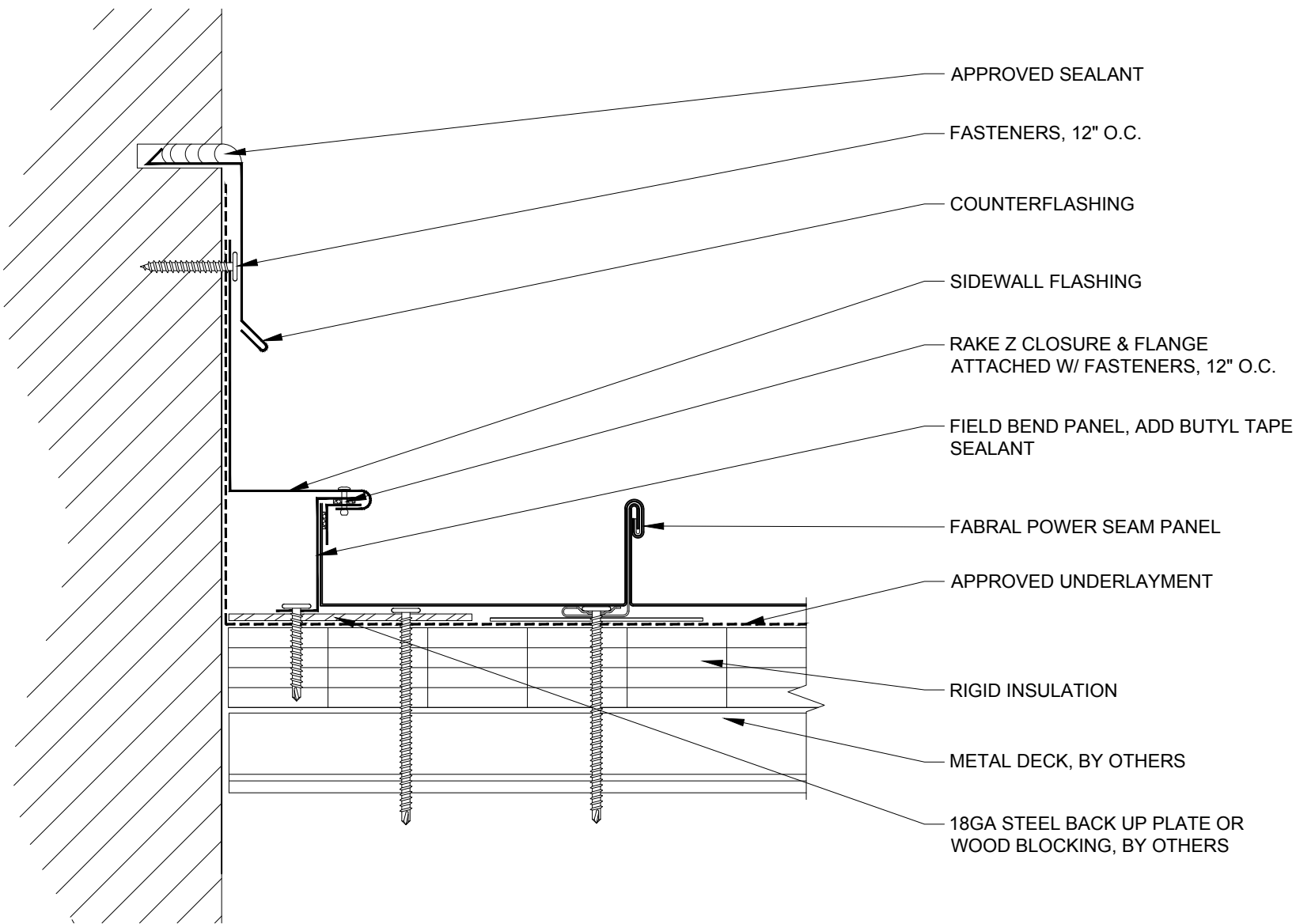

**FABRAL**

Project:

Contractor:

THIS DRAWING IS THE PROPERTY OF FABRAL, INC. THE USE OF THIS DRAWING WITHOUT THE EXPRESS PERMISSION OF FABRAL IS PROHIBITED.

**FABRAL, INC.**  
 3449 Hempland Road  
 Lancaster, PA 17601  
 800-477-2741

**SIDEWALL DETAIL (SW-2)**

**POWER SEAM**

Issued:  
 APRIL 2012

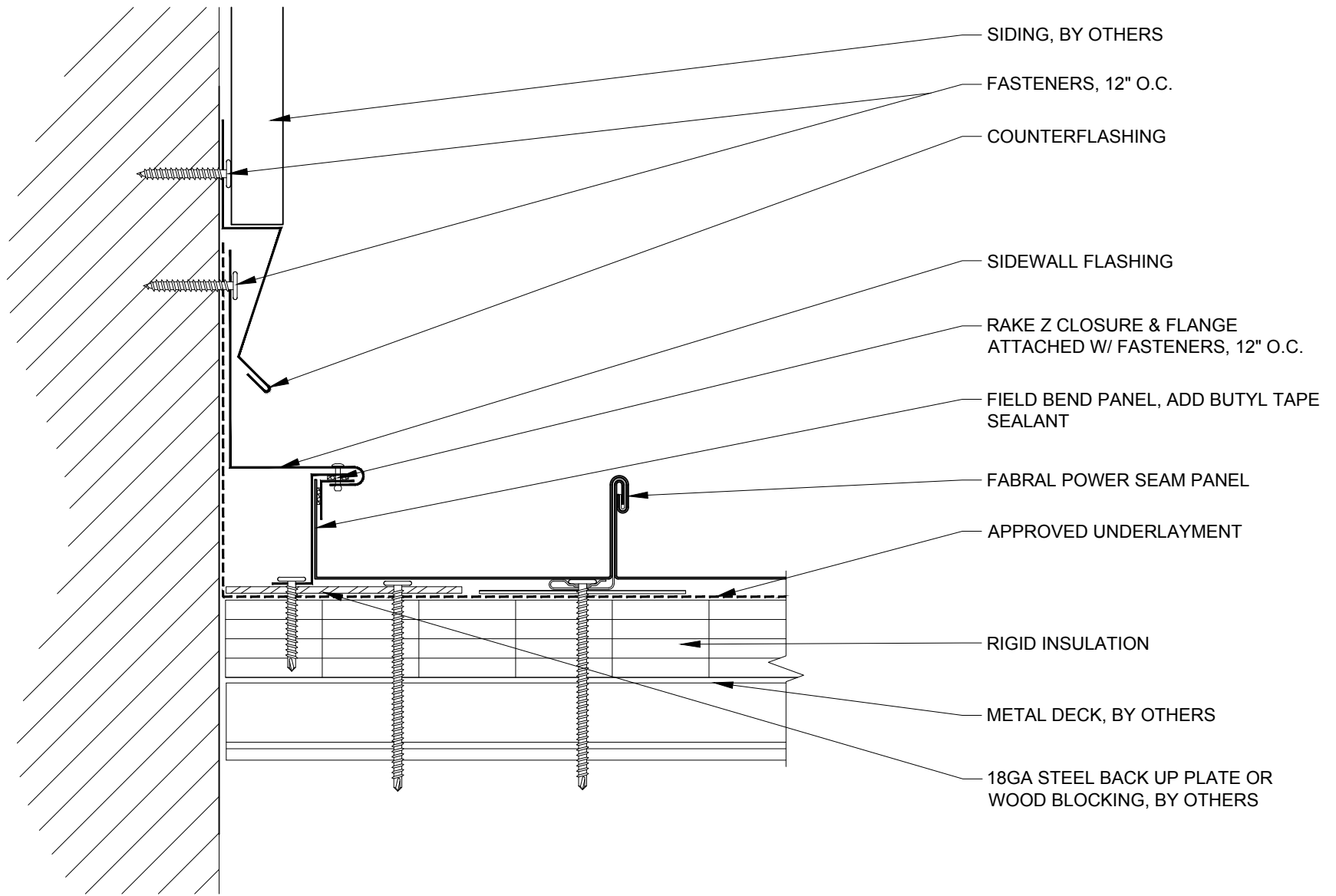

**FABRAL**

Project:

Contractor:

THIS DRAWING IS THE PROPERTY OF FABRAL, INC. THE USE OF THIS DRAWING WITHOUT THE EXPRESS PERMISSION OF FABRAL IS PROHIBITED.

**FABRAL, INC.**  
 3449 Hempland Road  
 Lancaster, PA 17601  
 800-477-2741

**SIDEWALL DETAIL (SW-3)**

**POWER SEAM**

Issued:  
 APRIL 2012