

**FABRAL**

Project: \_\_\_\_\_

Contractor: \_\_\_\_\_

THIS DRAWING IS THE PROPERTY OF FABRAL, INC. THE USE OF THIS DRAWING WITHOUT THE EXPRESS PERMISSION OF FABRAL IS PROHIBITED.

**FABRAL, INC.**  
 3449 Hempland Road  
 Lancaster, PA 17601  
 800-477-2741

**FIXED HIP/RIDGE DETAIL (HR-1)**

**STAND 'N SEAM**

Issued:  
 APRIL 2012

NOT USED

**FABRAL**

Project:

Contractor:

THIS DRAWING IS THE  
PROPERTY OF FABRAL,  
INC. THE USE OF THIS  
DRAWING WITHOUT THE  
EXPRESS PERMISSION OF  
FABRAL IS PROHIBITED.

**FABRAL, INC.**  
3449 Hempland Road  
Lancaster, PA 17601  
800-477-2741

**STAND 'N SEAM**

Issued:

APRIL 2012

NOT USED

**FABRAL**

Project:

Contractor:

THIS DRAWING IS THE  
PROPERTY OF FABRAL,  
INC. THE USE OF THIS  
DRAWING WITHOUT THE  
EXPRESS PERMISSION OF  
FABRAL IS PROHIBITED.

**FABRAL, INC.**  
3449 Hempland Road  
Lancaster, PA 17601  
800-477-2741

**STAND 'N SEAM**

Issued:

APRIL 2012

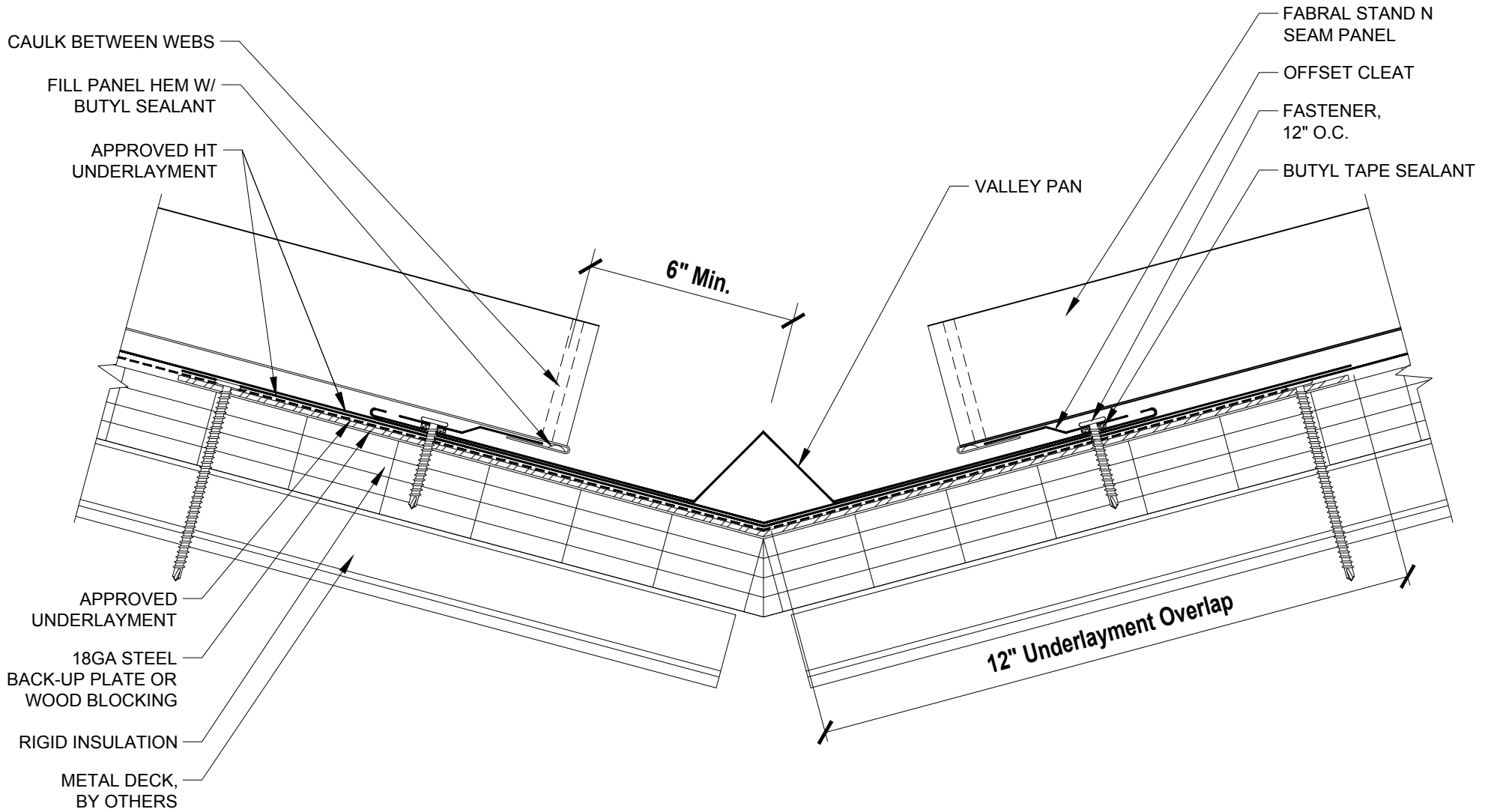

**FABRAL**

Project:

Contractor:

THIS DRAWING IS THE  
PROPERTY OF FABRAL,  
INC. THE USE OF THIS  
DRAWING WITHOUT THE  
EXPRESS PERMISSION OF  
FABRAL IS PROHIBITED.

**FABRAL, INC.**  
3449 Hempland Road  
Lancaster, PA 17601  
800-477-2741

**VALLEY DETAIL (V-1)**

**STAND 'N SEAM**

Issued:  
APRIL 2012

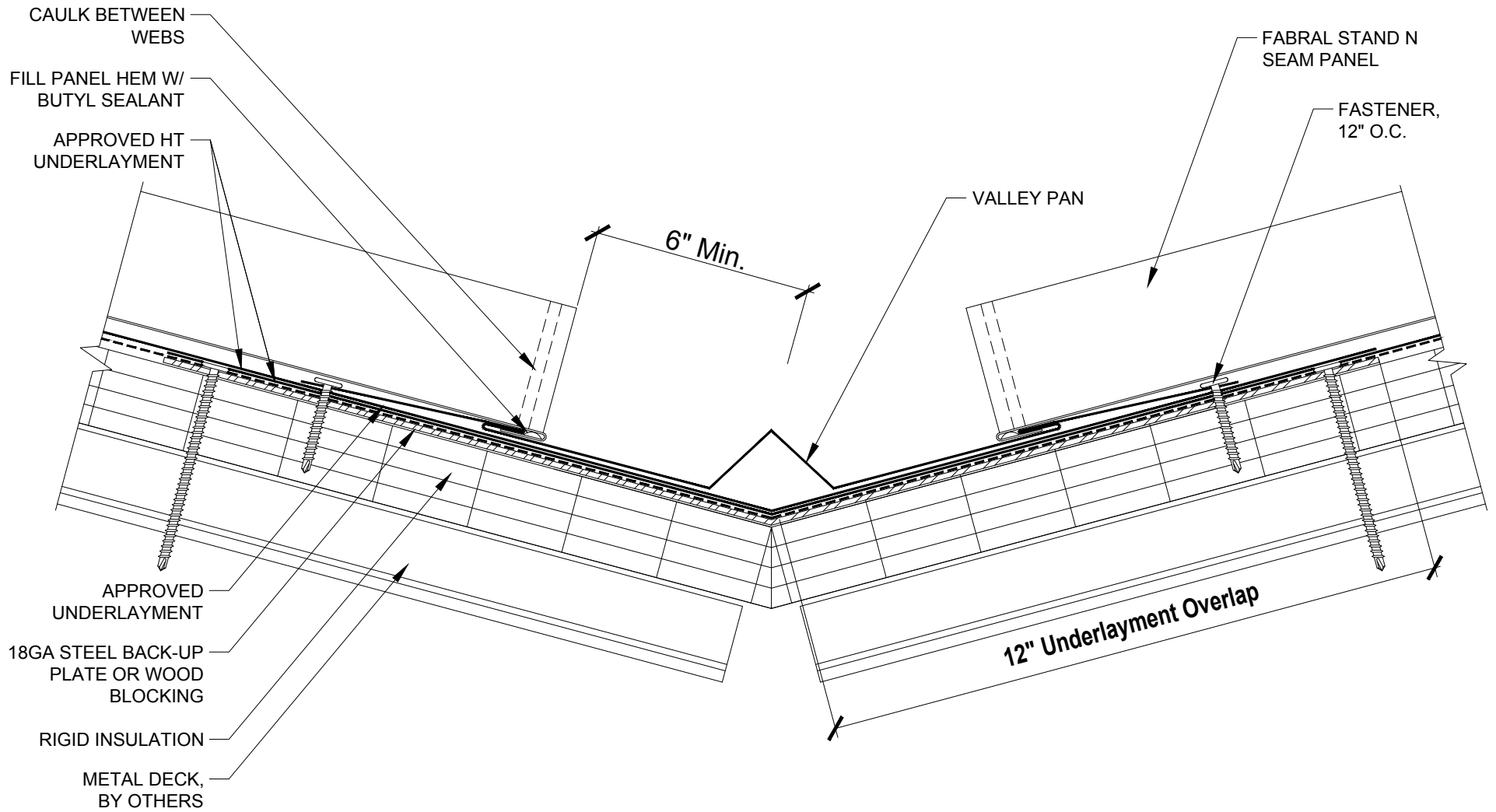

**FABRAL**

Project:

Contractor:

THIS DRAWING IS THE PROPERTY OF FABRAL, INC. THE USE OF THIS DRAWING WITHOUT THE EXPRESS PERMISSION OF FABRAL IS PROHIBITED.

**FABRAL, INC.**  
 3449 Hempland Road  
 Lancaster, PA 17601  
 800-477-2741

**VALLEY DETAIL (V-2)**

**STAND 'N SEAM**

Issued:  
 APRIL 2012

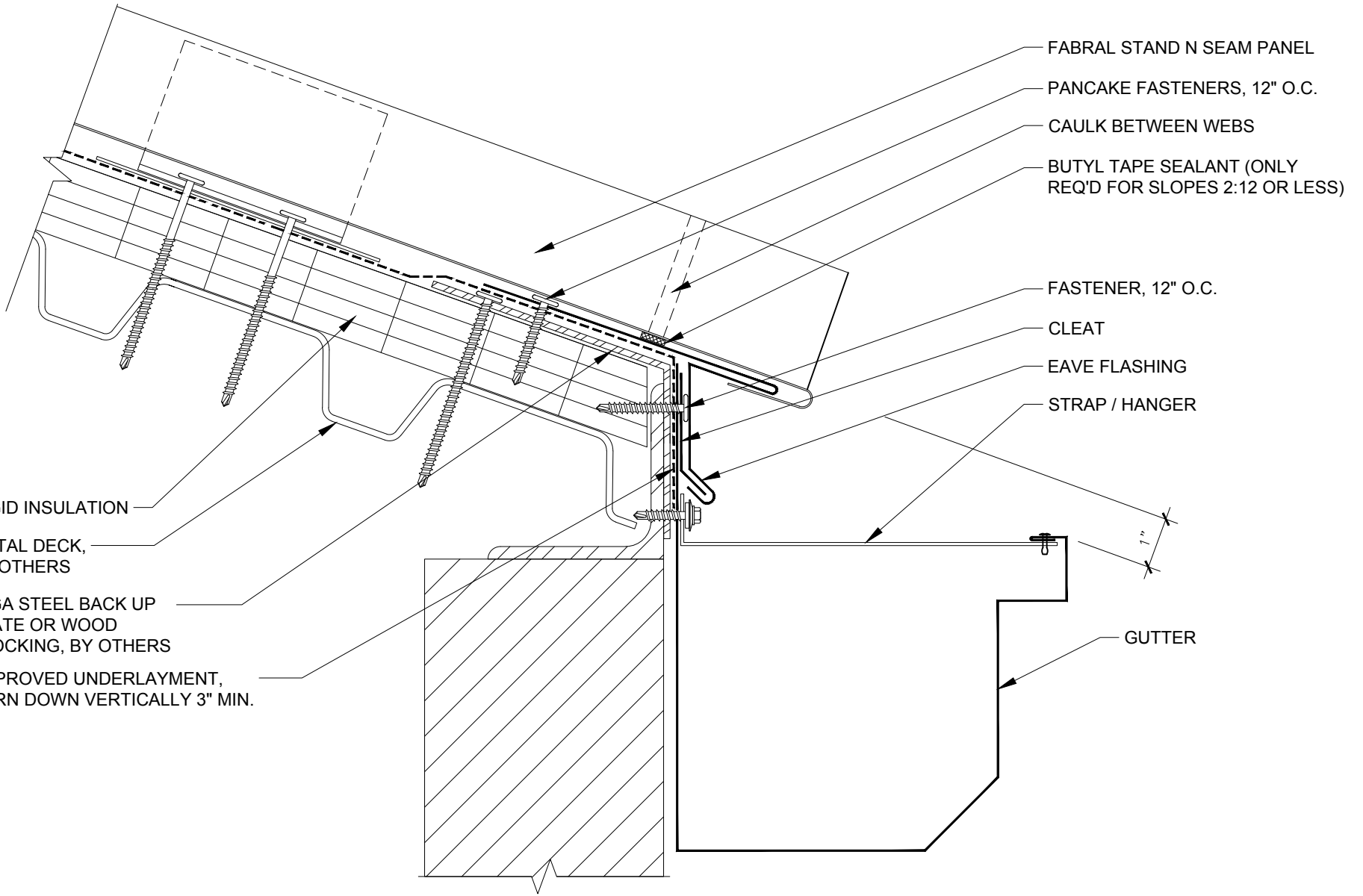

**FABRAL**

Project:

Contractor:

**SLIDING EAVE W/ GUTTER DETAIL (EG-1)**

THIS DRAWING IS THE PROPERTY OF FABRAL, INC. THE USE OF THIS DRAWING WITHOUT THE EXPRESS PERMISSION OF FABRAL IS PROHIBITED.

**FABRAL, INC.**  
 3449 Hempland Road  
 Lancaster, PA 17601  
 800-477-2741

**STAND 'N SEAM**

Issued:

APRIL 2012

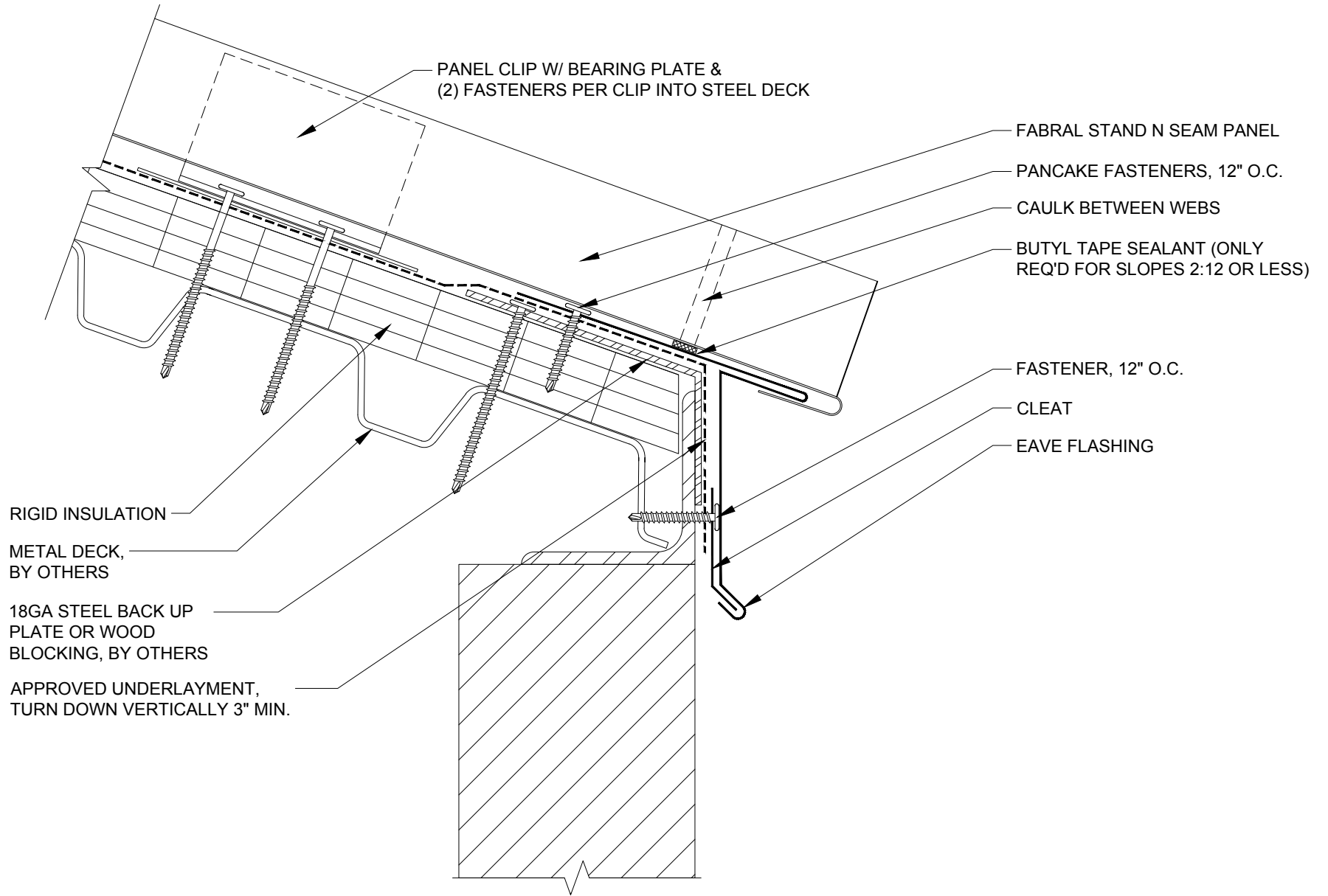

**FABRAL**

Project:

Contractor:

THIS DRAWING IS THE PROPERTY OF FABRAL, INC. THE USE OF THIS DRAWING WITHOUT THE EXPRESS PERMISSION OF FABRAL IS PROHIBITED.

**FABRAL, INC.**  
 3449 Hempland Road  
 Lancaster, PA 17601  
 800-477-2741

**SLIDING EAVE DETAIL (E-1)**

**STAND 'N SEAM**

Issued:  
 APRIL 2012

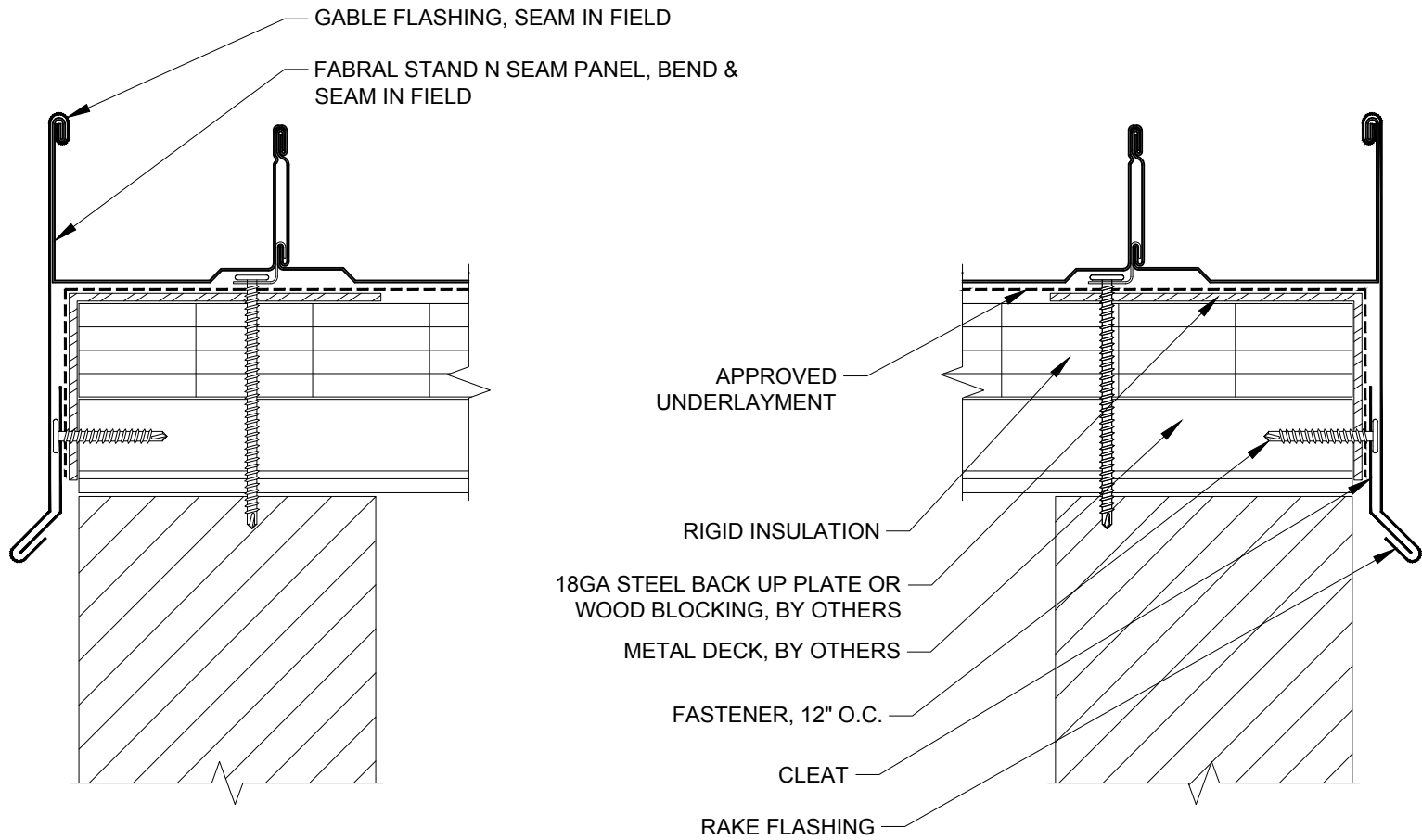

**FABRAL**

Project:

Contractor:

THIS DRAWING IS THE PROPERTY OF FABRAL, INC. THE USE OF THIS DRAWING WITHOUT THE EXPRESS PERMISSION OF FABRAL IS PROHIBITED.

**FABRAL, INC.**  
 3449 Hempland Road  
 Lancaster, PA 17601  
 800-477-2741

**SLIDING GABLE DETAIL (G-1)**

**STAND 'N SEAM**

Issued:  
 APRIL 2012



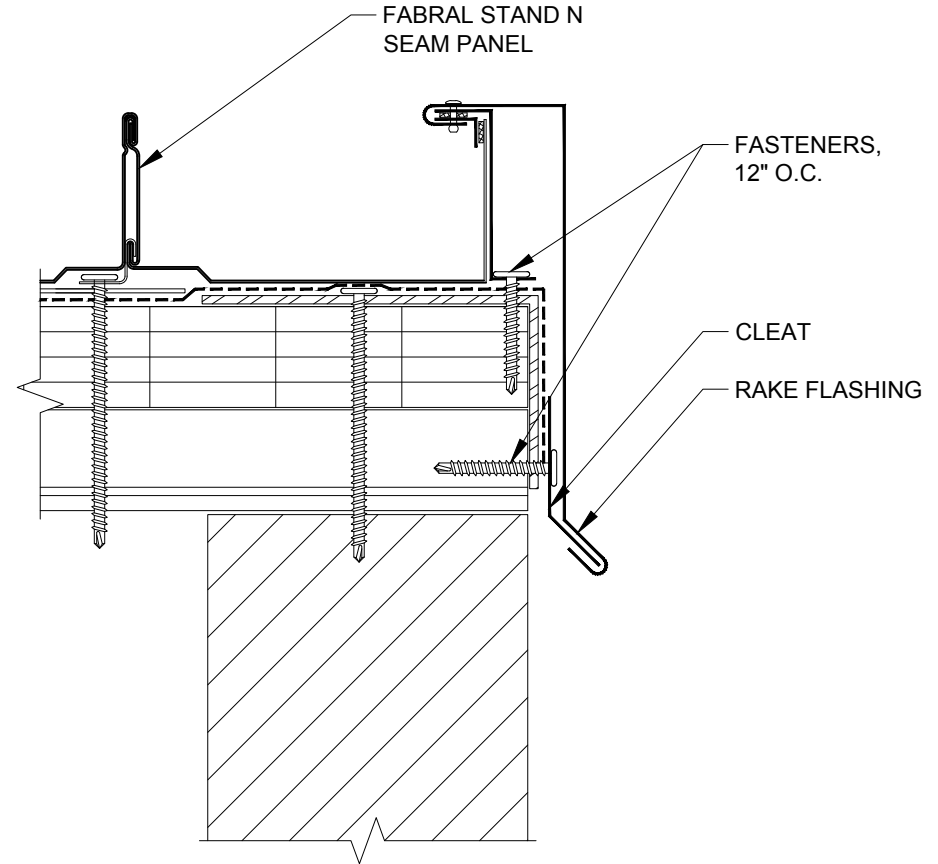
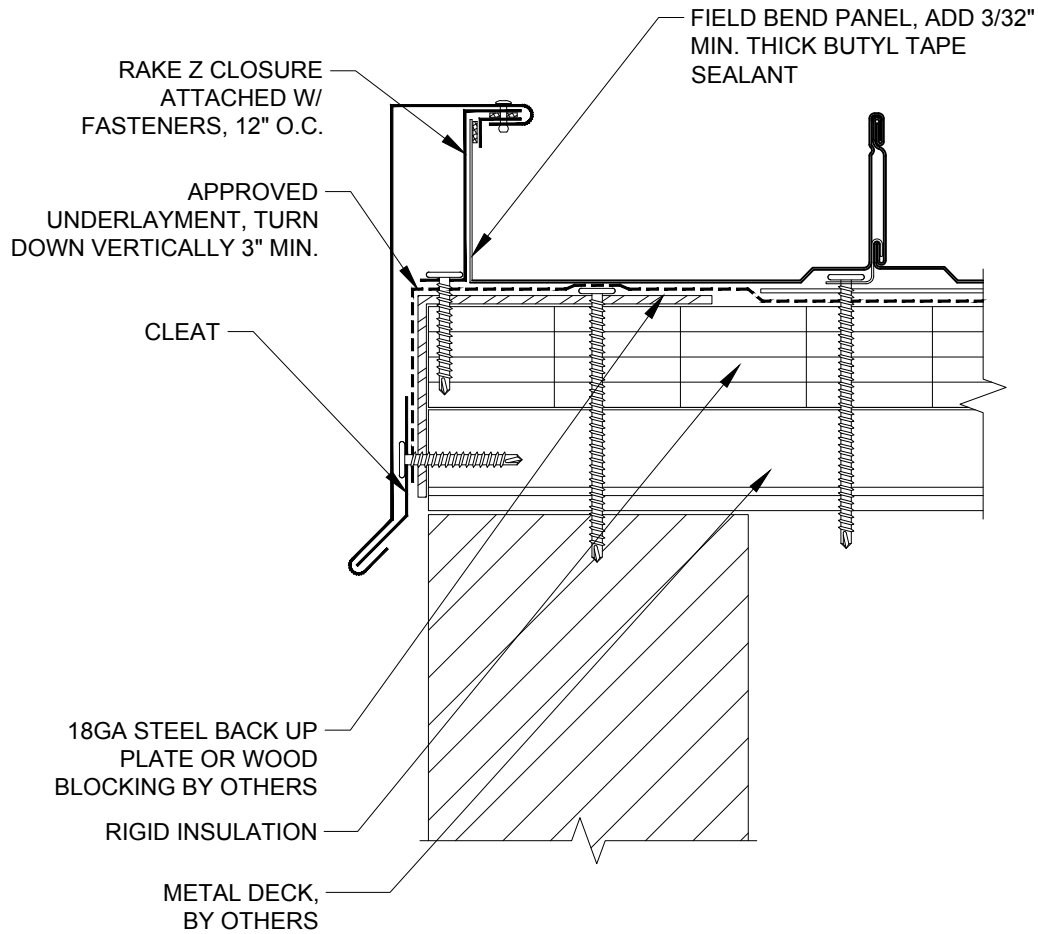

**FABRAL**

Project:

Contractor:

THIS DRAWING IS THE PROPERTY OF FABRAL, INC. THE USE OF THIS DRAWING WITHOUT THE EXPRESS PERMISSION OF FABRAL IS PROHIBITED.

**FABRAL, INC.**  
 3449 Hempland Road  
 Lancaster, PA 17601  
 800-477-2741

**SLIDING GABLE DETAIL (G-2)**

**STAND 'N SEAM**

Issued:  
 APRIL 2012

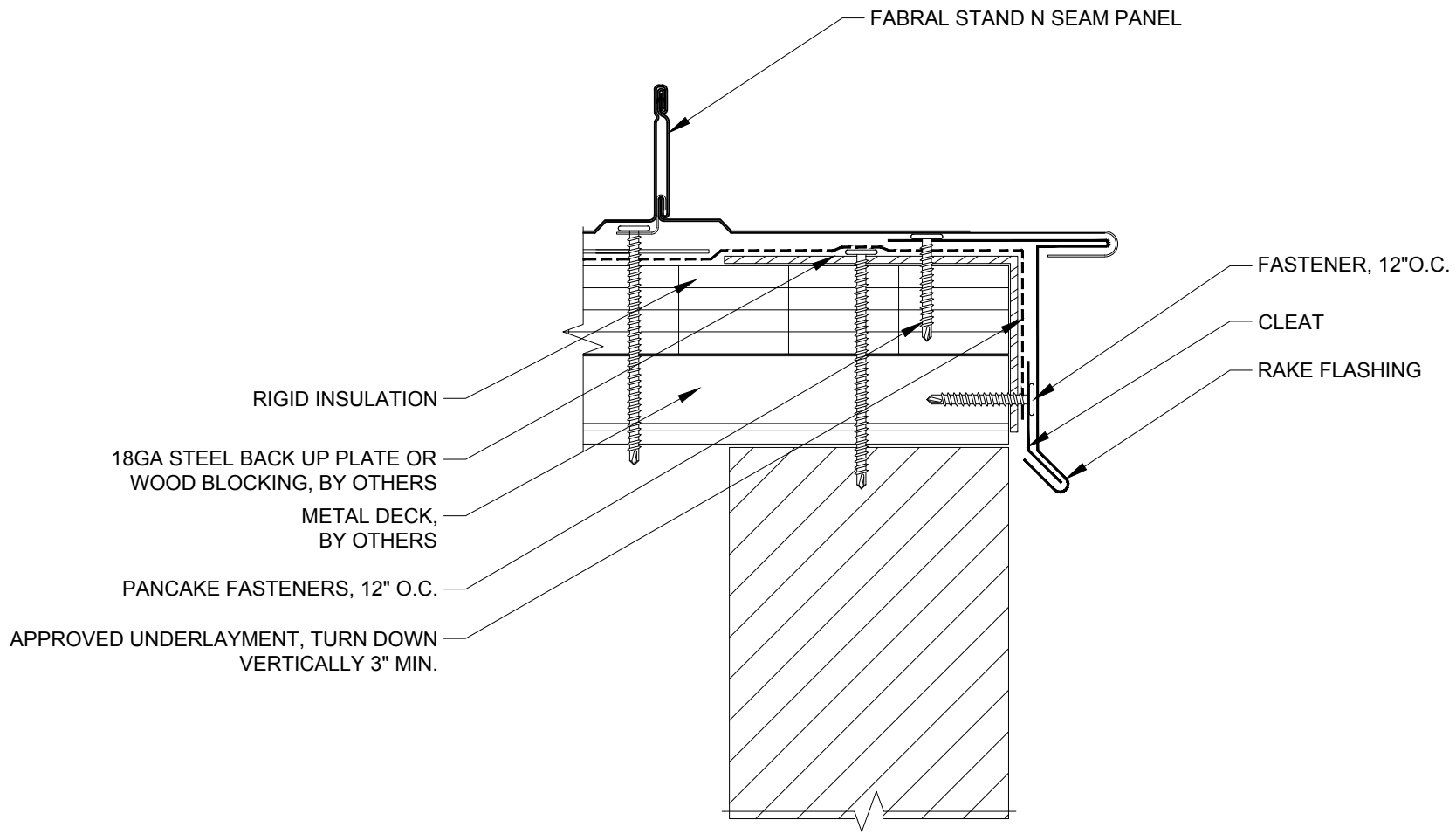

**FABRAL**

Project:

Contractor:

THIS DRAWING IS THE PROPERTY OF FABRAL, INC. THE USE OF THIS DRAWING WITHOUT THE EXPRESS PERMISSION OF FABRAL IS PROHIBITED.

**FABRAL, INC.**  
 3449 Hempland Road  
 Lancaster, PA 17601  
 800-477-2741

**SLIDING GABLE DETAIL (G-3)**

**STAND 'N SEAM**

Issued:  
 APRIL 2012

FABRAL STAND 'N SEAM PANEL,  
BOX PANEL END

FASTENER, 12" O.C.

BUTYL TAPE SEALANT

Z CLOSURE CUT TO FIT, SET IN  
BUTYL TAPE SEALANT, (5)  
FASTENERS PER PANEL. FILL ALL  
VOIDS WITH APPROVED SEALANT.

PANEL CLIP W/ BEARING  
PLATE & (2) FASTENERS  
PER CLIP INTO STEEL DECK

RIGID INSULATION

METAL DECK BY OTHERS

18GA STEEL BACK UP PLATE  
OR WOOD BLOCKING  
BY OTHERS

PEAK FLASHING

APPROVED SEALANT

FABRAL STAND 'N SEAM PANEL, BOX  
PANEL END

APPROVED UNDERLAYMENT, TURN  
DOWN VERTICALLY 3" MIN.

SD FASTENERS,  
(5) PER PANEL

APPROVED SEALANT

Z CLOSURE SET IN BUTYL TAPE  
SEALANT ATTACHED W/ (5)  
FASTENERS PER PANEL

**FABRAL**

Project:

Contractor:

THIS DRAWING IS THE  
PROPERTY OF FABRAL,  
INC. THE USE OF THIS  
DRAWING WITHOUT THE  
EXPRESS PERMISSION OF  
FABRAL IS PROHIBITED.

**FABRAL, INC.**  
3449 Hempland Road  
Lancaster, PA 17601  
800-477-2741

**HIGH SIDE EAVE DETAIL (HSE-1)**

**STAND 'N SEAM**

Issued:

APRIL 2012

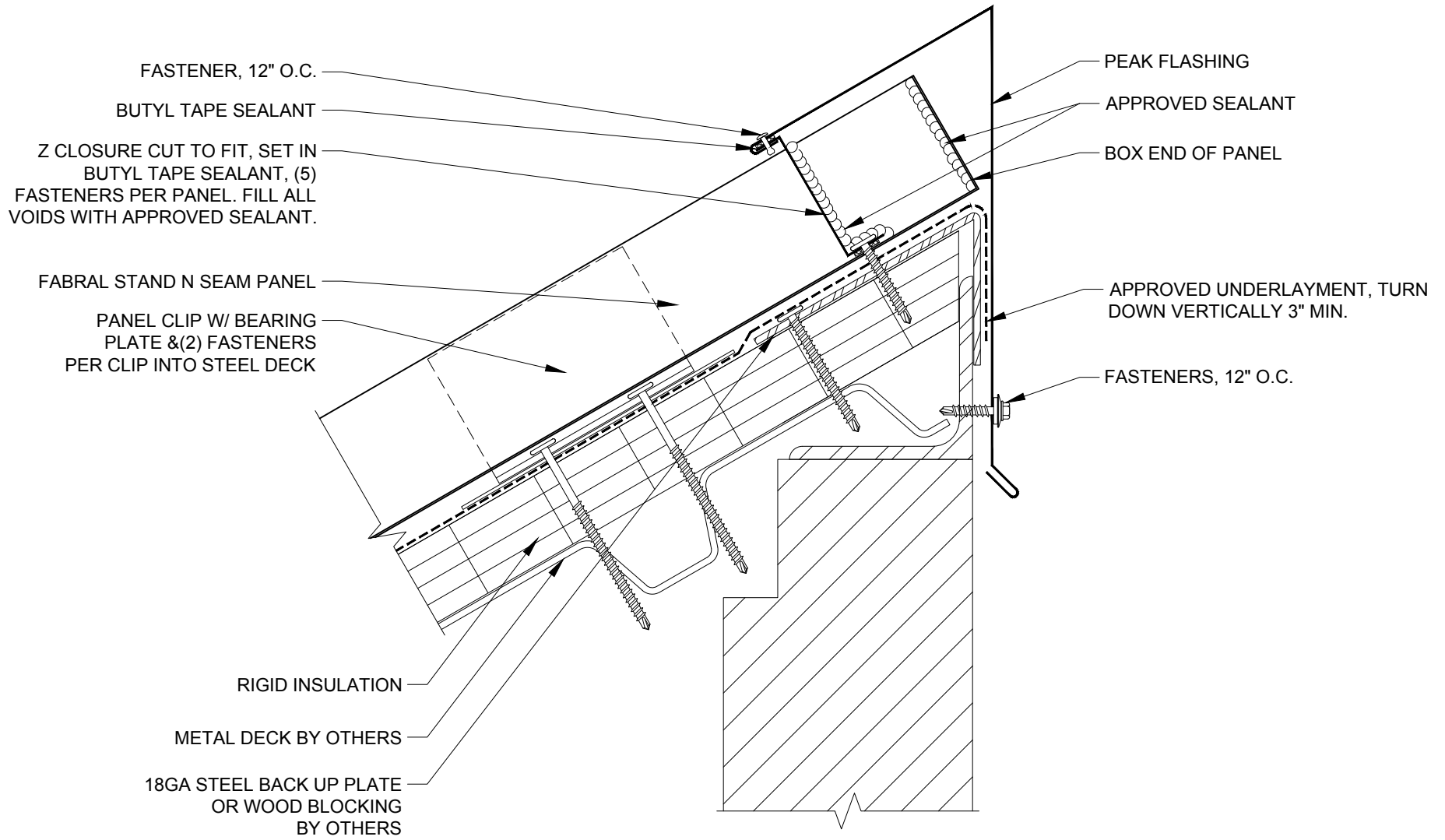

**FABRAL**

Project:

Contractor:

THIS DRAWING IS THE PROPERTY OF FABRAL, INC. THE USE OF THIS DRAWING WITHOUT THE EXPRESS PERMISSION OF FABRAL IS PROHIBITED.

**FABRAL, INC.**  
 3449 Hempland Road  
 Lancaster, PA 17601  
 800-477-2741

**HIGH SIDE EAVE DETAIL (HSE-2)**

**STAND 'N SEAM**

Issued:  
 APRIL 2012

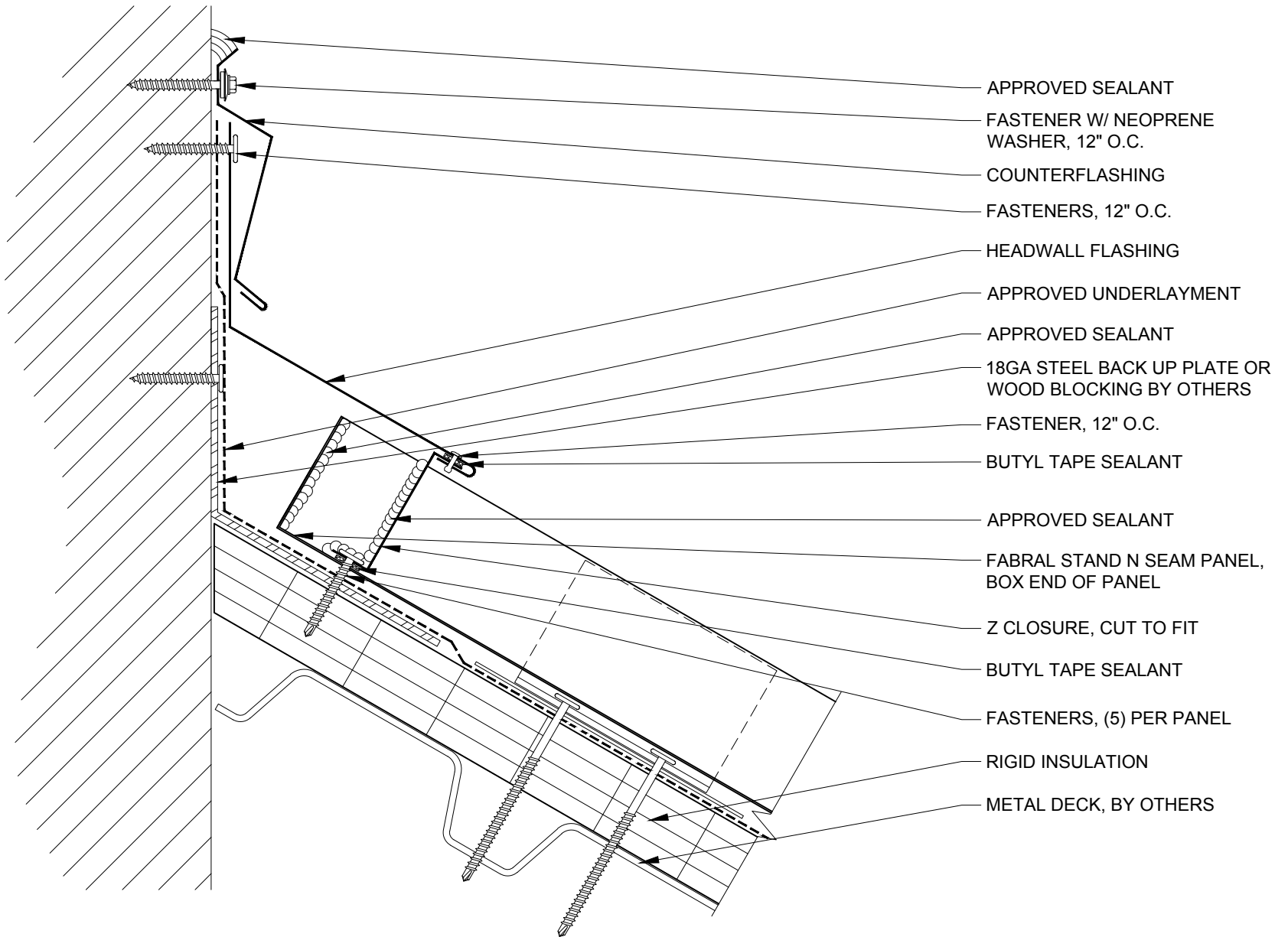

**FABRAL**

Project:

Contractor:

THIS DRAWING IS THE PROPERTY OF FABRAL, INC. THE USE OF THIS DRAWING WITHOUT THE EXPRESS PERMISSION OF FABRAL IS PROHIBITED.

**FABRAL, INC.**  
 3449 Hempland Road  
 Lancaster, PA 17601  
 800-477-2741

**HEADWALL DETAIL (HW-1)**

**STAND 'N SEAM**

Issued:  
 APRIL 2012

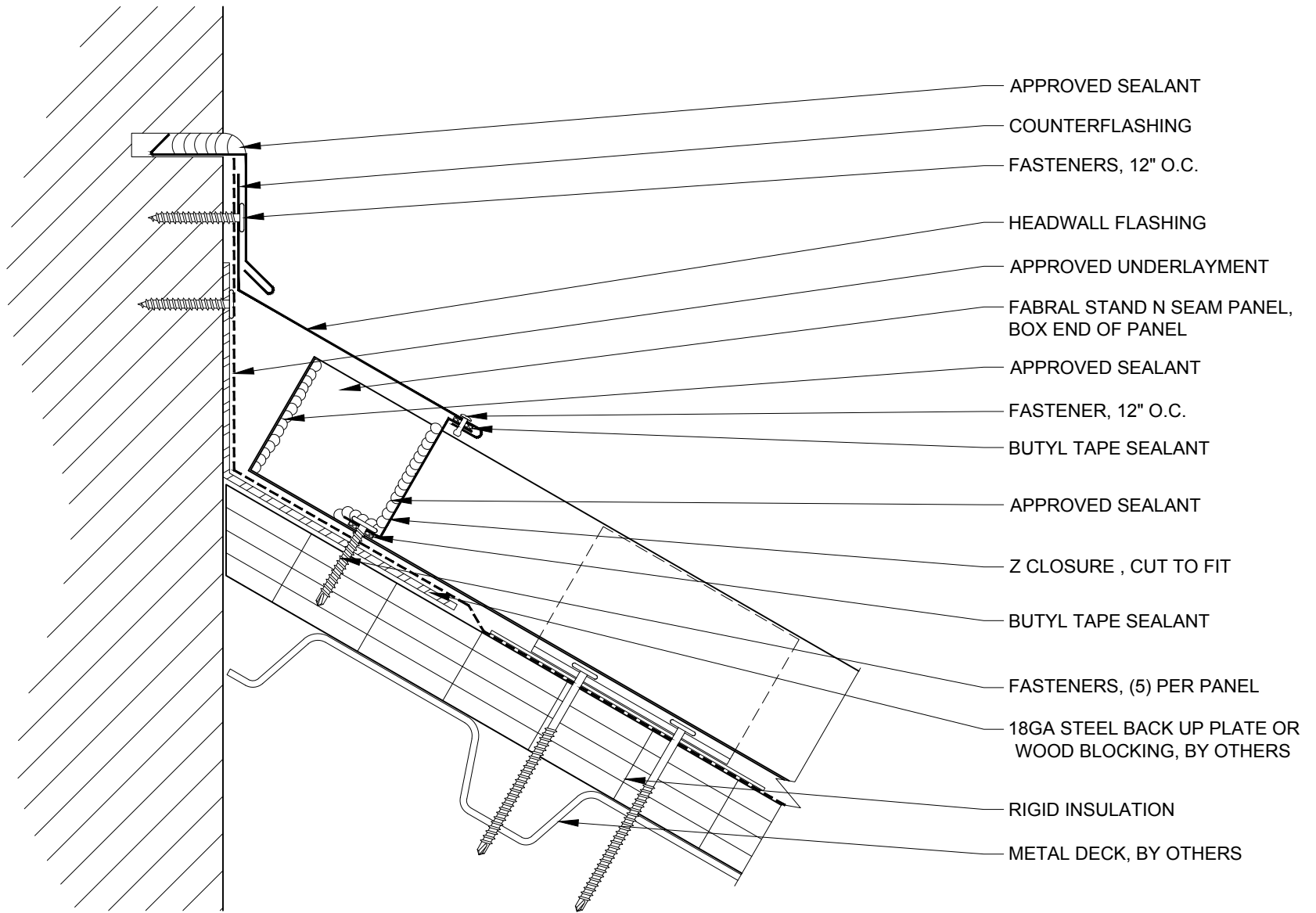

**FABRAL**

Project: \_\_\_\_\_  
 Contractor: \_\_\_\_\_

THIS DRAWING IS THE PROPERTY OF FABRAL, INC. THE USE OF THIS DRAWING WITHOUT THE EXPRESS PERMISSION OF FABRAL IS PROHIBITED.

**FABRAL, INC.**  
 3449 Hempland Road  
 Lancaster, PA 17601  
 800-477-2741

**HEADWALL DETAIL (HW-2)**

**STAND 'N SEAM**

Issued:  
 APRIL 2012

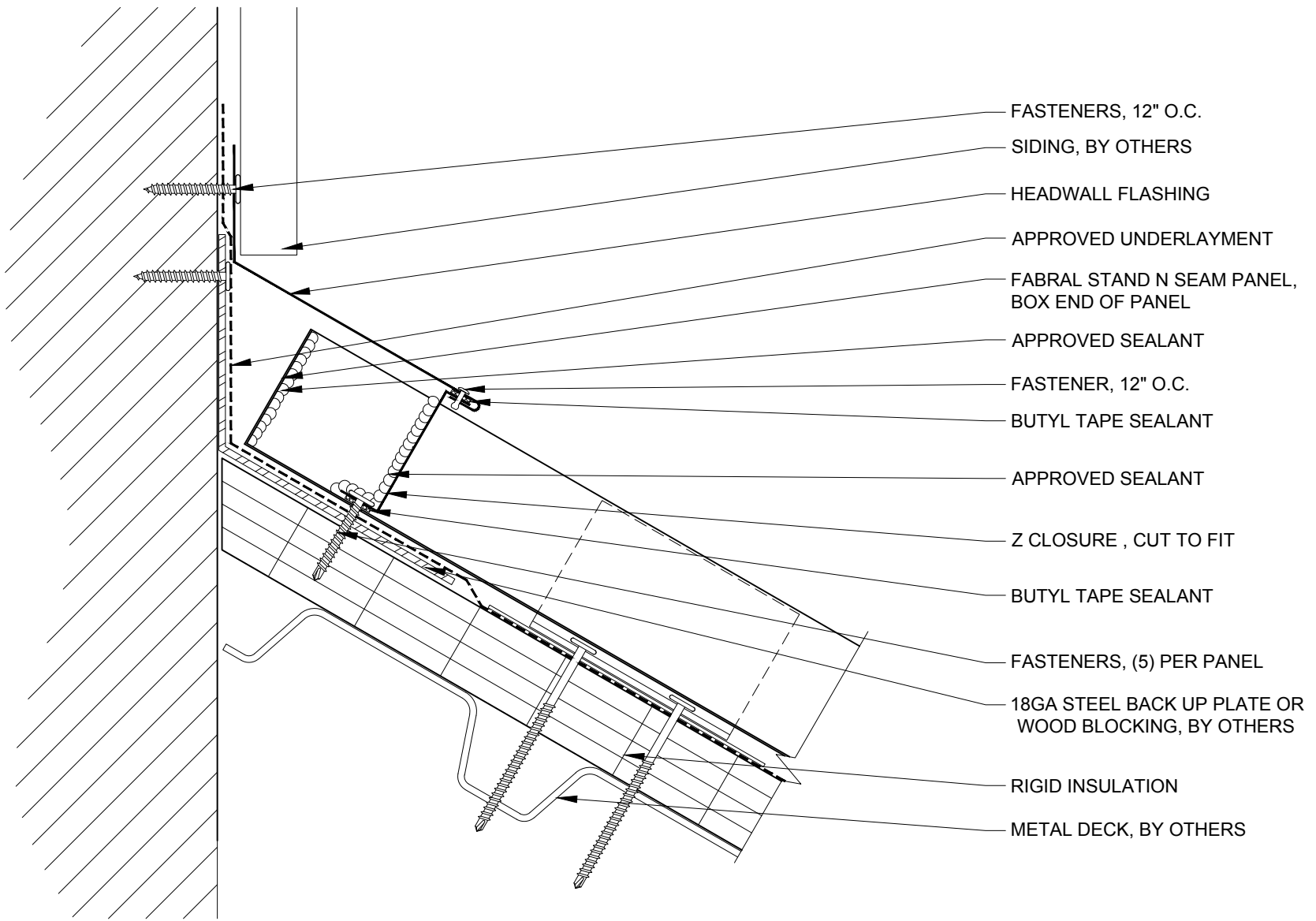

- FASTENERS, 12" O.C.
- SIDING, BY OTHERS
- HEADWALL FLASHING
- APPROVED UNDERLAYMENT
- FABRAL STAND 'N SEAM PANEL, BOX END OF PANEL
- APPROVED SEALANT
- FASTENER, 12" O.C.
- BUTYL TAPE SEALANT
- APPROVED SEALANT
- Z CLOSURE , CUT TO FIT
- BUTYL TAPE SEALANT
- FASTENERS, (5) PER PANEL
- 18GA STEEL BACK UP PLATE OR WOOD BLOCKING, BY OTHERS
- RIGID INSULATION
- METAL DECK, BY OTHERS

**FABRAL**

Project:

Contractor:

THIS DRAWING IS THE PROPERTY OF FABRAL, INC. THE USE OF THIS DRAWING WITHOUT THE EXPRESS PERMISSION OF FABRAL IS PROHIBITED.

**FABRAL, INC.**  
 3449 Hempland Road  
 Lancaster, PA 17601  
 800-477-2741

**HEADWALL DETAIL (HW-3)**

**STAND 'N SEAM**

Issued:  
 APRIL 2012

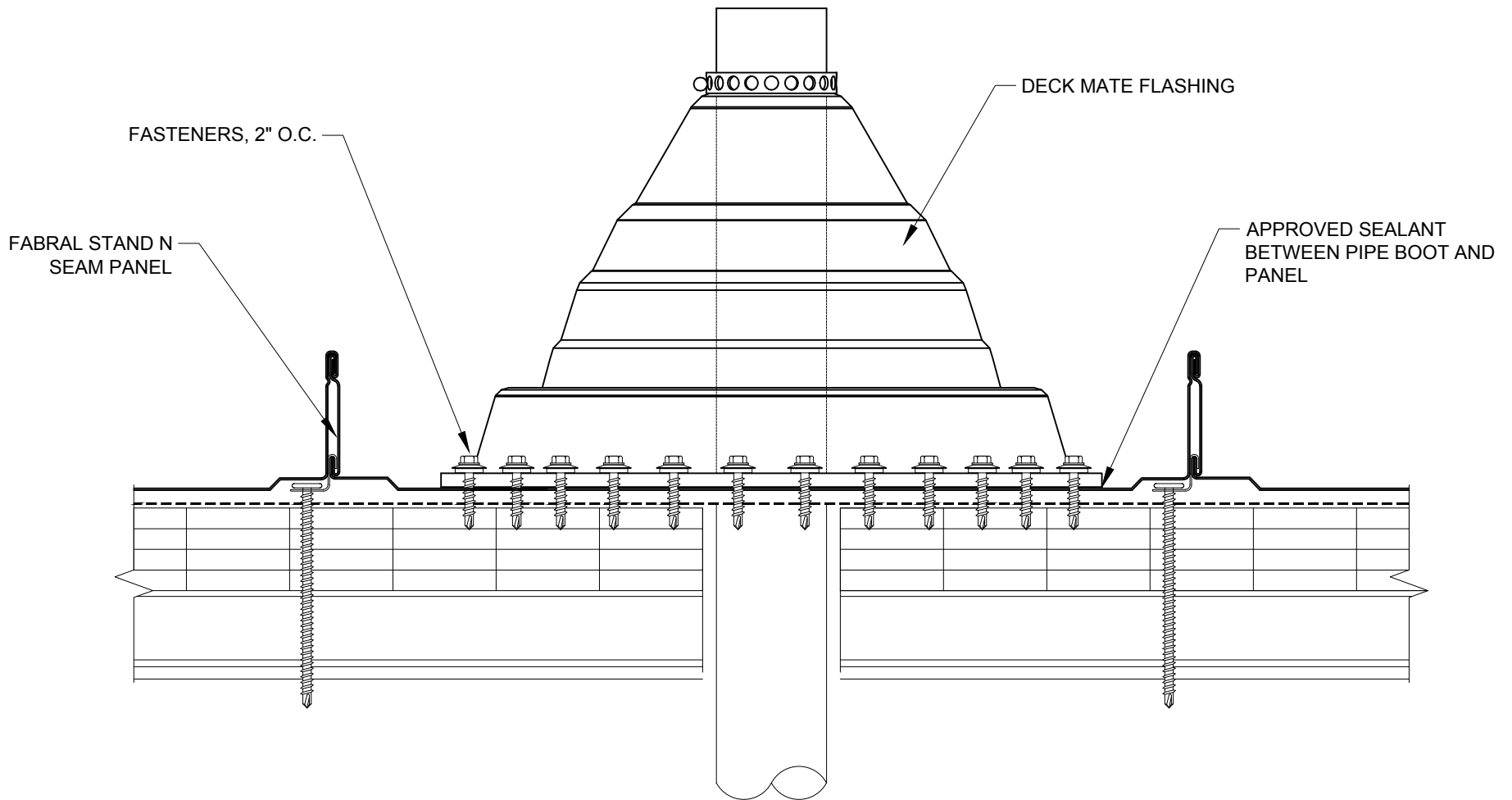

**FABRAL**

Project: \_\_\_\_\_  
 Contractor: \_\_\_\_\_

THIS DRAWING IS THE PROPERTY OF FABRAL, INC. THE USE OF THIS DRAWING WITHOUT THE EXPRESS PERMISSION OF FABRAL IS PROHIBITED.

**FABRAL, INC.**  
 3449 Hempland Road  
 Lancaster, PA 17601  
 800-477-2741

**PENETRATION DETAIL (P-1)**

**STAND 'N SEAM**

Issued:  
 APRIL 2012



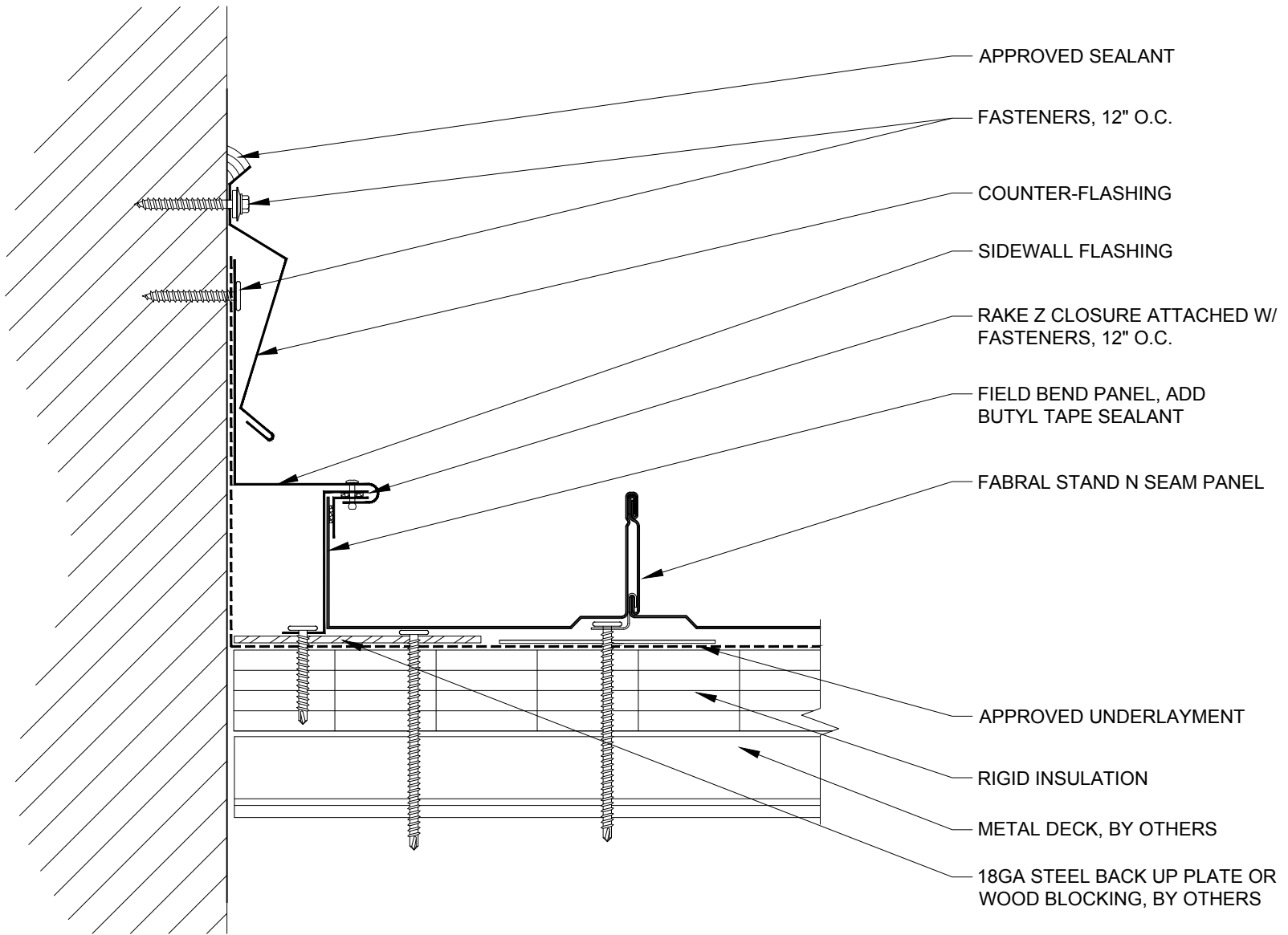

**FABRAL**

Project:

Contractor:

THIS DRAWING IS THE PROPERTY OF FABRAL, INC. THE USE OF THIS DRAWING WITHOUT THE EXPRESS PERMISSION OF FABRAL IS PROHIBITED.

**FABRAL, INC.**  
 3449 Hempland Road  
 Lancaster, PA 17601  
 800-477-2741

**SIDEWALL DETAIL (SW-1)**

**STAND 'N SEAM**

Issued:  
 APRIL 2012

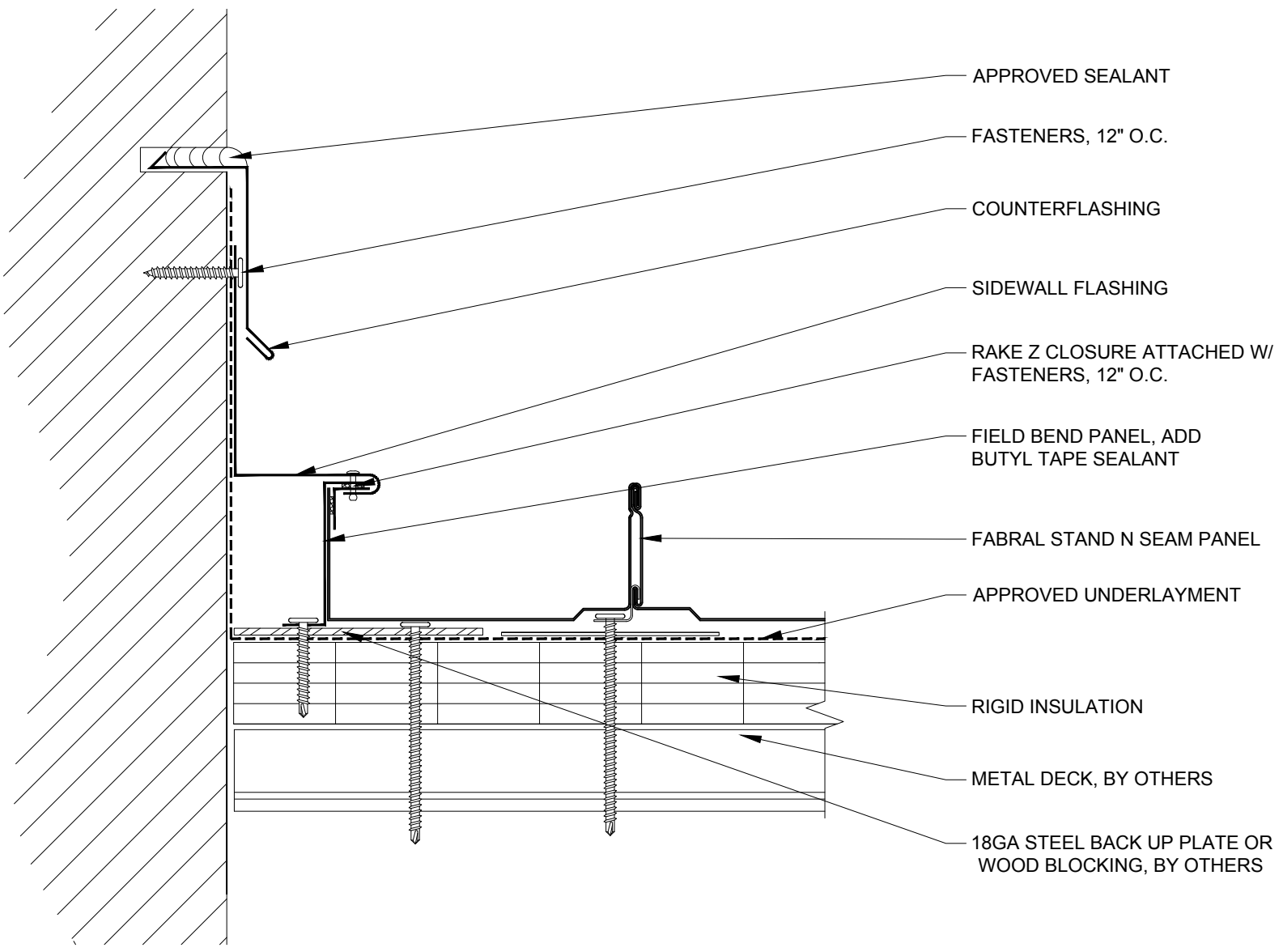

**FABRAL**

Project:

Contractor:

THIS DRAWING IS THE PROPERTY OF FABRAL, INC. THE USE OF THIS DRAWING WITHOUT THE EXPRESS PERMISSION OF FABRAL IS PROHIBITED.

**FABRAL, INC.**  
 3449 Hempland Road  
 Lancaster, PA 17601  
 800-477-2741

**SIDEWALL DETAIL (SW-2)**

**STAND 'N SEAM**

Issued:  
 APRIL 2012

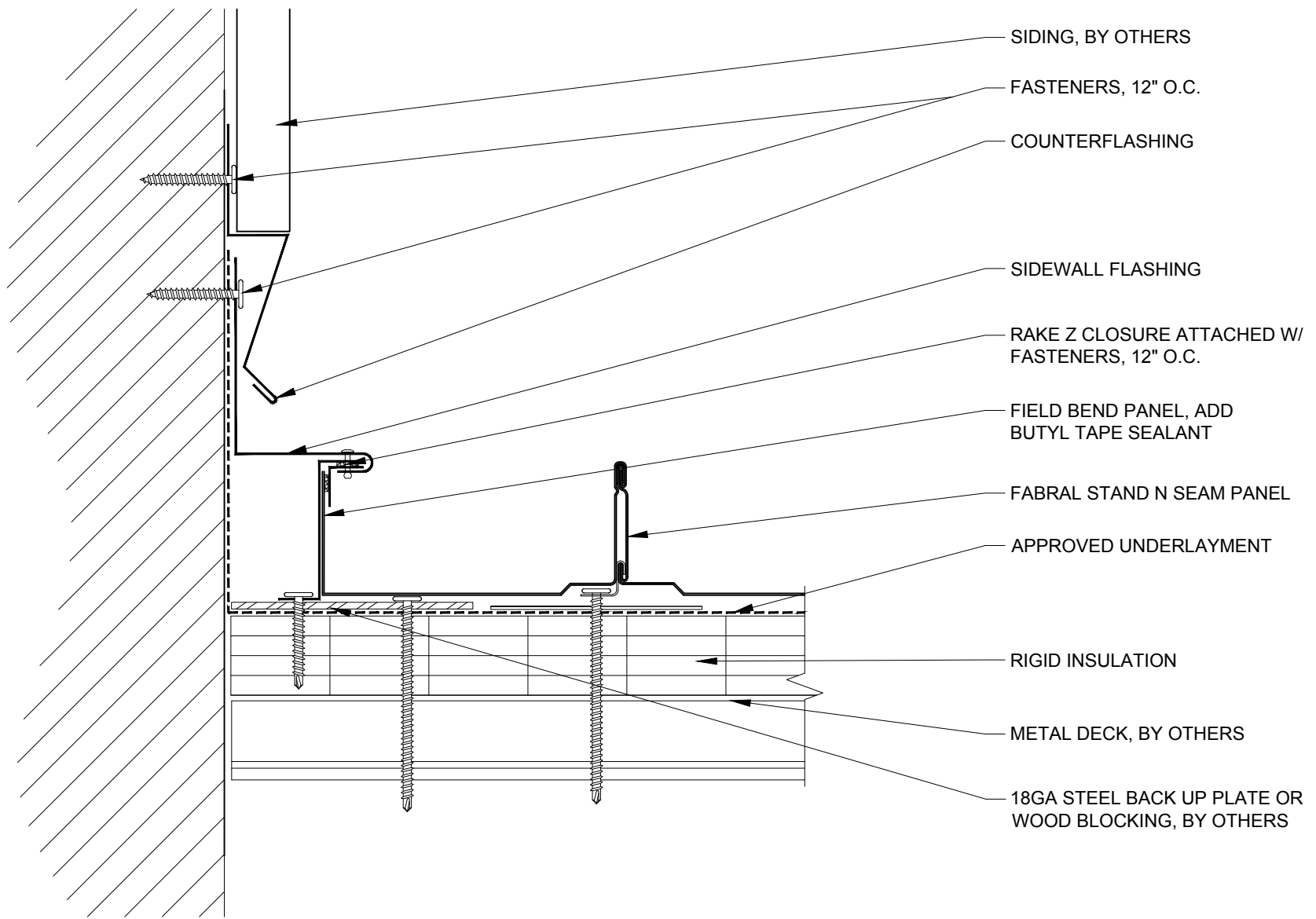

**FABRAL**

Project:

Contractor:

THIS DRAWING IS THE PROPERTY OF FABRAL, INC. THE USE OF THIS DRAWING WITHOUT THE EXPRESS PERMISSION OF FABRAL IS PROHIBITED.

**FABRAL, INC.**  
 3449 Hempland Road  
 Lancaster, PA 17601  
 800-477-2741

**SIDEWALL DETAIL (SW-3)**

**STAND 'N SEAM**

Issued:  
 APRIL 2012