

Notes:

- Two-Rail Option Available
- Panel Ships Completely Assembled
- Pales Through Rails
- 20-year FortressShield Limited Warranty
- Patent Pending

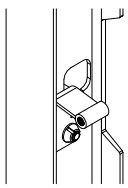

EXR-109

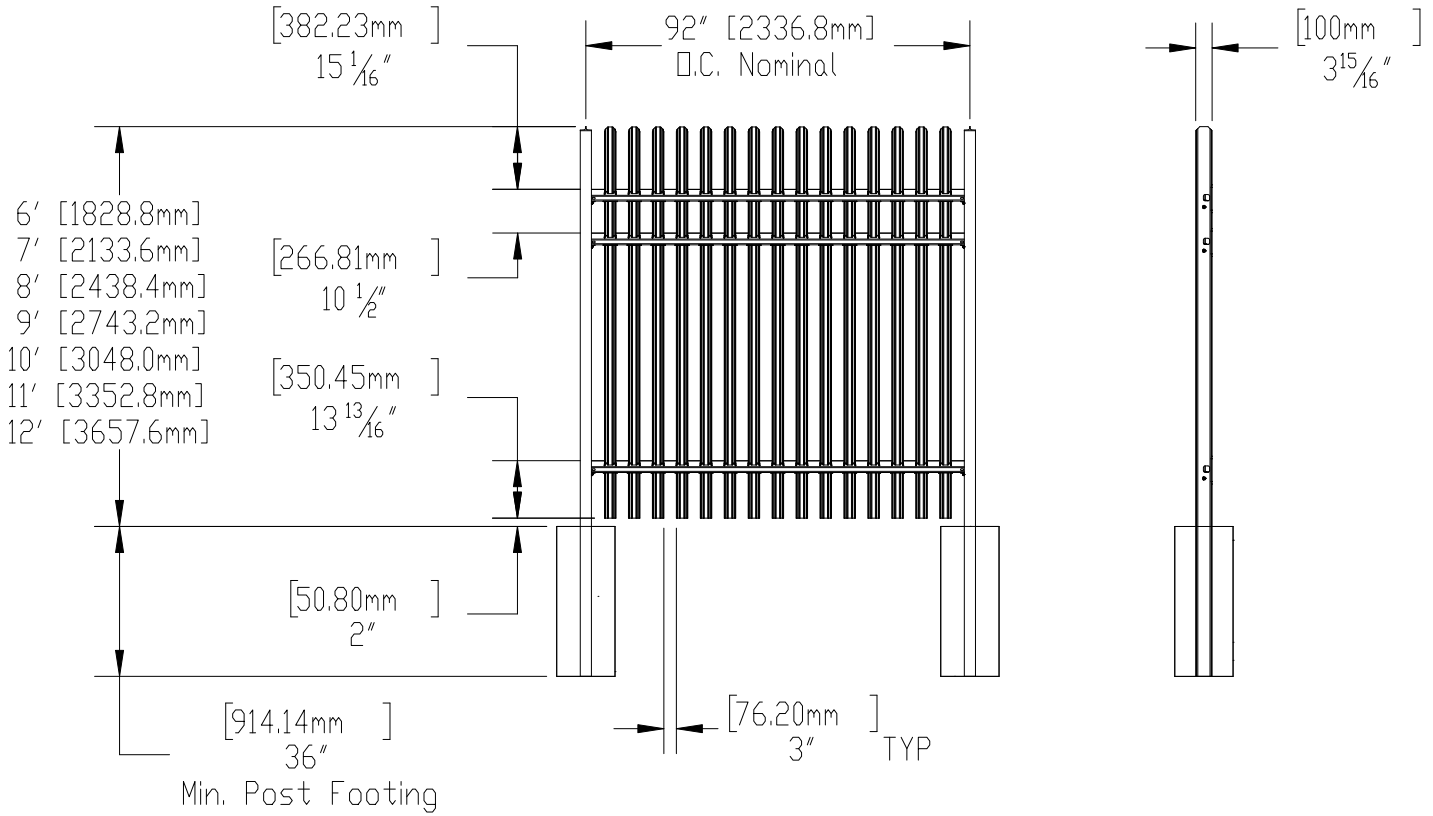
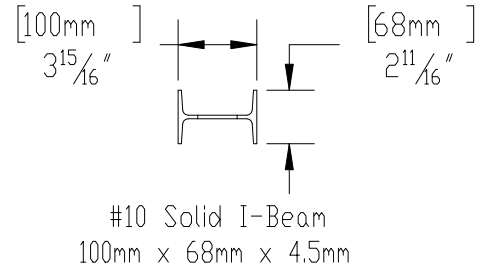
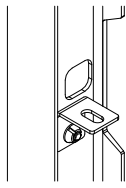

EX-109

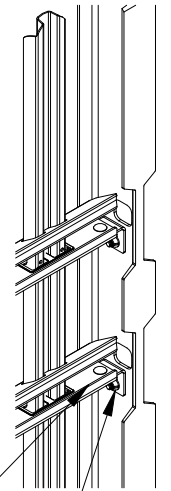
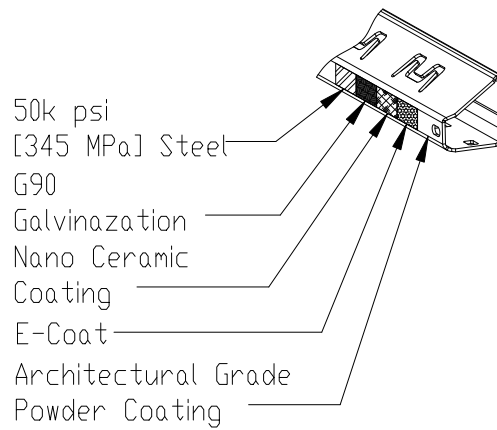
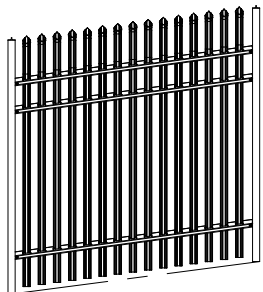

**FORTRESS**  
BUILDING PRODUCTS

Fortress Building Products  
1720 1st Street  
Garland, Tx 75040  
www.fortressbop.com

Style: Scorpio	Description: ARES Scorpio 2 & 3 Rail Panels	
Height:	Rev #: 1	Rev Date: 6/30/20
Panel Length: 90.5in [2298.7mm]	Drawn By: KurtC	
Class: High Security	Date: 7/2/20	Scale: Do Not Scale