

Applicable Bracket (Options):

AL13 Evolve Brackets

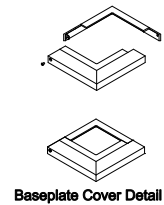
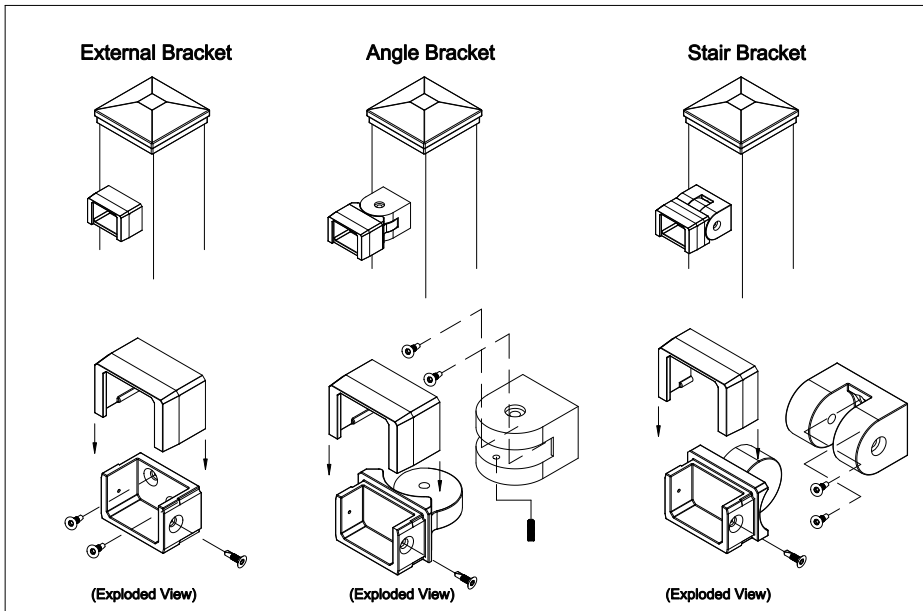

Architectural Grade
Polyester Powder Coat

Chromium Phosphate
Coating

6063T6 Alloy
Extruded Tube

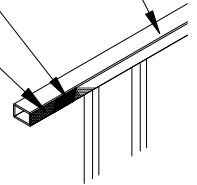

NOTE:
Bracket to Post Connection: T25 3/4" Thread Cutting Screw
Railing Panel to Bracket Connection: T25 3/4" Thread Cutting Screw

The product design contained on this drawing is proprietary to Fortress Iron, LP, Garland, Texas, USA, and is not to be copied electronically or manually, or reproduced in any manner, or divulged to other sources, without the expressed written permission of an authorized representative of Fortress Iron L.P.



Fortress Railing
1720 North 1st Street
Garland, TX 75040
972-231-3038

Style: AL13	Description: Railing	
Height: 34", 40"	Rev #:	Rev Date:
Panel Length: 69"	Scale: Do Not Scale	
Class: Residential	Drawn By: FS	Date: 12/12/13