

**Center to Center Post Spacing
(51.25" Panel)**

**57 1/4" [1454.15mm] (min)
to 62" [1574.8mm] (max)**

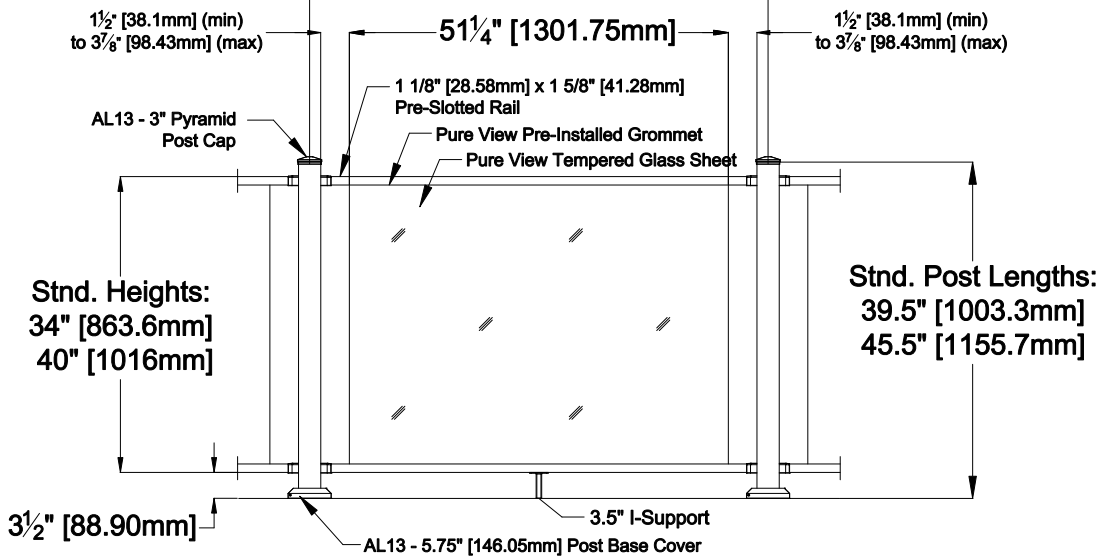

Applicable Bracket (Options):

AL13 Evolve Brackets

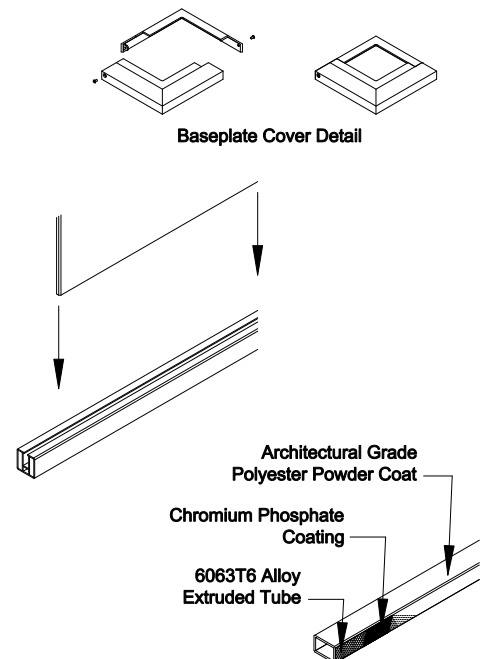
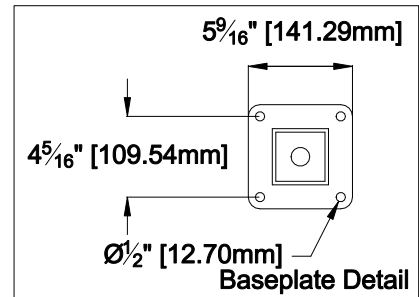
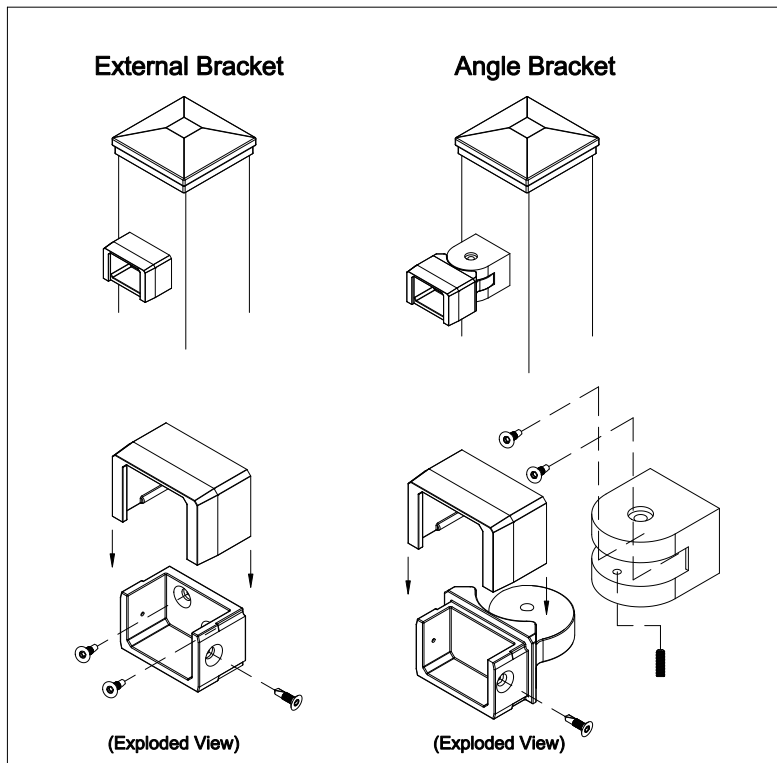

NOTE:
Bracket to Post Connection: T25 3/4" Thread Cutting Screw
Railing Panel to Bracket Connection: T25 3/4" Thread Cutting Screw

The product design contained on this drawing is proprietary to Fortress Iron, LP, Garland, Texas, USA, and is not to be copied electronically or manually, or reproduced in any manner, or divulged to other sources, without the expressed written permission of an authorized representative of Fortress Iron L.P.



Fortress Railing
1720 North 1st Street
Garland, TX 75040
972-231-3038

Style: Pure View Glass Sheet with AL13 rails

Height: 34", 40"

Panel Length: 51.25"

Class: Residential

Rev #:

Rev Date:

Scale: Do Not Scale

Drawn By: FS

Date: 12/12/13