

NOT TO SCALE

FINISHES:

ST. STL. - #4 SATIN
SPECIAL - CONTACT FACTORY

SYSTEM I
SERIES-1000
FLUSH

FULLER PHOENIX ARCHITECTURAL PRODUCTS

713.699.2262

www.fullerphoenix.com

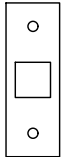
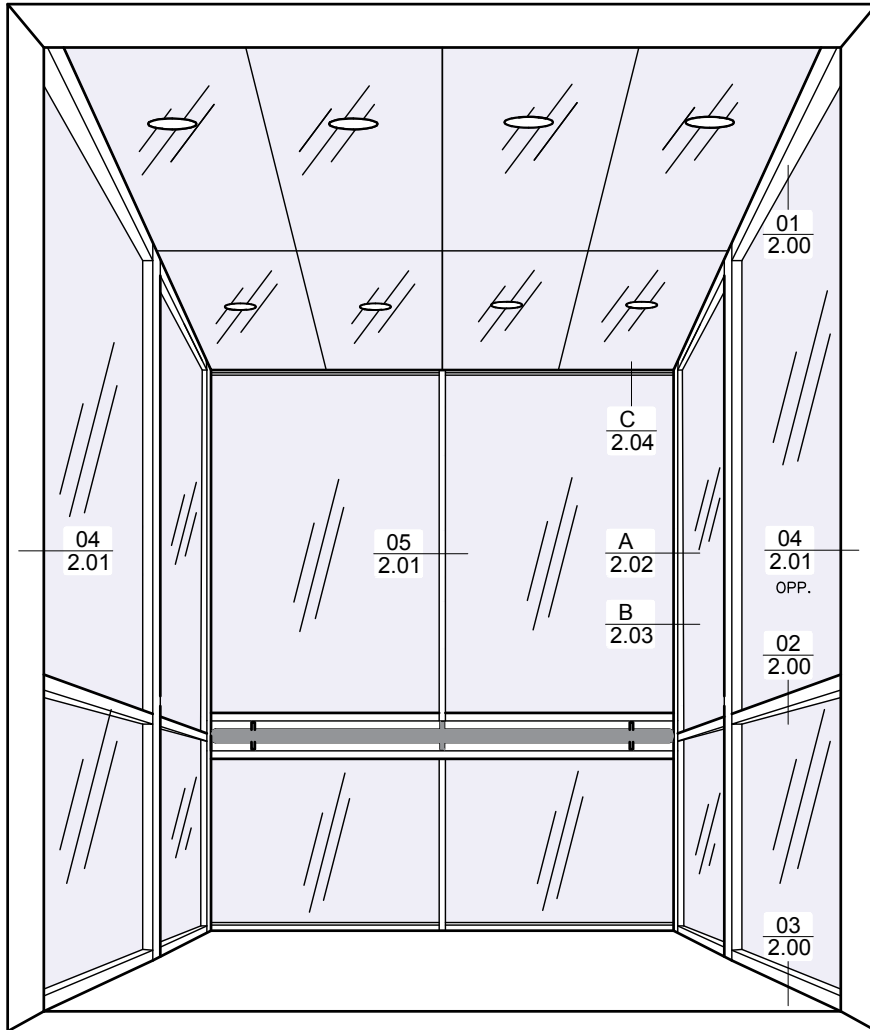

NOT TO SCALE

FINISHES:

ST. STL. - #4 SATIN
SPECIAL - CONTACT FACTORY

SYSTEM I
SERIES-1000 EX
EXTENDED

FULLER PHOENIX ARCHITECTURAL PRODUCTS

713.699.2262

www.fullerphoenix.com

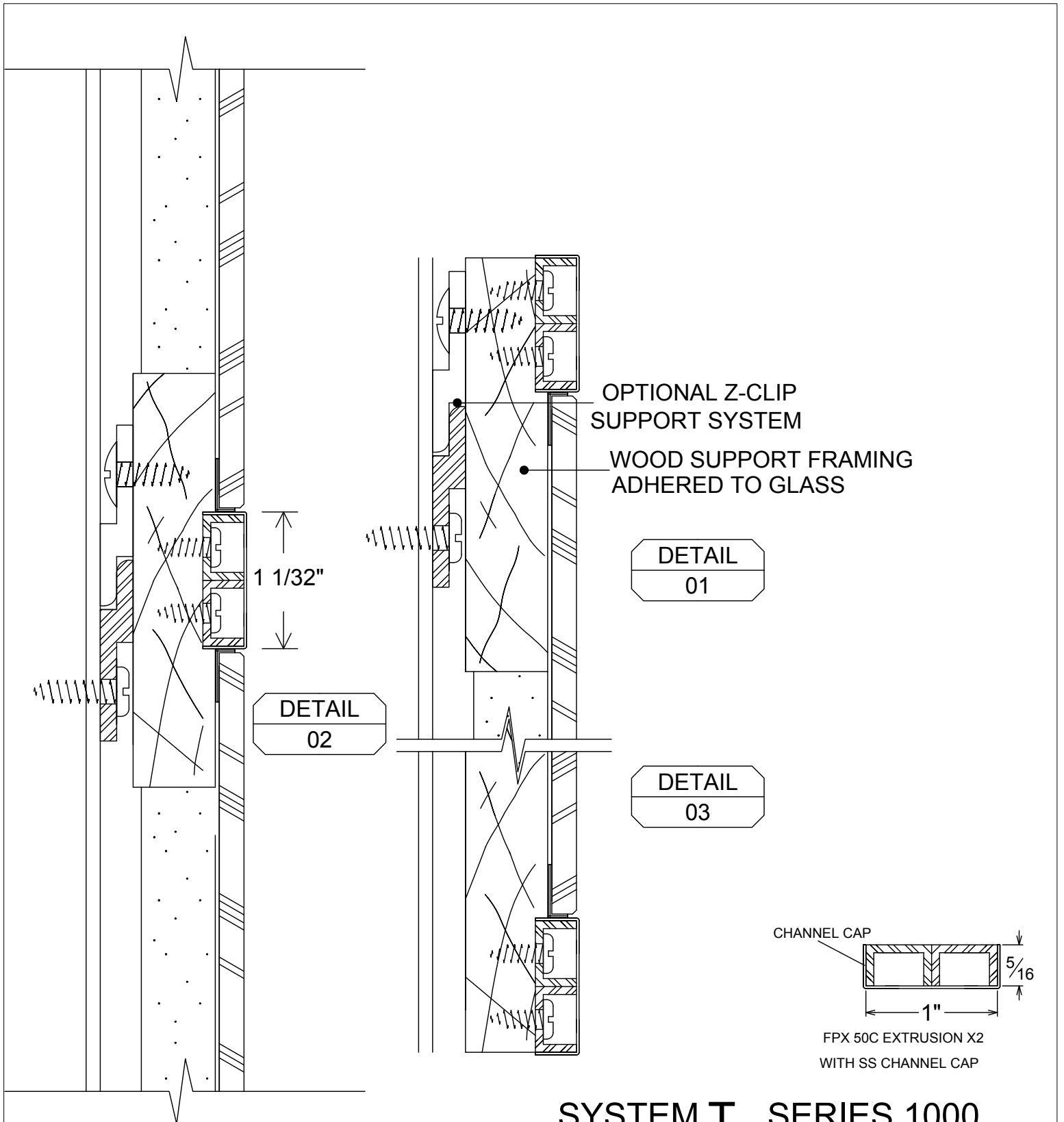

**SYSTEM I SERIES 1000
 FPX 1" - 1 1/32" PROFILE
 EXTRUSIONS FULL SIZE**

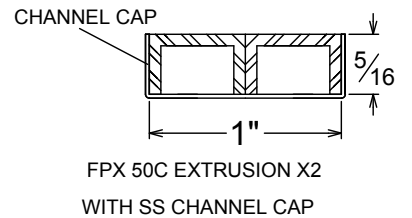
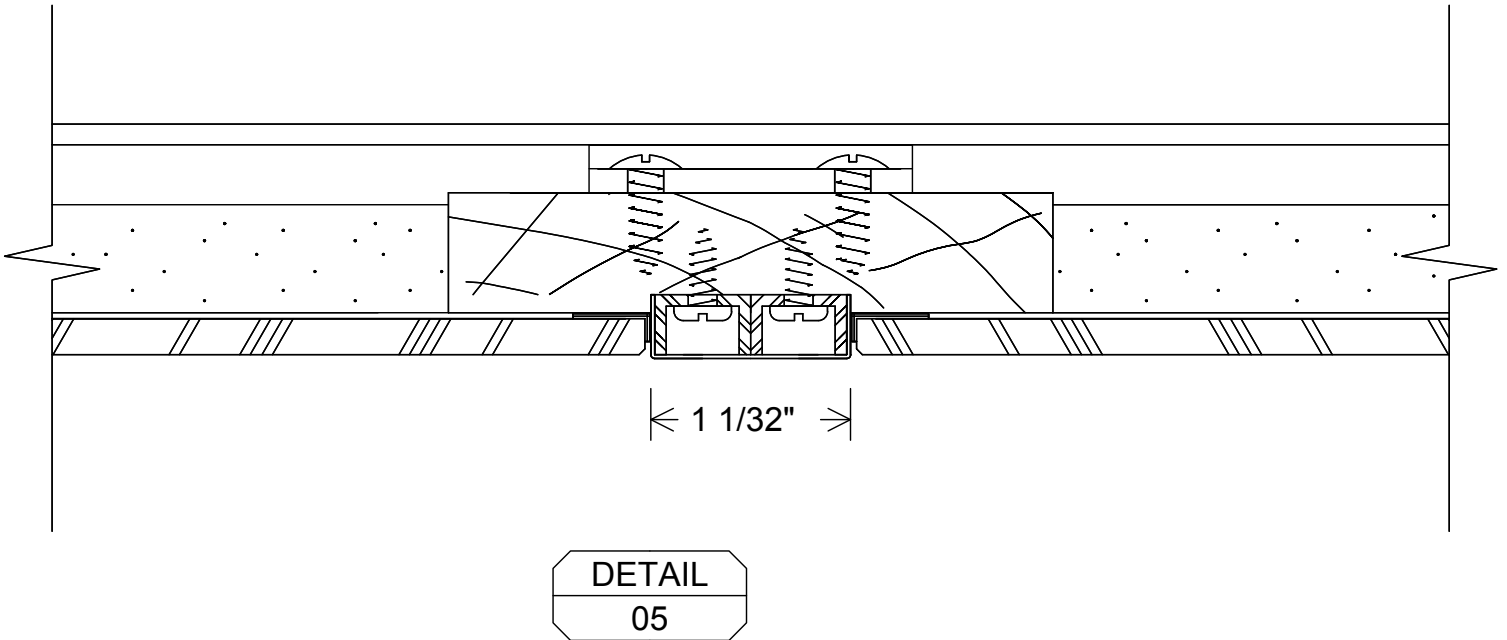
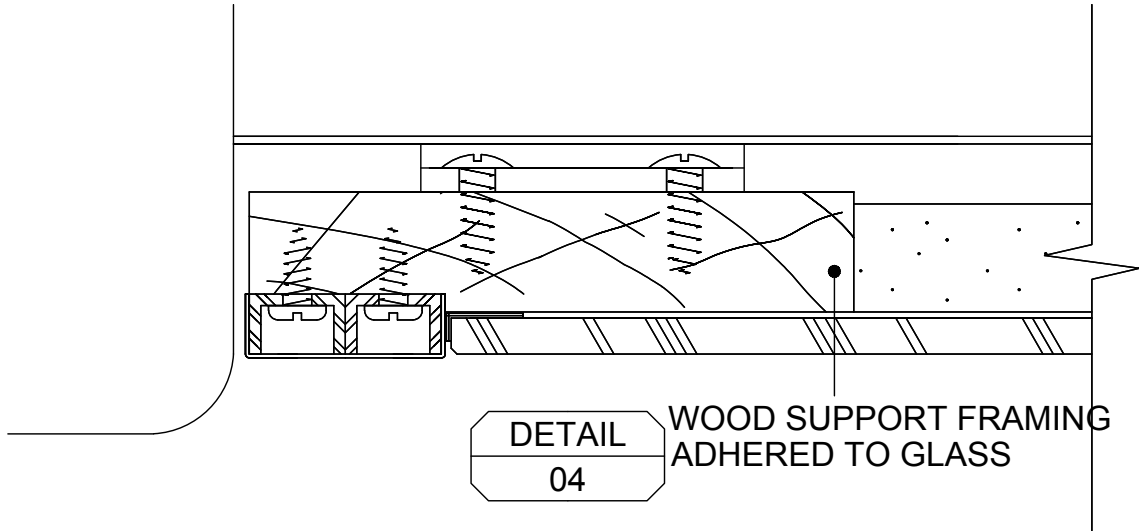

SYSTEM I SERIES 1000
FPX 1" - 1 1/32" PROFILE
EXTRUSIONS FULL SIZE

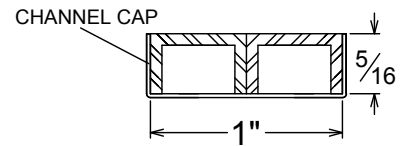
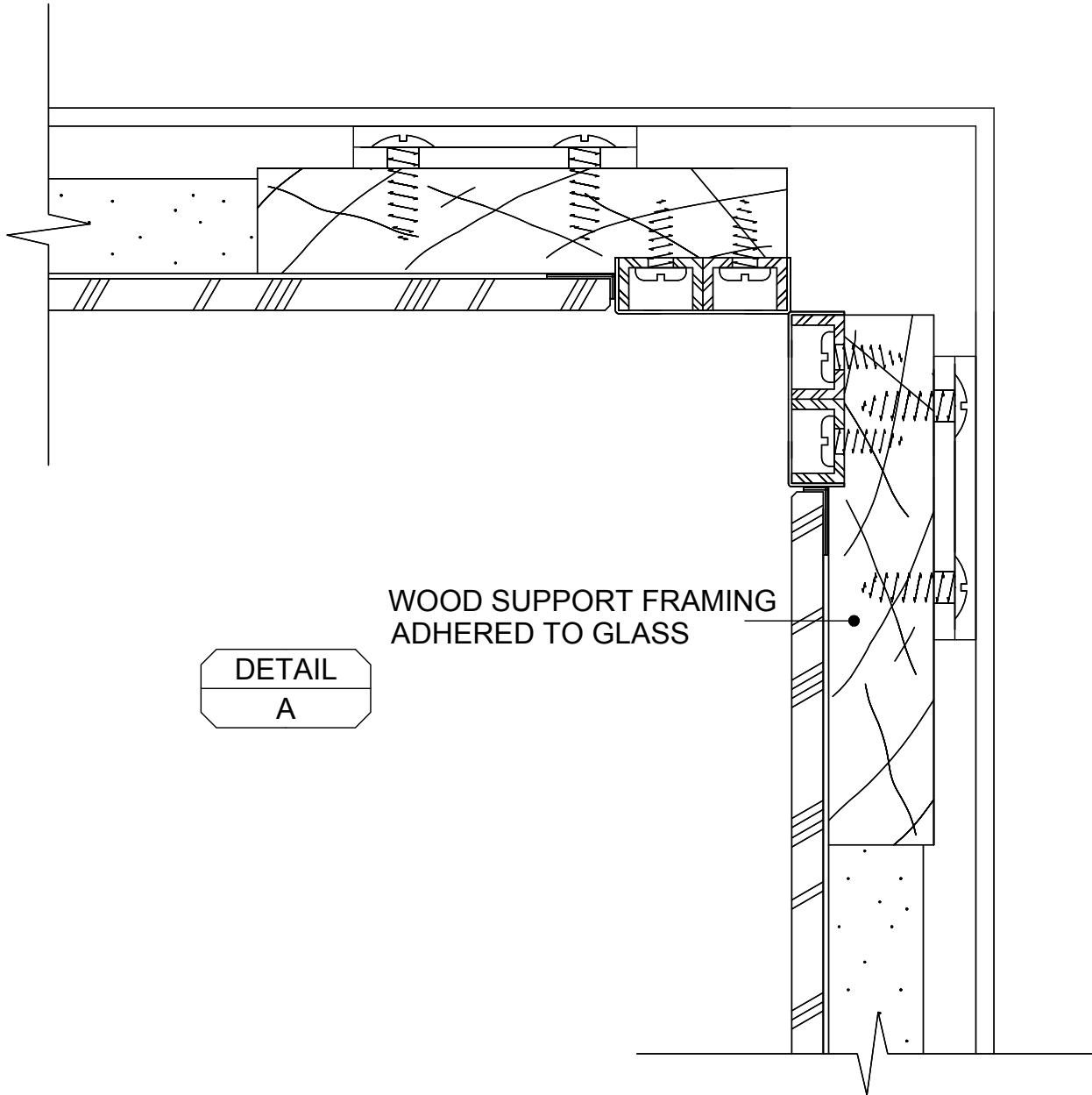

FPX 50C EXTRUSION X2
WITH SS CHANNEL CAP

SYSTEM I SERIES 1000
FPX 1" - 1 1/32" PROFILE
EXTRUSIONS FULL SIZE

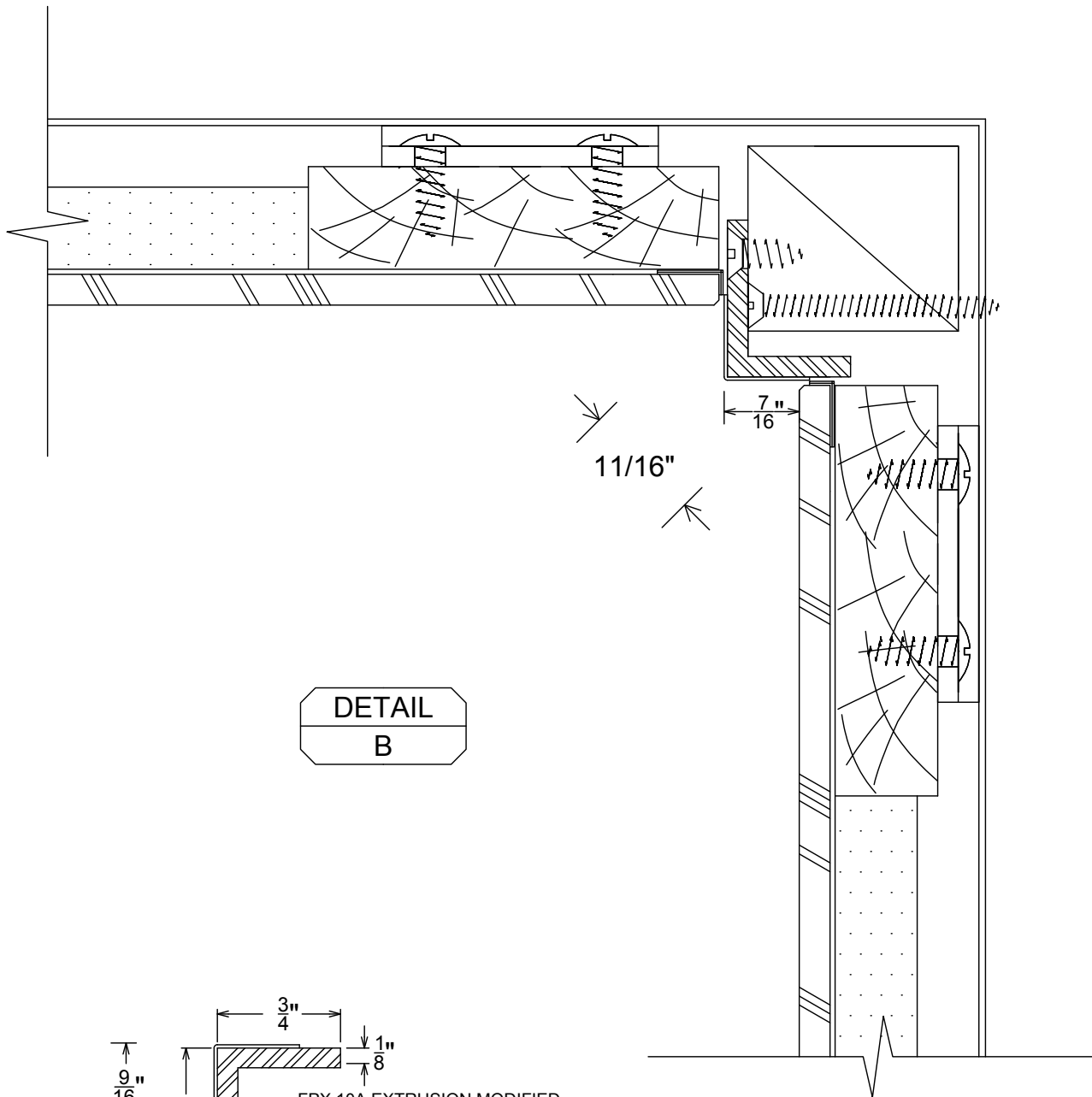

DETAIL
B

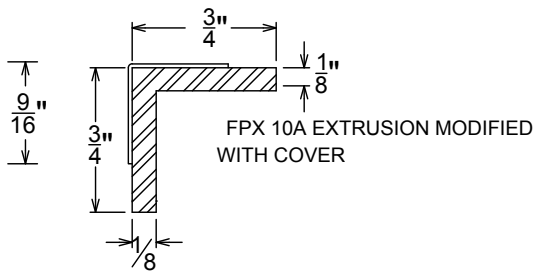

SYSTEM I SERIES 1000
FPX 1" - 1 1/32" PROFILE
EXTRUSIONS FULL SIZE

FOR MORE ABOUT FPX CEILINGS PLEASE
SEE OUR ELEVATOR CEILINGS SECTION

SUPPLIED ELEVATOR BOLTS INSTALLED
AT SPECIFIED LOCATIONS

SUPPORT SYSTEM
BY OTHERS

1/2" MIN. WITH Z-CLIPS

OPTIONAL Z-CLIP
SUPPORT SYSTEM
WOOD SUPPORT FRAMING
ADHERED TO GLASS

DETAIL
C

CHANNEL CAP
5/16
1"
FPX 50C EXTRUSION X2
WITH SS CHANNEL CAP

SYSTEM I SERIES 1000
FPX 1" - 1 1/32" PROFILE
EXTRUSIONS FULL SIZE

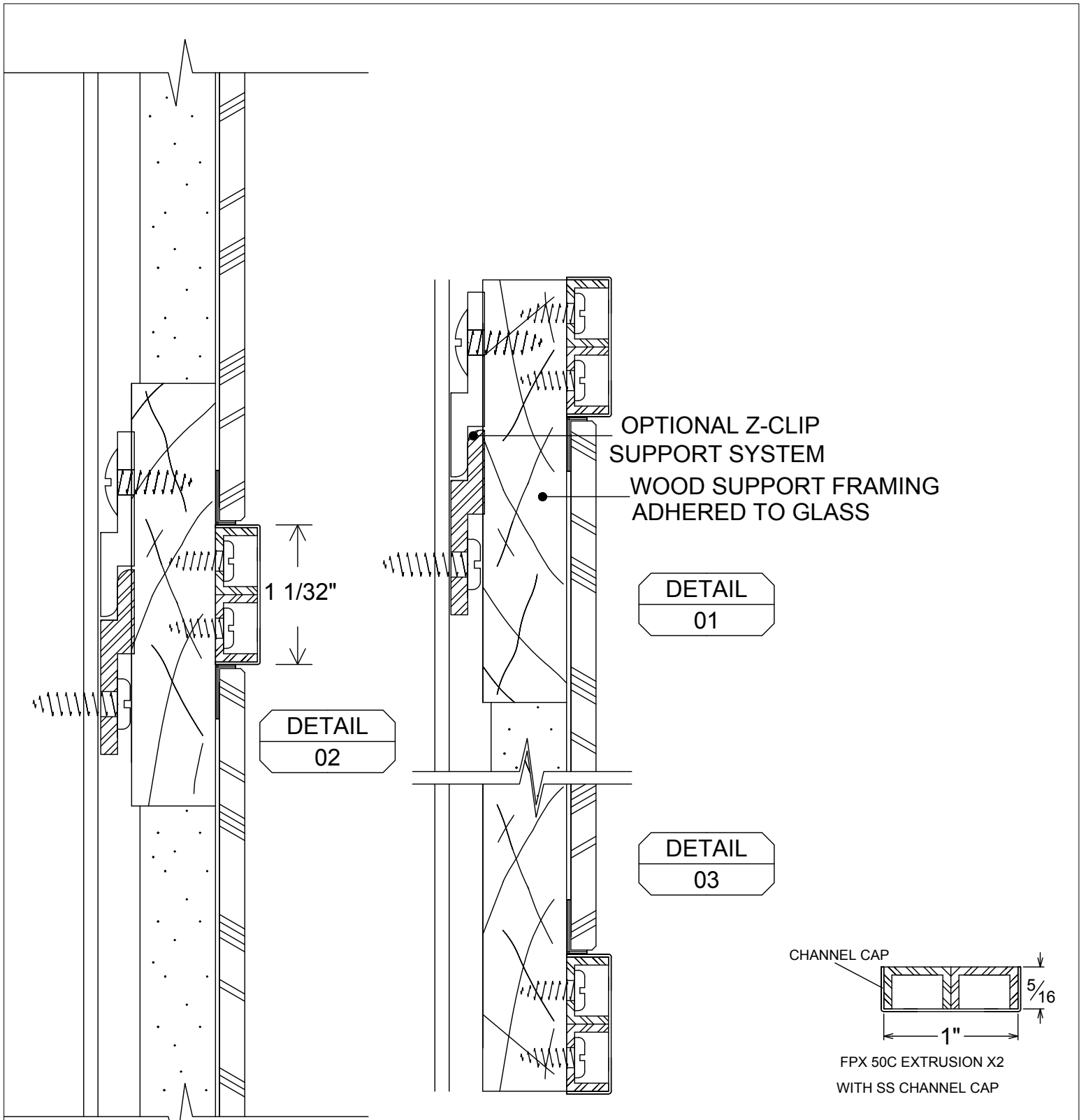

OPTIONAL Z-CLIP
SUPPORT SYSTEM
WOOD SUPPORT FRAMING
ADHERED TO GLASS

1 1/32"

DETAIL
02

DETAIL
01

DETAIL
03

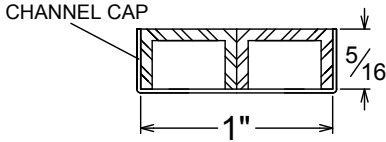

FPX 50C EXTRUSION X2
WITH SS CHANNEL CAP

**SYSTEM I SERIES 1000-EX
FPX 1" - 1 1/32" PROFILE
EXTRUSIONS FULL SIZE**

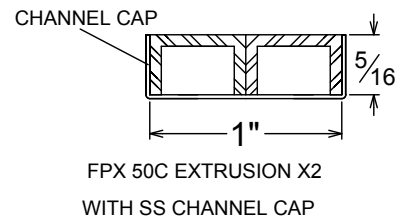
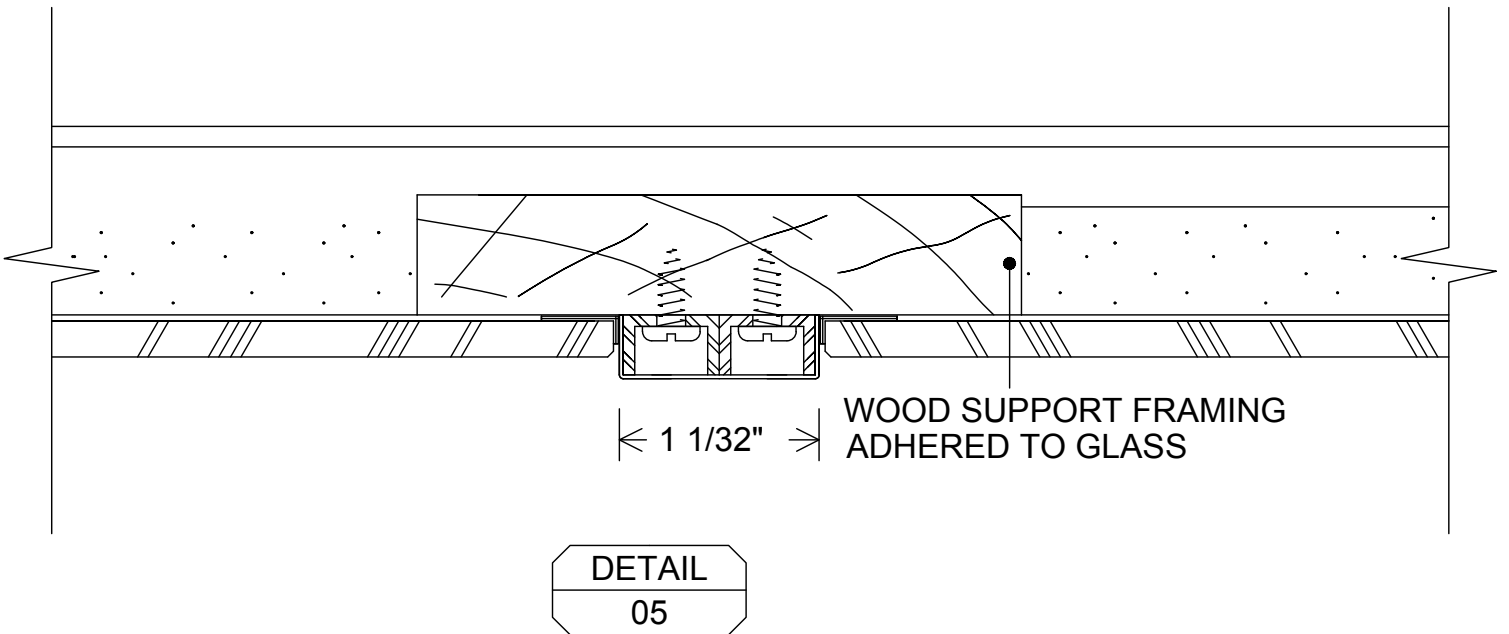
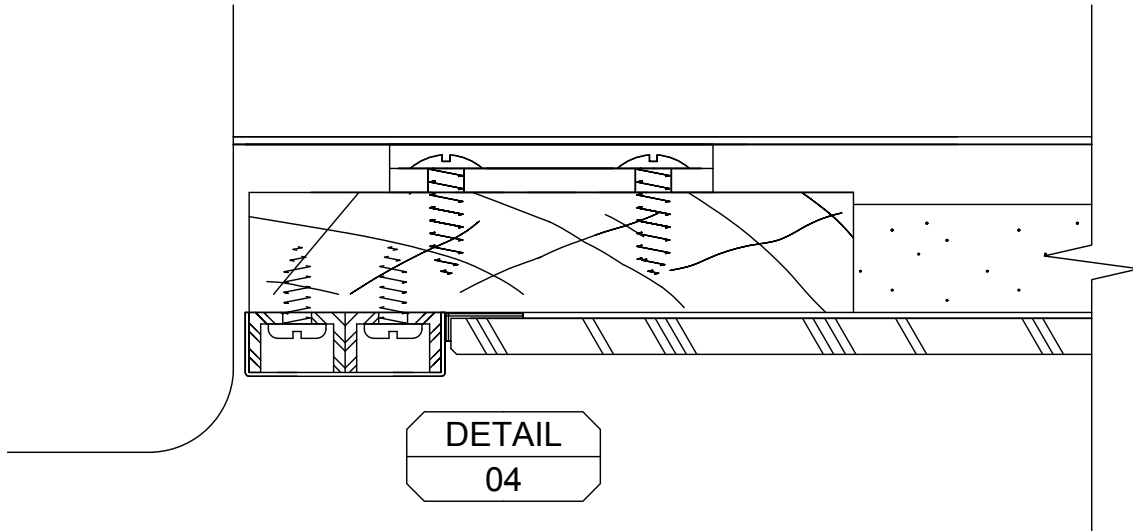

SYSTEM I SERIES 1000-EX
FPX 1" - 1 1/32" PROFILE
EXTRUSIONS FULL SIZE

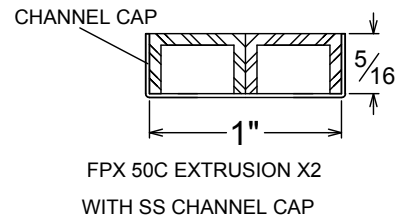
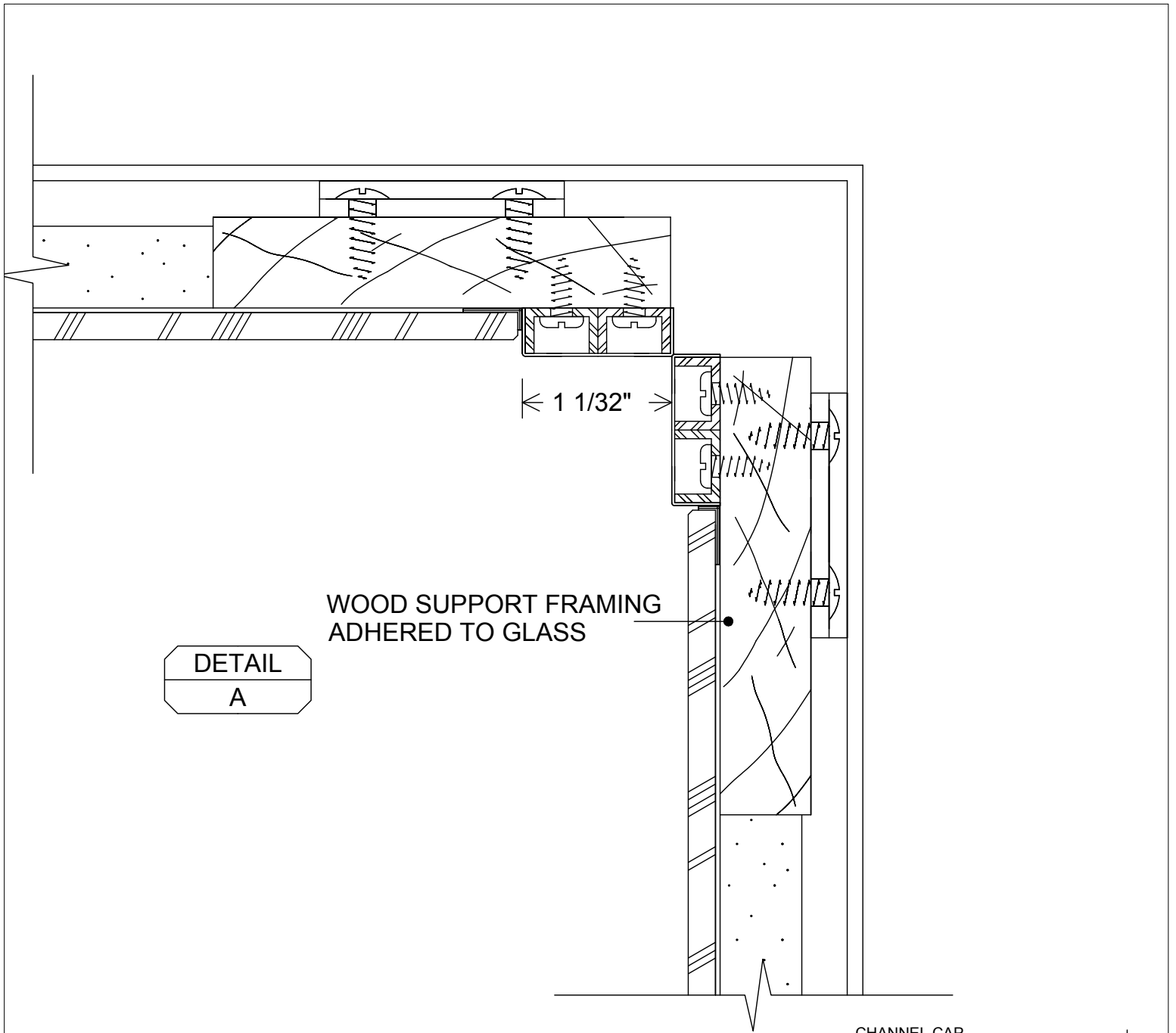

SYSTEM I SERIES 1000-EX
FPX 1" - 1 1/32" PROFILE
EXTRUSIONS FULL SIZE

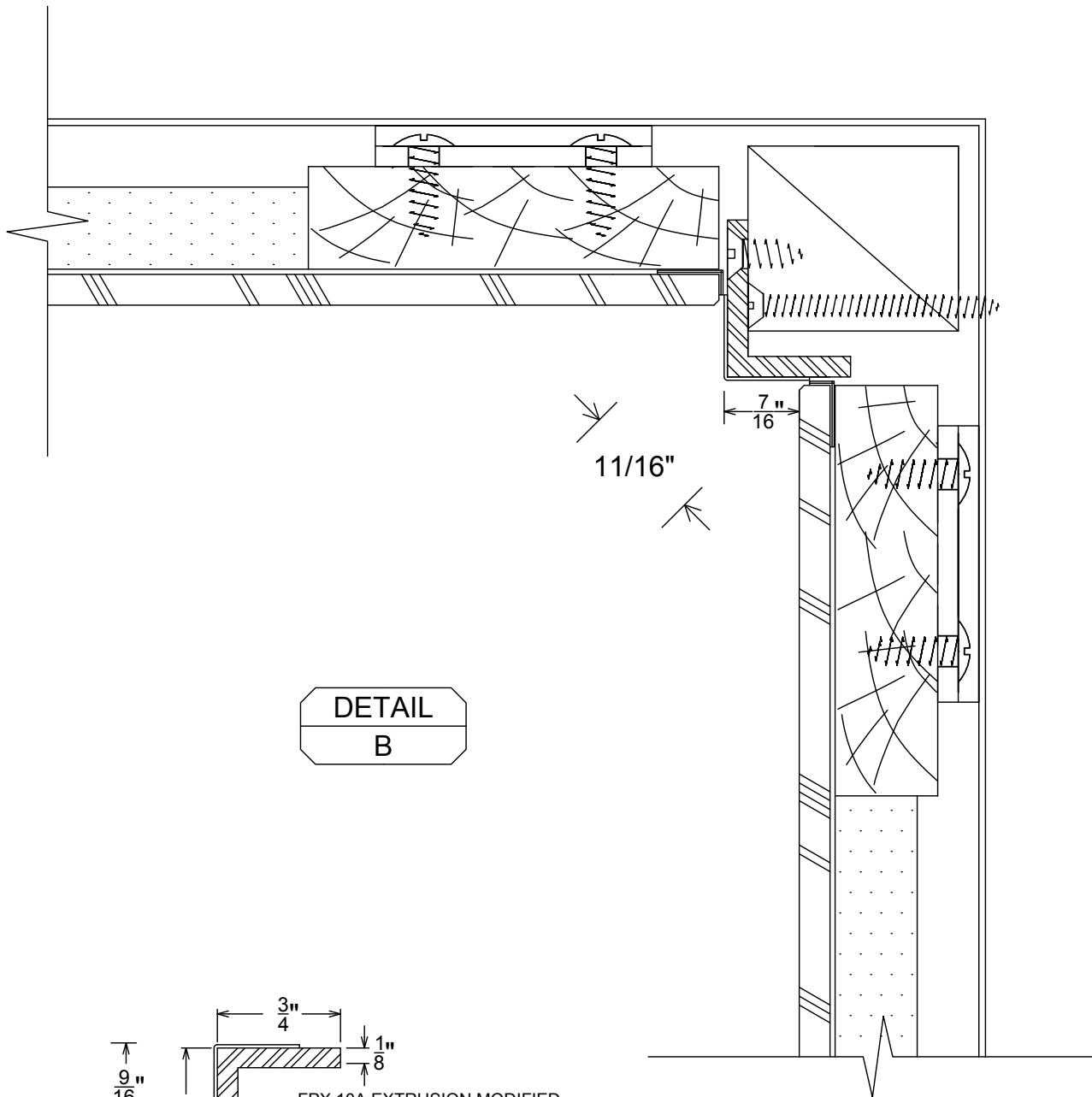

DETAIL
B

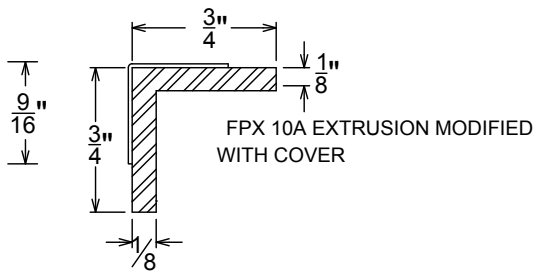

SYSTEM I SERIES 1000-EX
FPX 1" - 1 1/32" PROFILE
EXTRUSIONS FULL SIZE

FOR MORE ABOUT FPX CEILINGS PLEASE
SEE OUR ELEVATOR CEILINGS SECTION

SUPPLIED ELEVATOR BOLTS INSTALLED
AT SPECIFIED LOCATIONS

SUPPORT SYSTEM
BY OTHERS

1/2" MIN. WITH Z-CLIPS

OPTIONAL Z-CLIP
SUPPORT SYSTEM
WOOD SUPPORT FRAMING
ADHERED TO GLASS

DETAIL
C

CHANNEL CAP
5/16
1"
FPX 50C EXTRUSION X2
WITH SS CHANNEL CAP

SYSTEM I SERIES 1000-EX
FPX 1" - 1 1/32" PROFILE
EXTRUSIONS FULL SIZE