

NOT TO SCALE

FINISHES:

ST. STL. - #4 SATIN, or BRITE
SPECIAL - CONTACT FACTORY

SYSTEM II
SERIES-500
FLUSH

FULLER PHOENIX ARCHITECTURAL PRODUCTS

713.699.2262

www.fullerphoenix.com

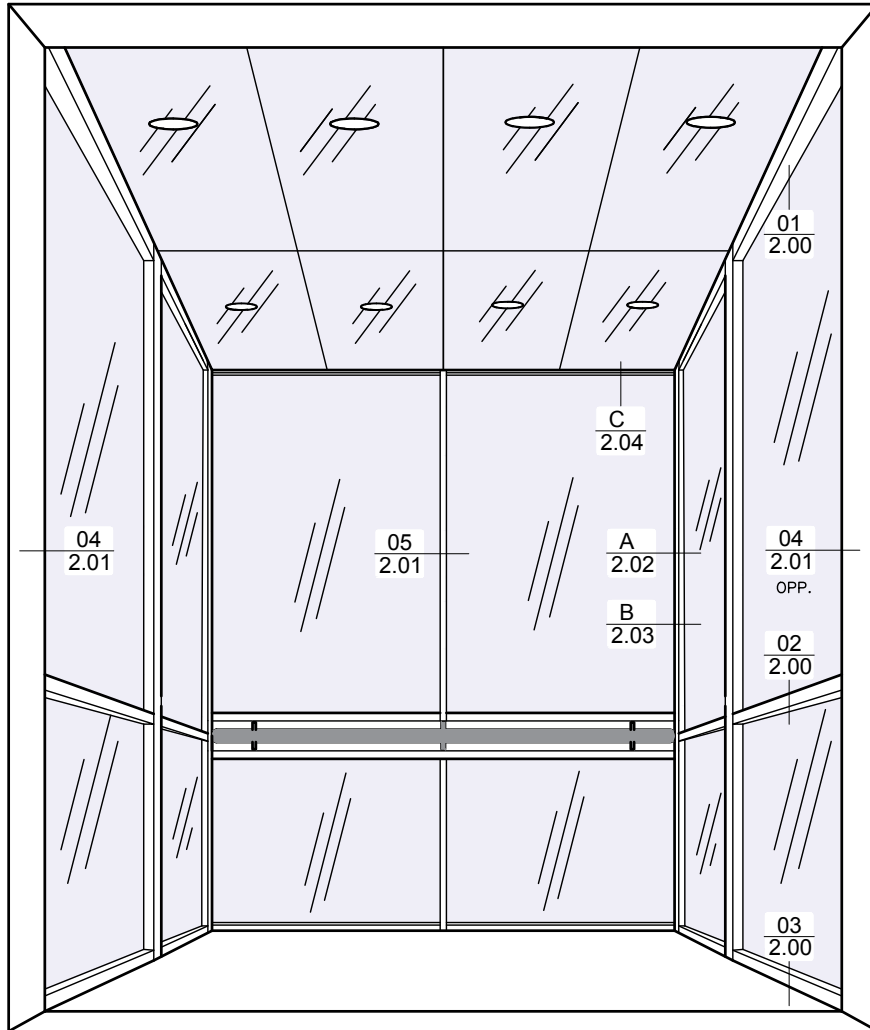

NOT TO SCALE

FINISHES:

ST. STL. - #4 SATIN, or BRITE
SPECIAL - CONTACT FACTORY

SYSTEM II
SERIES-500 EX
EXTENDED

FULLER PHOENIX ARCHITECTURAL PRODUCTS

713.699.2262

www.fullerphoenix.com

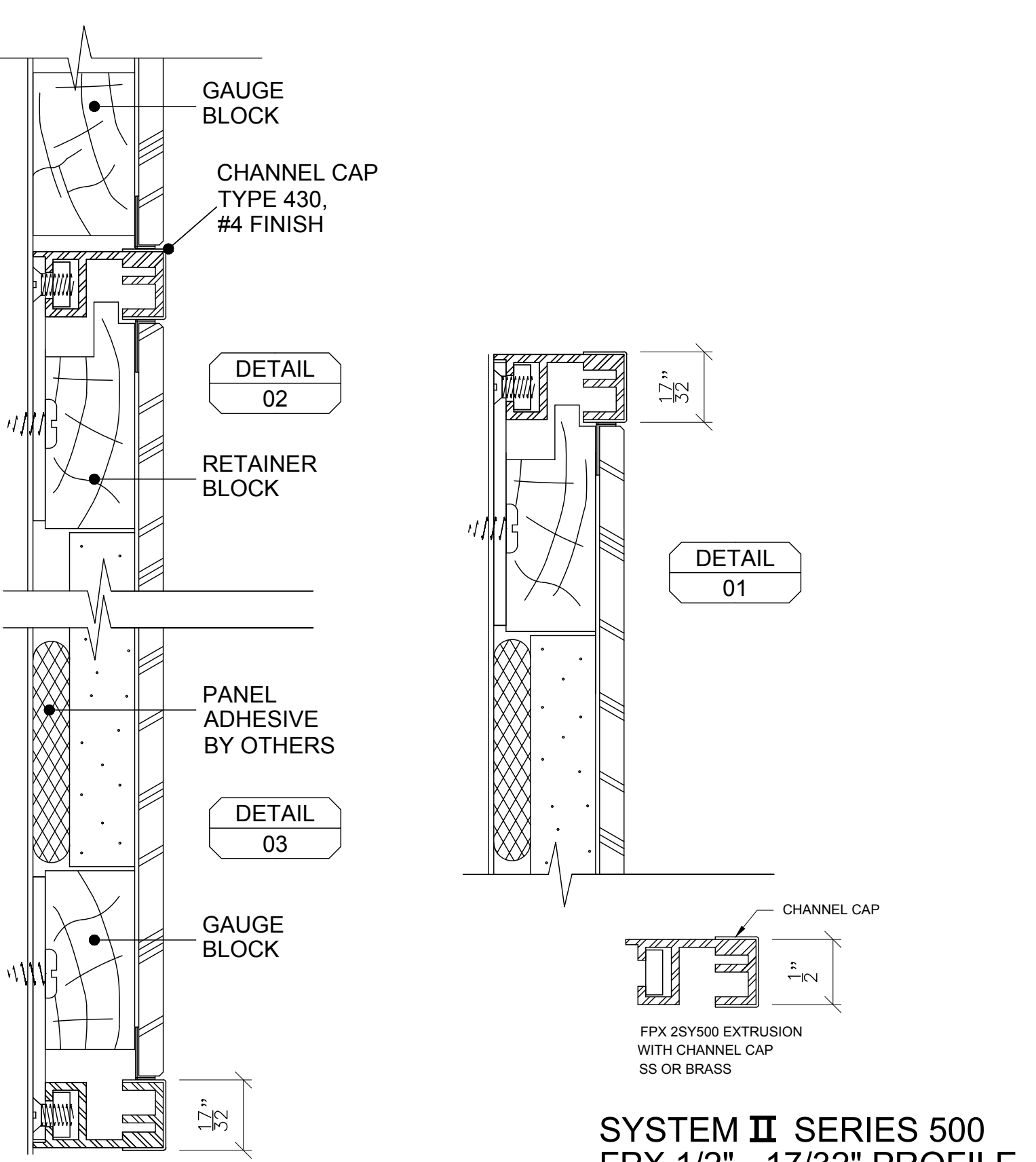

**SYSTEM II SERIES 500
FPX 1/2" - 17/32" PROFILE
EXTRUSIONS FULL SIZE**

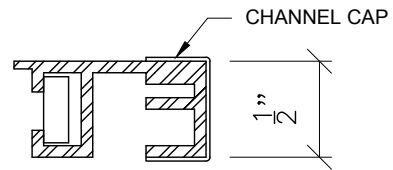
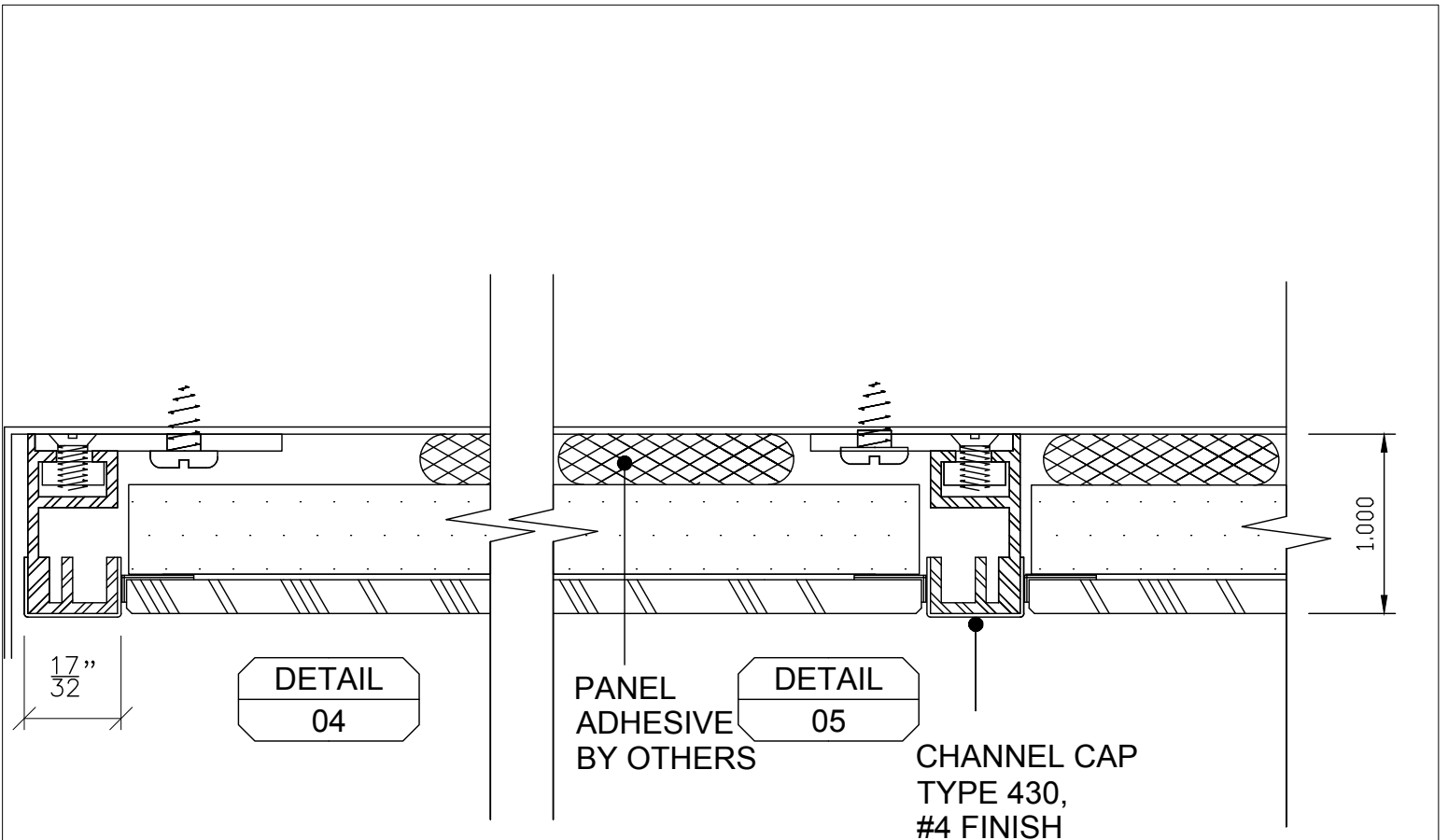

FPX 2SY500 EXTRUSION
WITH CHANNEL CAP
SS OR BRASS

SYSTEM II SERIES 500
FPX 1/2" - 17/32" PROFILE
EXTRUSIONS FULL SIZE

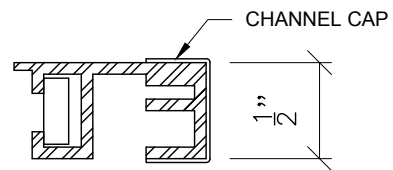
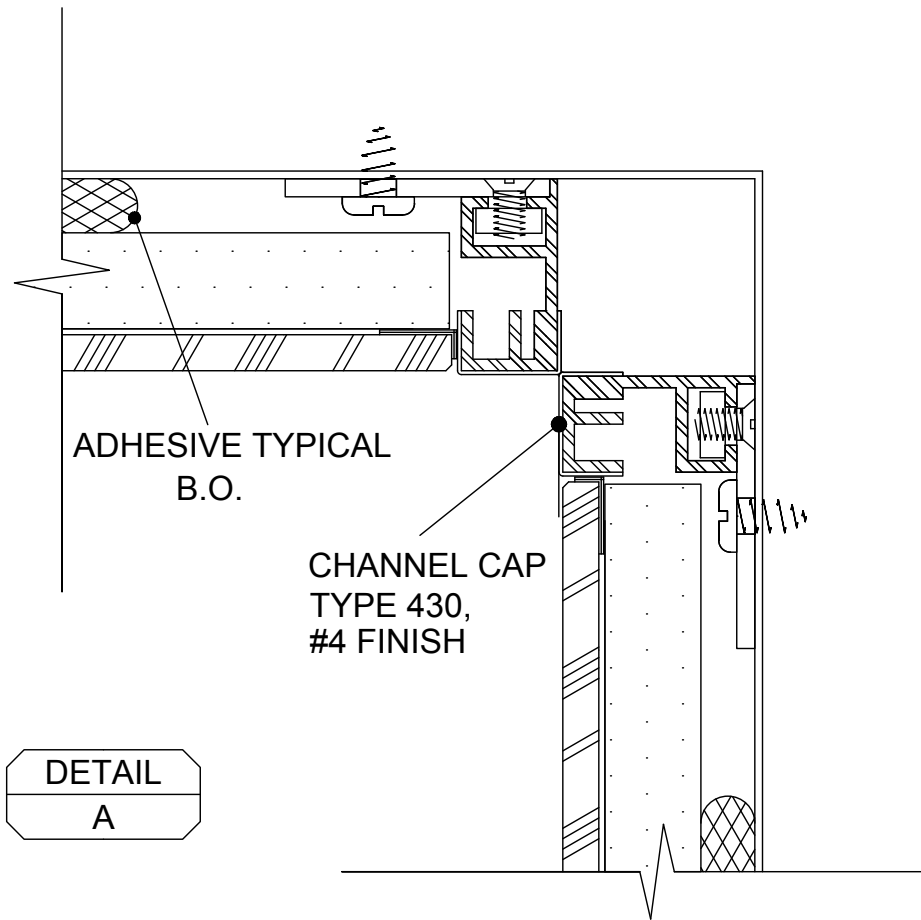

FPX 2SY500 EXTRUSION
WITH CHANNEL CAP
SS OR BRASS

SYSTEM II SERIES 500
FPX 1/2" - 17/32" PROFILE
EXTRUSIONS FULL SIZE

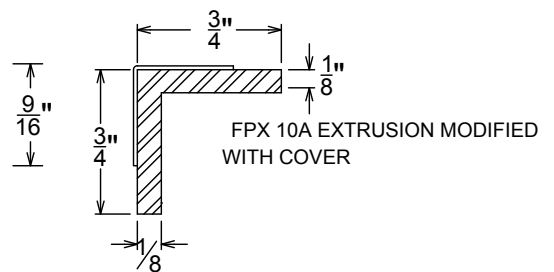
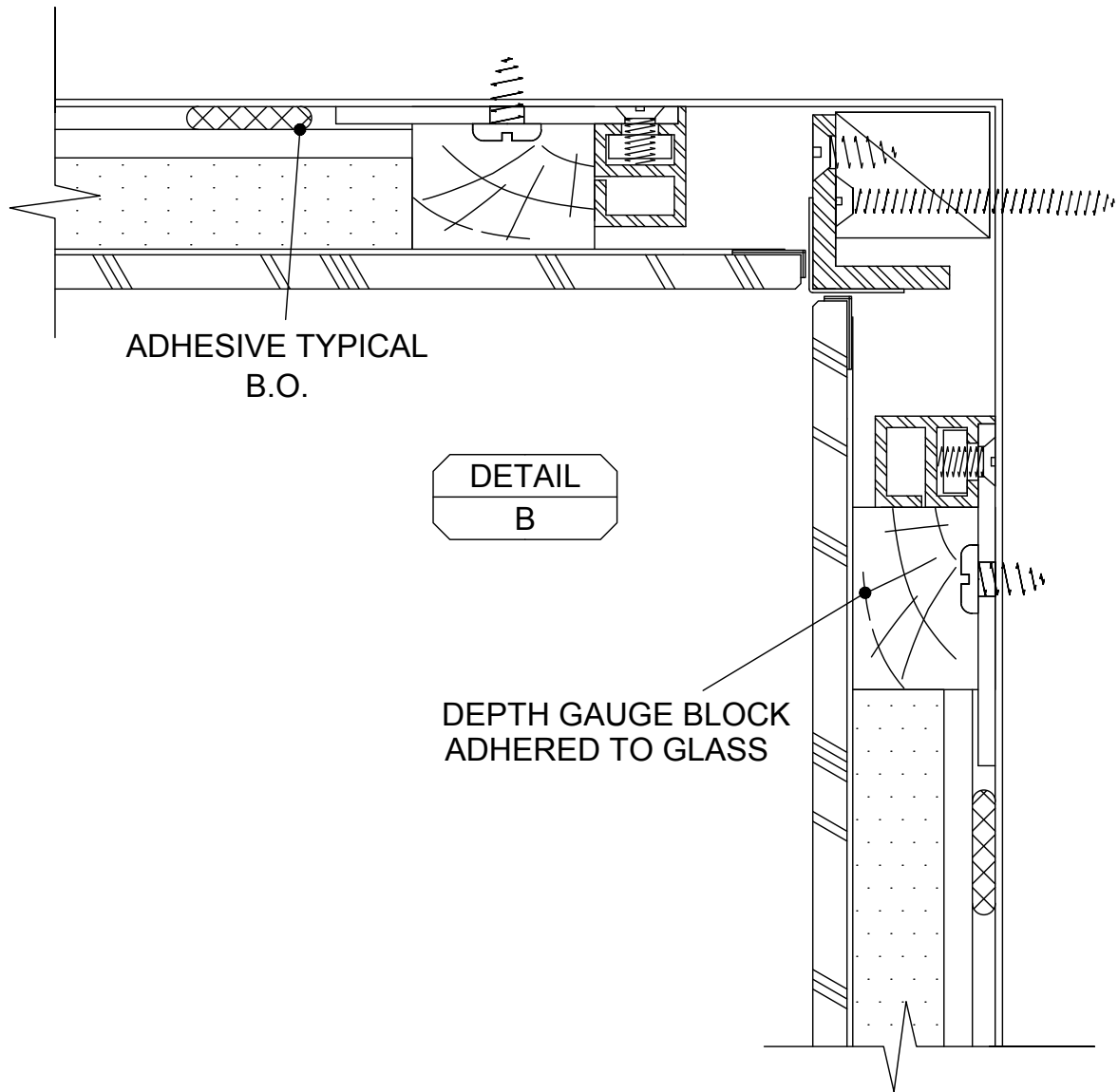

**SYSTEM II SERIES 500
 FPX 1/2" - 17/32" PROFILE
 EXTRUSIONS FULL SIZE**

FOR MORE ABOUT FPX CEILINGS PLEASE
SEE OUR ELEVATOR CEILINGS SECTION

SUPPLIED ELEVATOR BOLTS INSTALLED
AT SPECIFIED LOCATIONS

SUPPORT SYSTEM
BY OTHERS

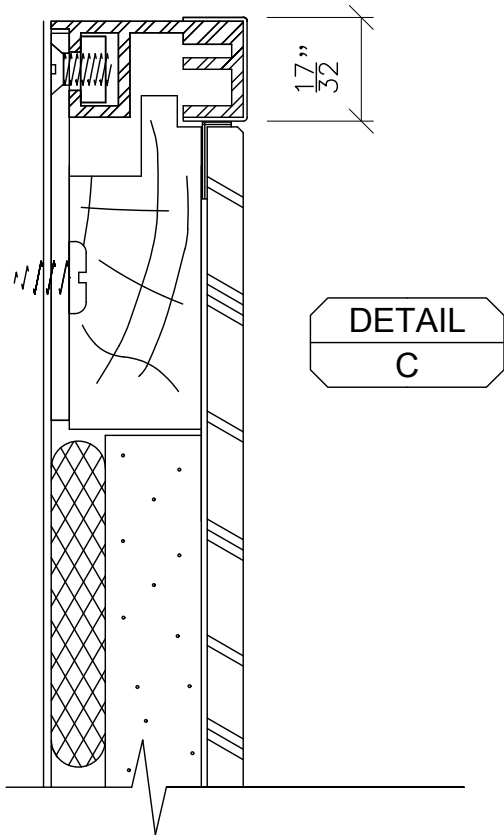
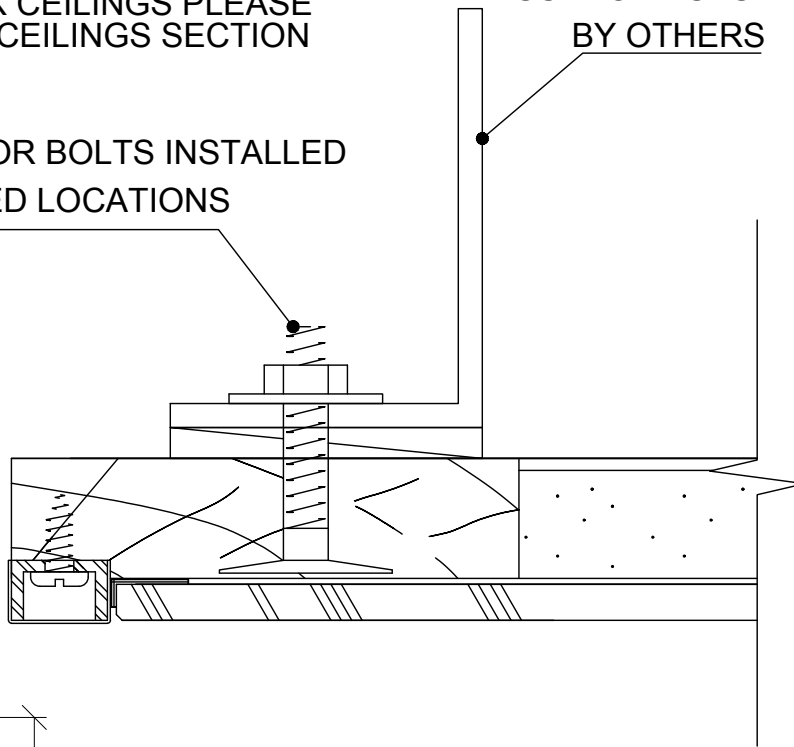

SYSTEM II SERIES 500
FPX 1/2" - 17/32" PROFILE
EXTRUSIONS FULL SIZE

CHANNEL CAP
SHOWN 1/8" PROUD
TYPE 430,
#4 FINISH

1/8"

CHANNEL CAP
ADJUSTABLE FROM
FLUSH TO 1/8" PROUD

DETAIL
02

RETAINER
BLOCK

PANEL
ADHESIVE
BY OTHERS

GAUGE
BLOCK

DETAIL
03

17"
32

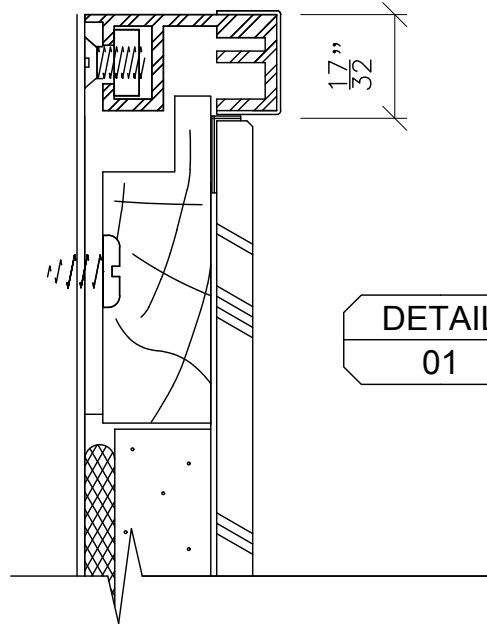

DETAIL
01

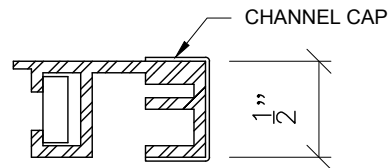

FPX 2SY500 EXTRUSION
WITH CHANNEL CAP
SS OR BRASS

SYSTEM II SERIES 500-EX FPX 1/2" - 17/32" PROFILE EXTRUSIONS FULL SIZE

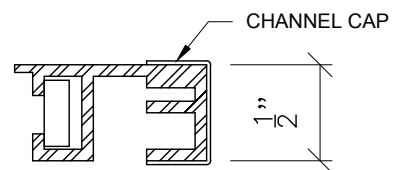
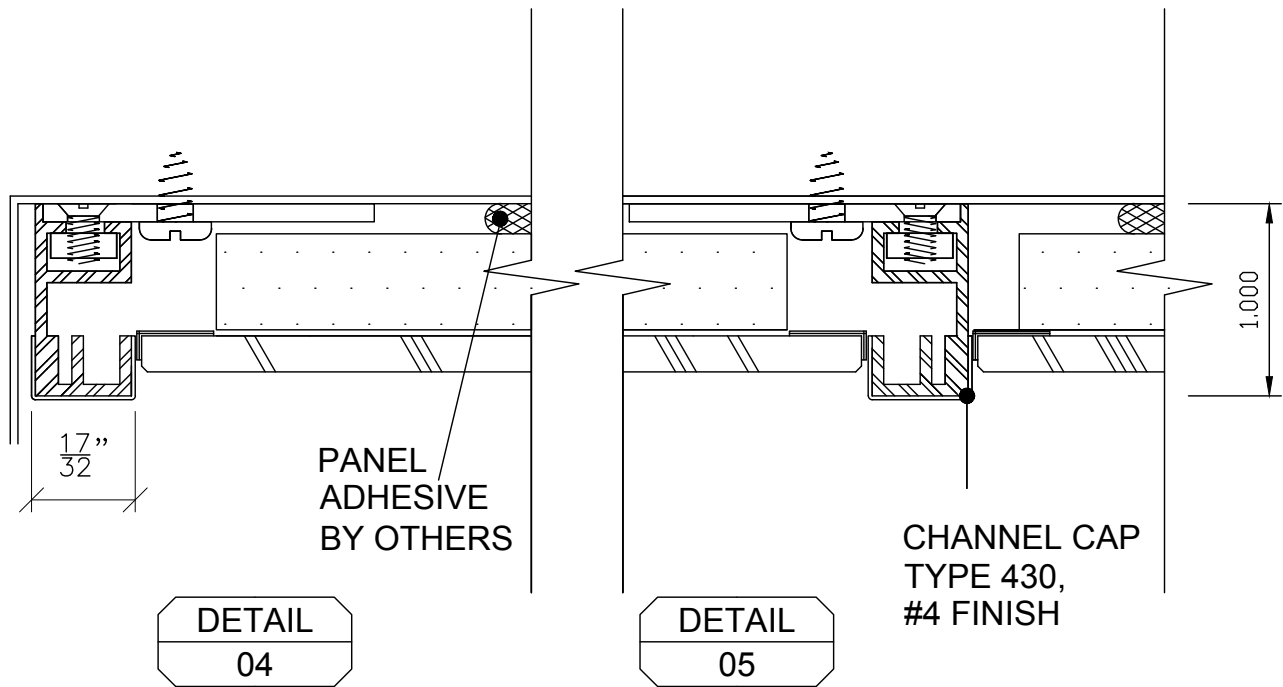

FPX 2SY500 EXTRUSION
WITH CHANNEL CAP
SS OR BRASS

SYSTEM II SERIES 500-EX
FPX 1/2" - 17/32" PROFILE
EXTRUSIONS FULL SIZE

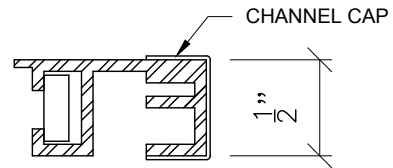
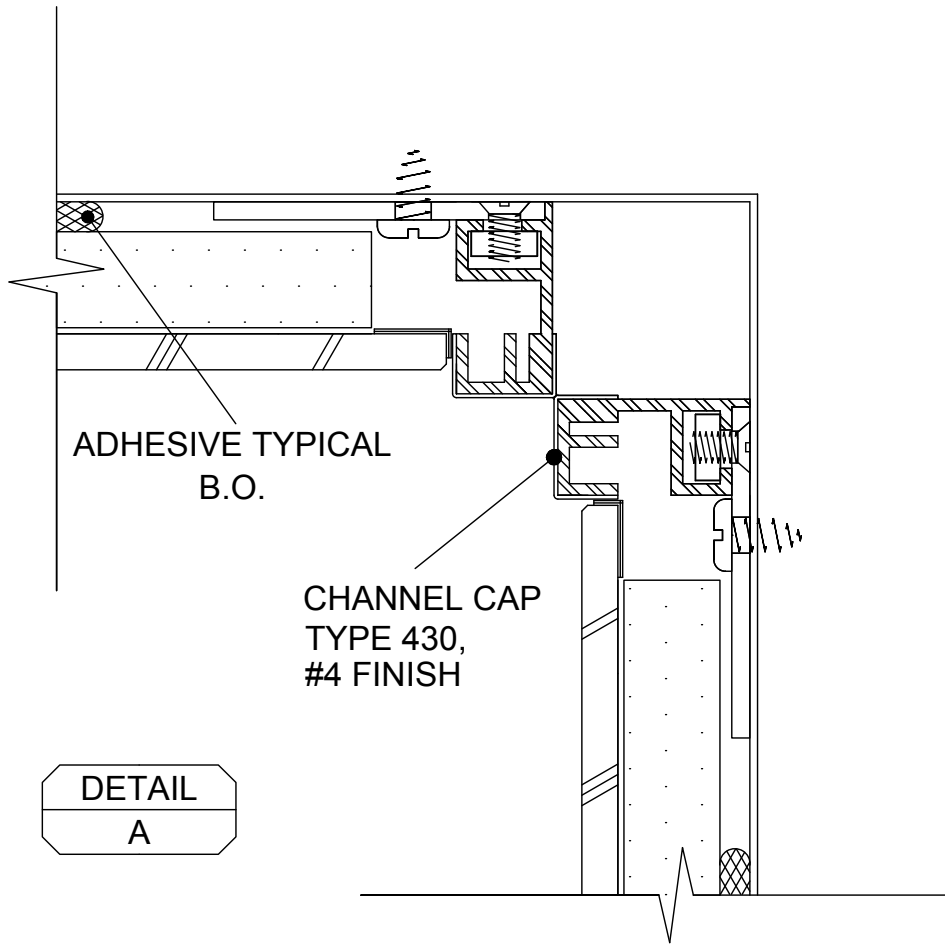

FPX 2SY500 EXTRUSION
WITH CHANNEL CAP
SS OR BRASS

SYSTEM II SERIES 500-EX
FPX 1/2" - 17/32" PROFILE
EXTRUSIONS FULL SIZE

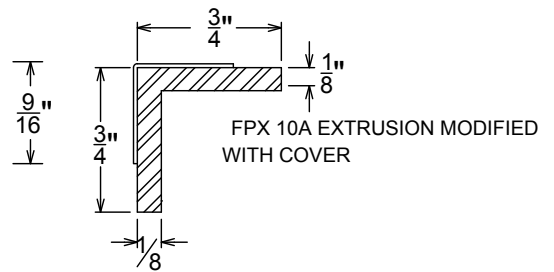
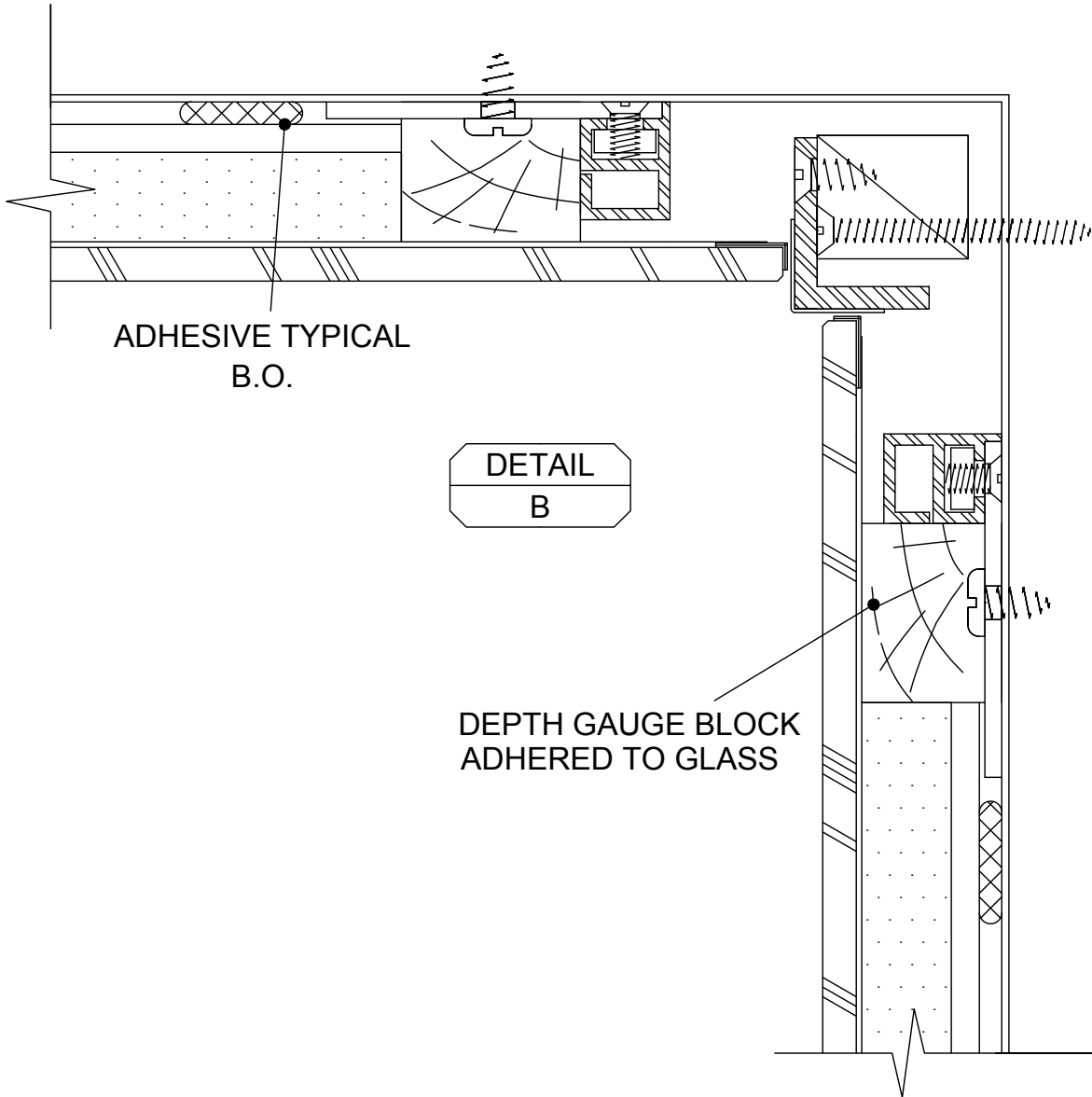

**SYSTEM II SERIES 500-EX
FPX 1/2" - 17/32" PROFILE
EXTRUSIONS FULL SIZE**

FOR MORE ABOUT FPX CEILINGS PLEASE
SEE OUR ELEVATOR CEILINGS SECTION

SUPPLIED ELEVATOR BOLTS INSTALLED
AT SPECIFIED LOCATIONS

SUPPORT SYSTEM
BY OTHERS

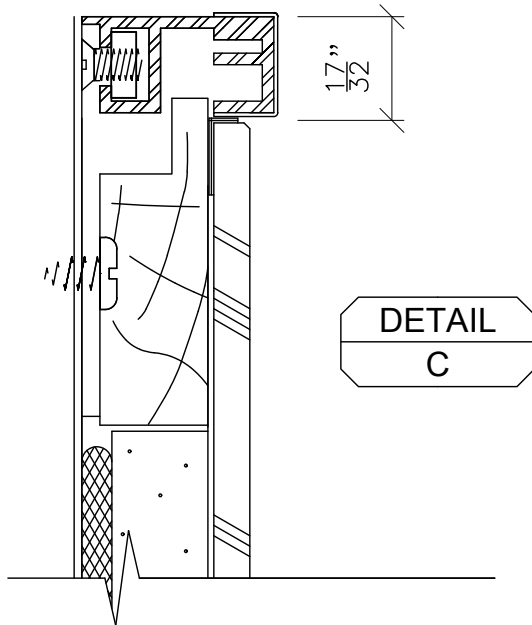
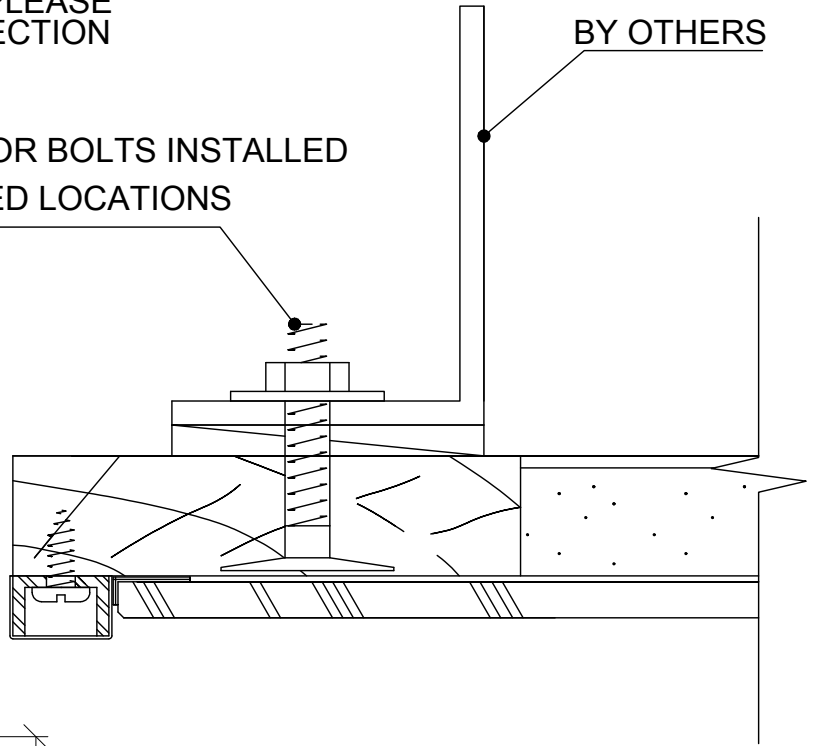

SYSTEM II SERIES 500-EX
FPX 1/2" - 17/32" PROFILE
EXTRUSIONS FULL SIZE