

Trim Length: - Per customers specification
Weight per lineal ft.: - Careo 7011 = 0.84 lbs

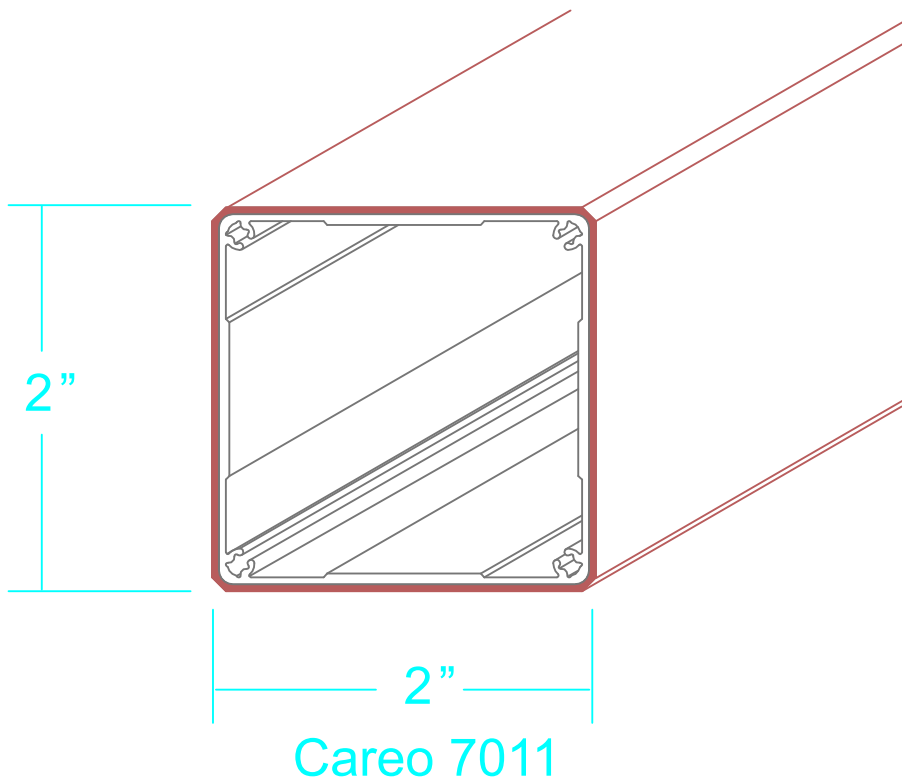

Geolam
Architectural Eco-Technology

Title **Hybrid Aluminum/WPC**
Careo 7011

Drawn **RP** Revision

Date **3/4/19** Date