

Trim Length: - Per customers specification
Weight per lineal ft.: - Careo 7015 = 0.47 lbs

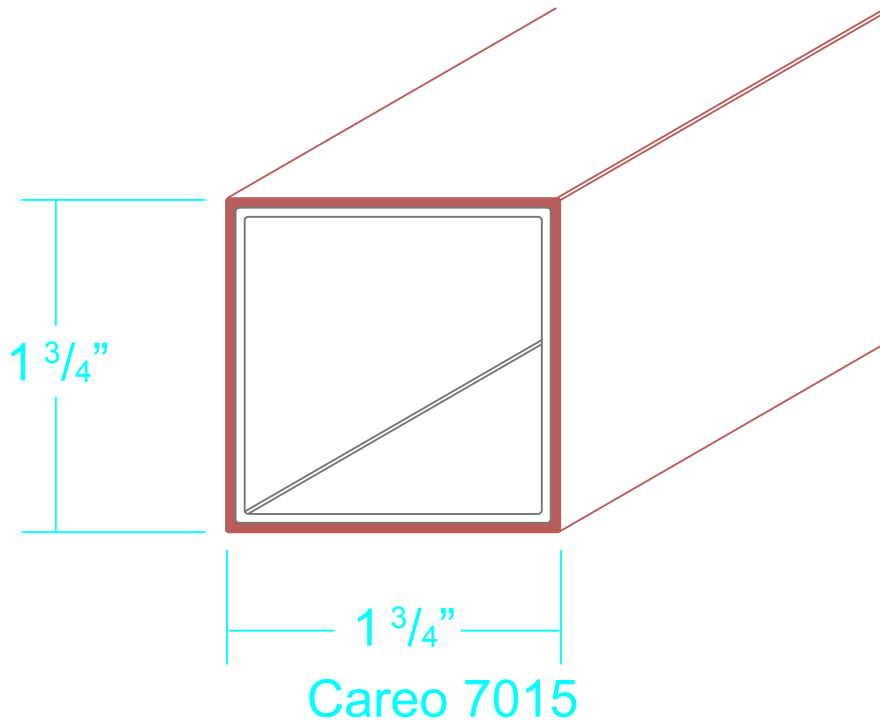

Geolam
Architectural Eco-Technology

Title **Hybrid Aluminum/WPC**
Careo 7015

Drawn **RP** Revision

Date **2/08/19** Date