

Trim Length: - Per customers specification
Weight per lineal ft.: - Careo 7016 = 2.69 lbs

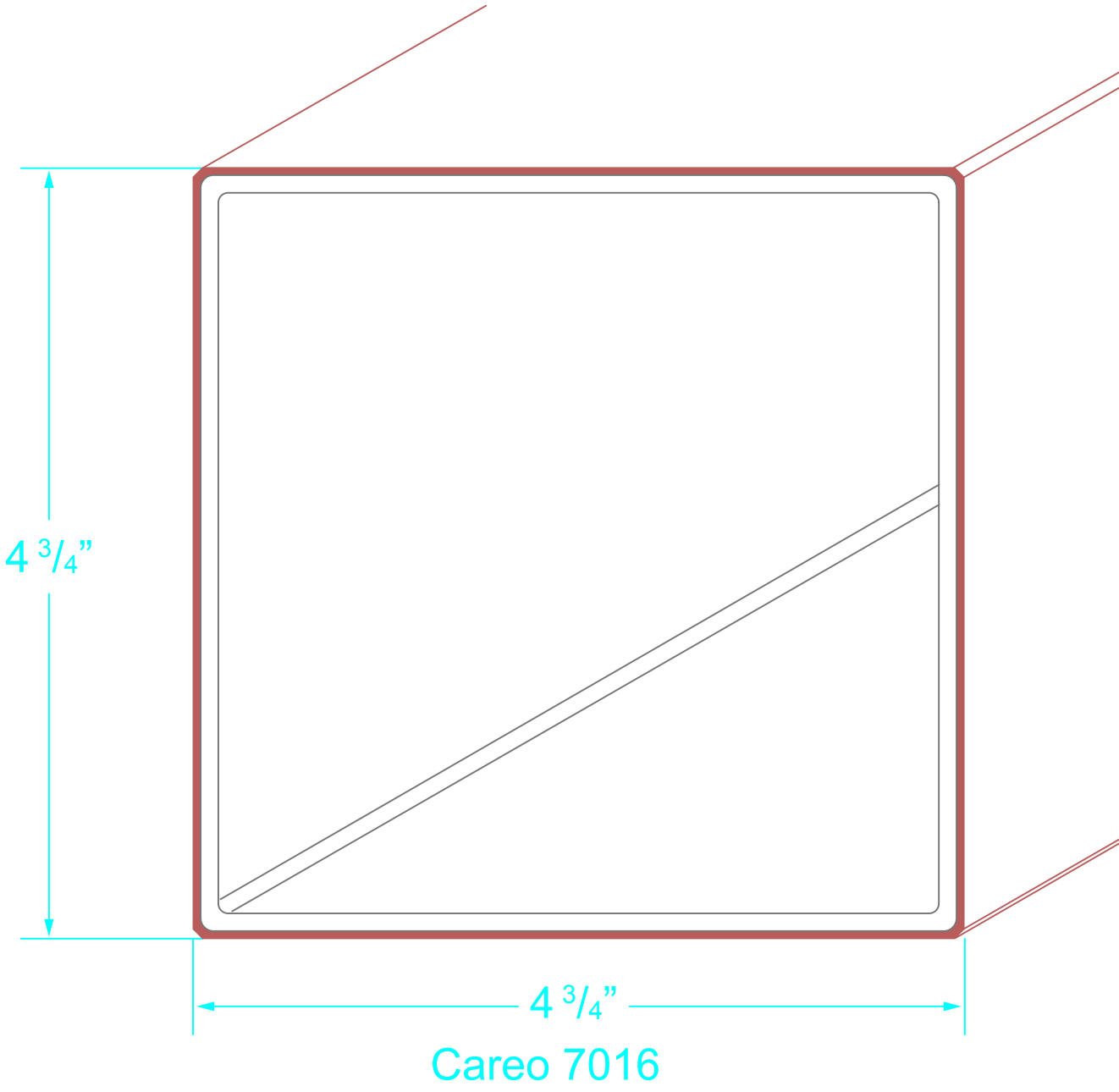

Geolam
Architectural Eco-Technology

Title
Hybrid Aluminum/WPC
Careo 7016

Drawn RP Revision

Date 3/4/19 Date