

Trim Length: - Per customers specification
Weight per lineal ft.: - Soleo 6029 = 0.67 lbs

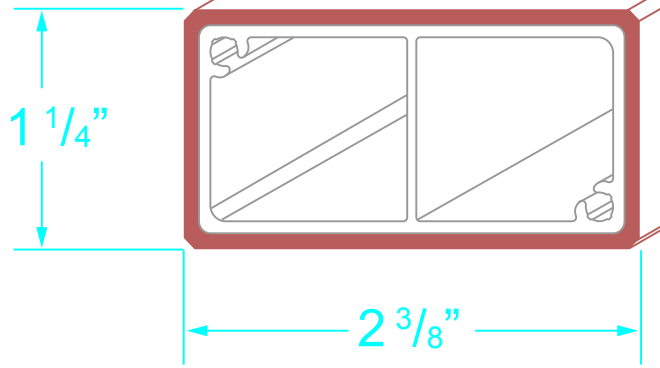

Soleo 6029

Geolam
Architectural Eco-Technology

Title
**Hybrid Aluminum/WPC
Soleo 6029**

Drawn **RP** Revision

Date **3/4/19** Date