

Trim Length: - Per customers specification
Weight per lineal ft.: - Soleo 6030 = 0.80 lbs

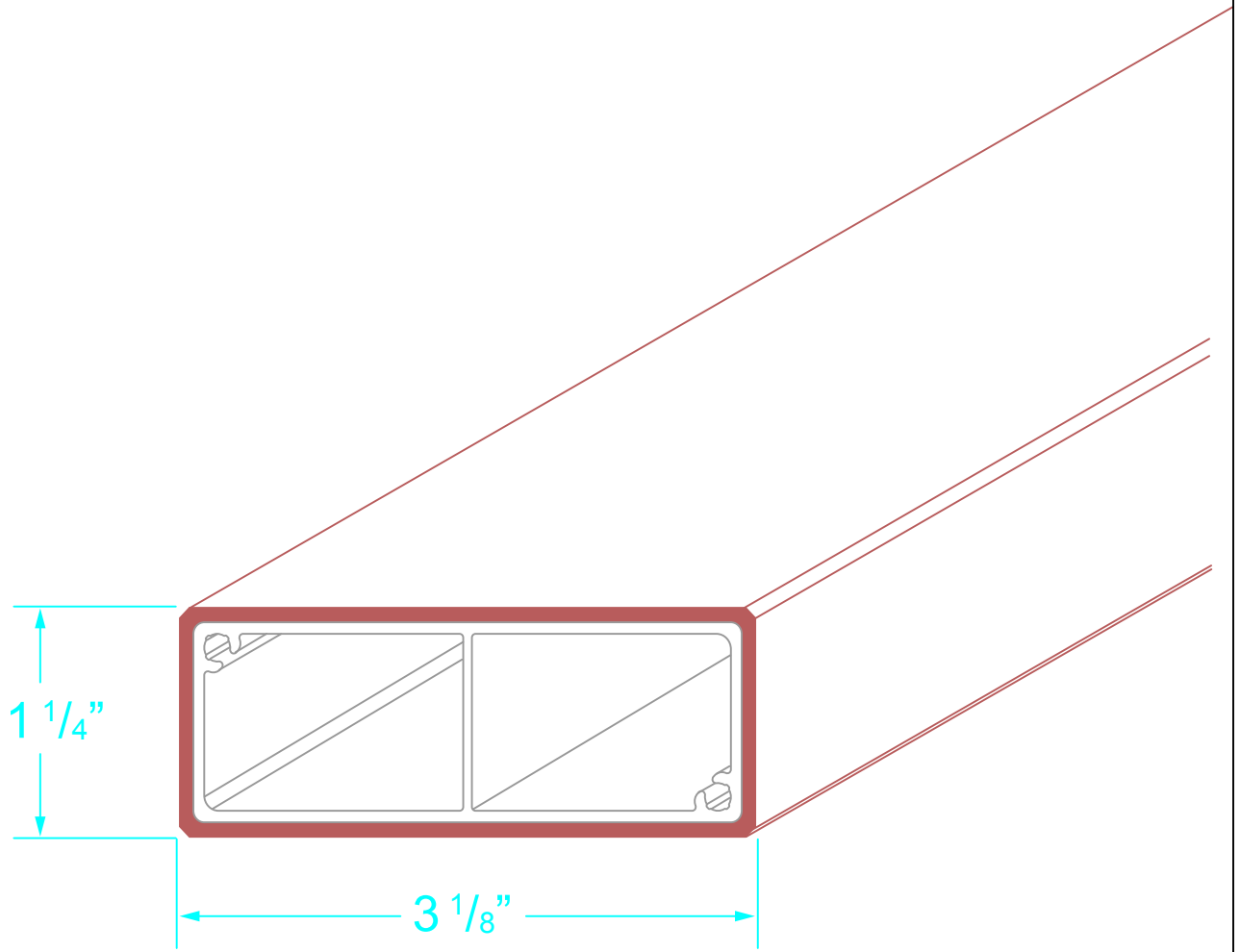

Soleo 6030

Geolam
Architectural Eco-Technology

Title
**Hybrid Aluminum/WPC
Soleo 6030**

Drawn **RP** Revision

Date **3/4/19** Date