

Trim Length: - Per customers specification
Weight per lineal ft.: - Soleo 6031 = 1.16 lbs

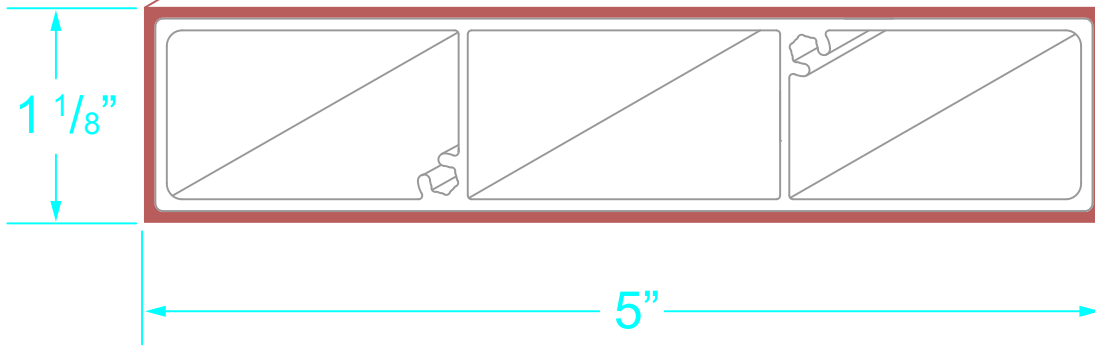

Soleo 6031

Geolam
Architectural Eco-Technology

Title
Hybrid Aluminum/WPC
Soleo 6031

Drawn RP Revision

Date 3/4/19 Date