

Trim Length: - Per customers specification
Weight per lineal ft.: - Soleo 1263 = 1.11 lbs

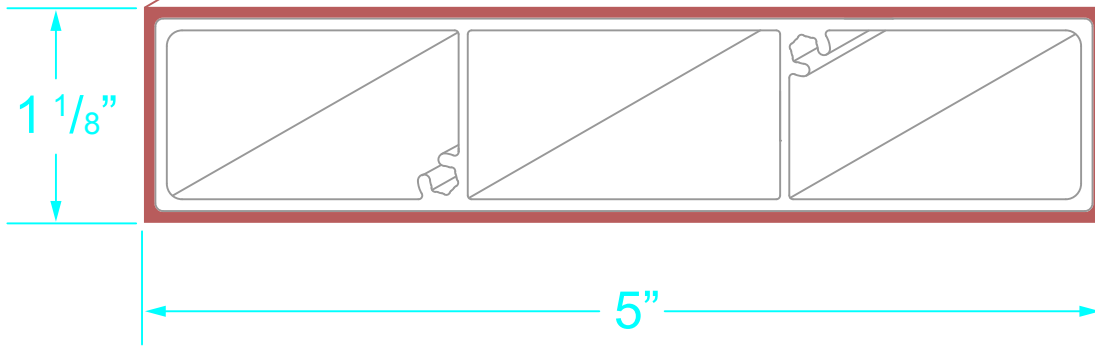

Soleo 1263

Geolam
Architectural Eco-Technology

Title
Hybrid Aluminum/WPC
Soleo 1263

Drawn BR Revision A

Date 3/10/17 Date 3/21/17