

DEPLOYMENT PROCEDURES (OPTION 2)

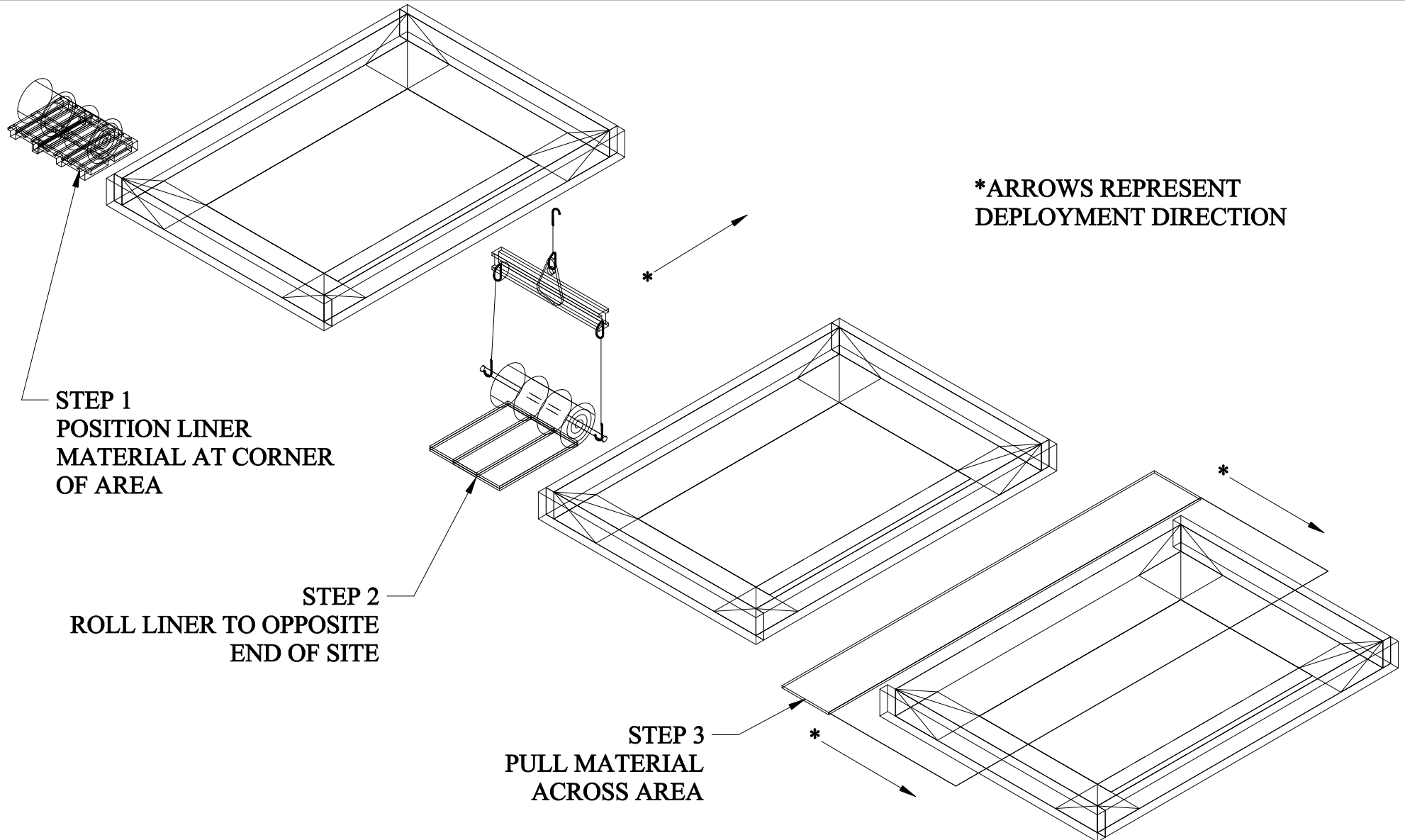

NOTE: This document provides information related to the installation of Griffolyn® material. This document does not attempt to address all aspects of an installation for all application. The information presented is general information in order to familiarize the individual with the overall scope of the project.