

SIDE ELEVATION OF DOOR

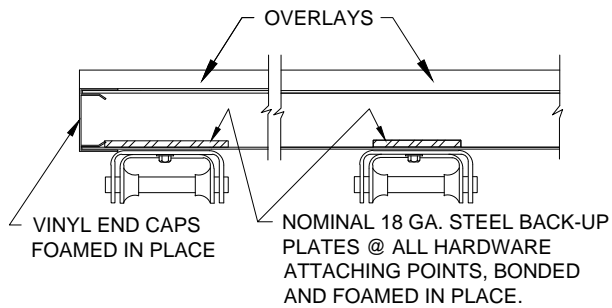

HINGE DETAIL

ADDITIONAL NOTES:

AVAILABLE SECTION HEIGHTS ARE 18", 21", AND 24", INSULATED BY FOAMING-IN-PLACE WITH HIGH DENSITY POLYURETHANE FOAM, MINIMUM 2.20 LBS./CUBIC FT.. EACH SECTION IS CONSTRUCTED TO PROVIDE FOR FULL THERMAL BREAK AT TOP, BOTTOM AND ENDS OF SECTION. NOMINAL THICKNESS OF SECTION WITH OVERLAYS TO BE 2". STEEL SKINS TO BE PRE-PAINTED WITH A URETHANE PRIMER BASE COAT AND A BAKED-ON POLYESTER TOP COAT.

MODEL NUMBER

931

320 Sycamore St.
Wauseon, Ohio 43567
© Copyright 2017

