

1. NAME PLATE
2. SERIAL # & I.D. PLATE
3. REMOVABLE ACCESS PANEL
4. LIGHT SWITCH LEFT OR RIGHT (OPT)
5. LED LIGHT FIXTURE 115V UL LISTED
6. AIR FOIL
7. BAFFLE SYSTEM
8. RESTRICTED BYPASS

PART NUMBER	DIM "A"	DIM "B"	DIM "C"
12140	30	34	15
12340	36	40	18
12240	48	52	24

NOTE:
ALL ELECTRICAL COMPONENTS
UL AND CSA LISTED

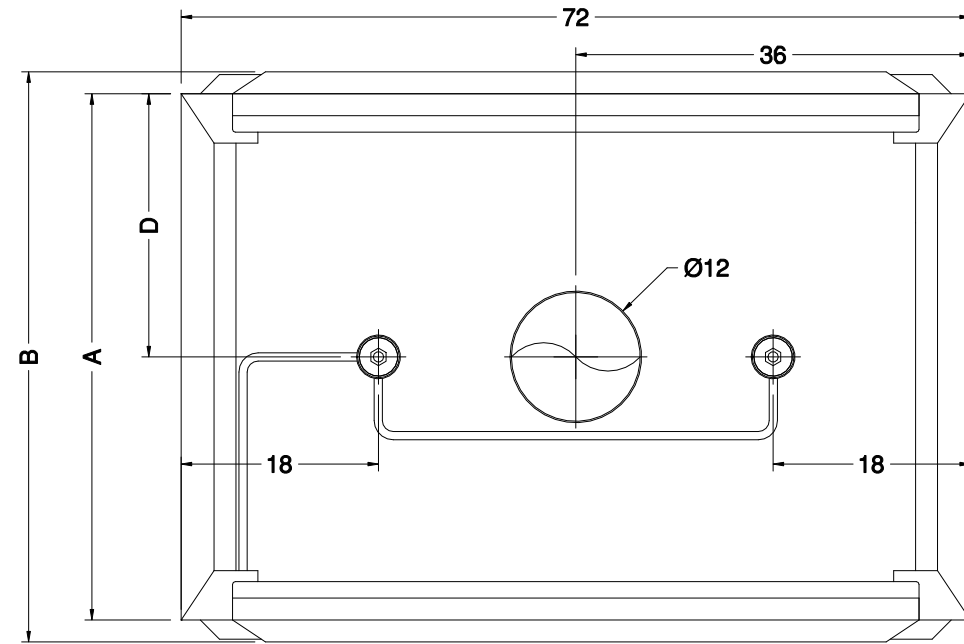

TOP VIEW

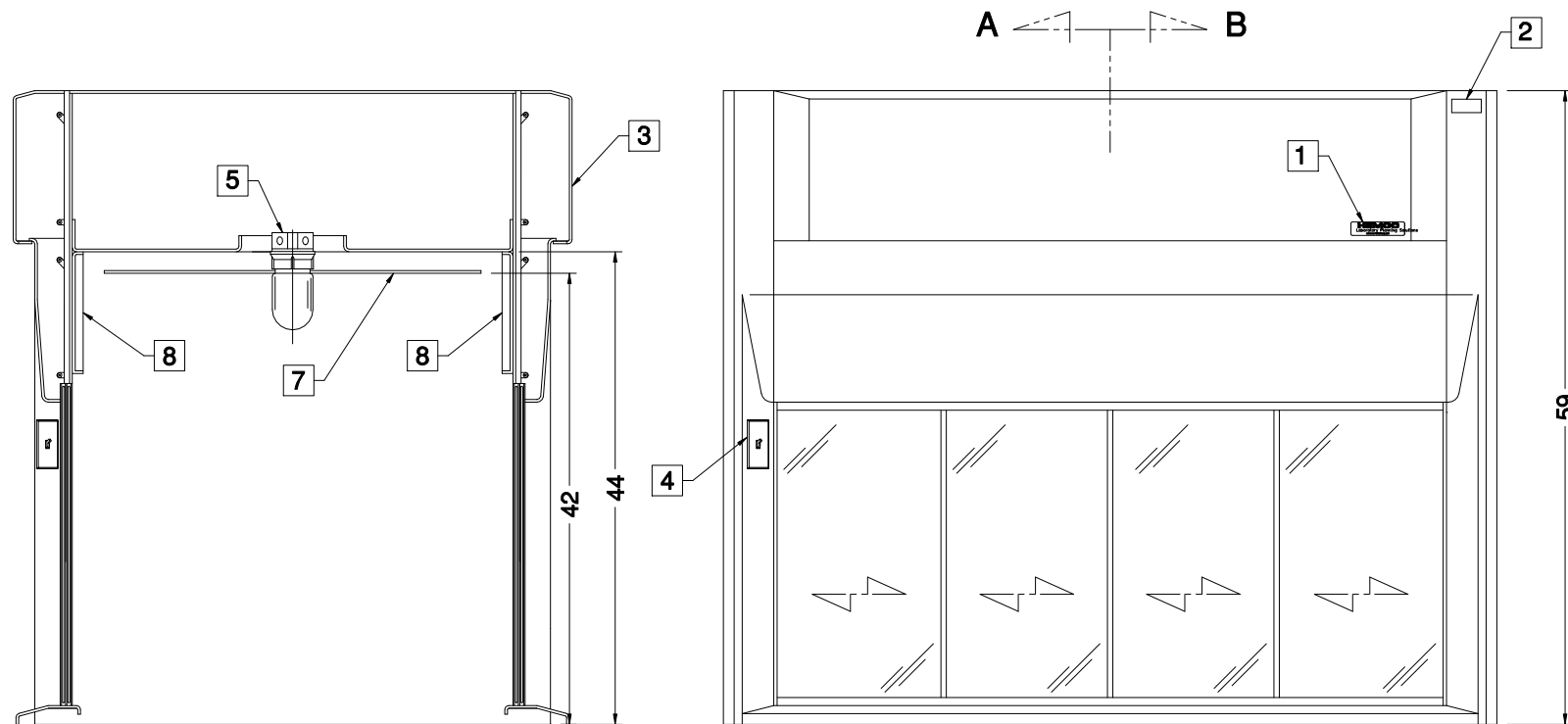

SECTION A-A

FRONT VIEW

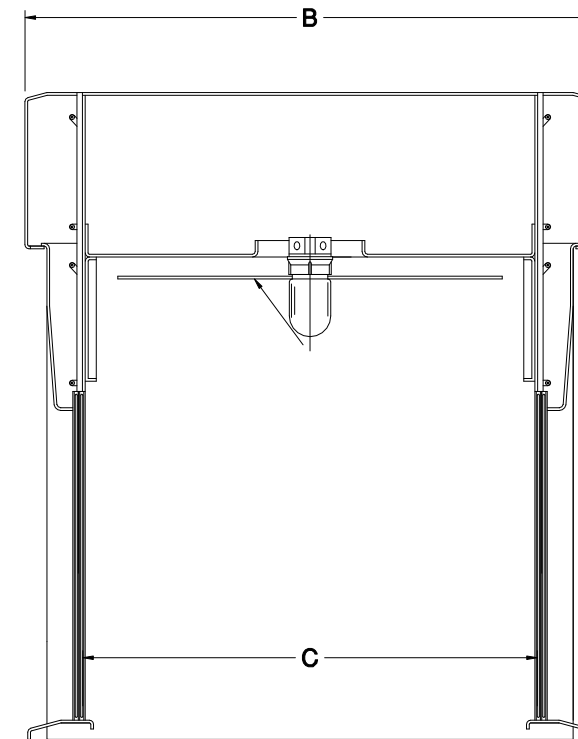

SECTION B-B

**UNIFLOW 72" SE DUAL ENTRY FUME HOOD
WITH VAPOR PROOF LIGHT**

DRAWN BY: **HDK** DATE: **05/11/19** DWG. NO. **LE-DE 72W**

PROPRIETARY AND CONFIDENTIAL
MODEL NO:
THE INFORMATION CONTAINED IN THIS DRAWING IS THE SOLE PROPERTY OF HEMCO CORPORATION. ANY REPRODUCTION IN PART OR AS A WHOLE WITHOUT THE WRITTEN PERMISSION OF HEMCO CORPORATION IS PROHIBITED.
SCALE: **1" = 1'-0"**
PLANS & DRAWINGS ARE COPYRIGHTED BY *R. E. Hill* DATE **02/11/19** SHEET **1** OF **1**

HEMCO
Laboratory Planning Solutions
711 S. Powell Rd.
Independence, MO 64056
PH: 816-796-2900
FAX: 816-796-3333
www.HEMCOcorp.com

REV: **A**